

## 74LVX14

### Low Voltage Hex Inverter with Schmitt Trigger Input

#### General Description

The LVX14 contains six inverter gates each with a Schmitt trigger input. They are capable of transforming slowly changing input signals into sharply defined, jitter-free output signals. In addition, they have a greater noise margin than conventional inverters.

The LVX14 has hysteresis between the positive-going and negative-going input thresholds (typically 1.0V) which is determined internally by transistor ratios and is essentially insensitive to temperature and supply voltage variations.

The inputs tolerate voltages up to 7V allowing the interface of 5V systems to 3V systems.

#### Features

- Input voltage level translation from 5V to 3V
- Ideal for low power/low noise 3.3V applications
- Guaranteed simultaneous switching noise level and dynamic threshold performance

#### Ordering Code:

Order Number	Package Number	Package Description
74LVX14M	M14A	14-Lead Small Outline Integrated Circuit (SOIC), JEDEC MS-012, 0.150" Narrow
74LVX14MX_NL	M14A	Pb-Free 14-Lead Small Outline Integrated Circuit (SOIC), JEDEC MS-012, 0.150" Narrow
74LVX14SJ	M14D	Pb-Free 14-Lead Small Outline Package (SOP), EIAJ TYPE II, 5.3mm Wide
74LVX14MTC	MTC14	14-Lead Thin Shrink Small Outline Package (TSSOP), JEDEC MO-153, 4.4mm Wide
74LVX14MTCX_NL (Note 1)	MTC14	Pb-Free 14-Lead Thin Shrink Small Outline Package (TSSOP), JEDEC MO-153, 4.4mm Wide

Devices also available in Tape and Reel. Specify by appending suffix letter "X" to the ordering code.  
Pb-Free package per JEDEC J-STD-020B.

**Note 1:** "\_NL" indicates Pb-Free package (per JEDEC J-STD-020B). Device available in Tape and Reel only.

**Logic Symbol**

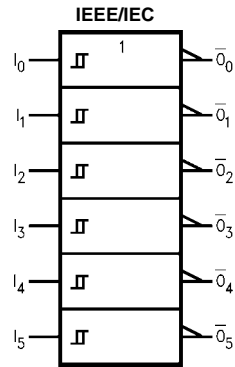

**Connection Diagram**

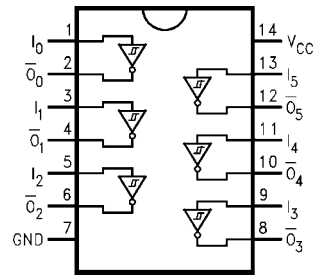

**Pin Descriptions**

Pin Names	Description
$I_n$	Inputs
$\bar{O}_n$	Outputs

**Truth Table**

Input	Output
A	$\bar{O}$
L	H
H	L

**Absolute Maximum Ratings** (Note 2)

Supply Voltage ( $V_{CC}$ )	-0.5V to +7.0V
DC Input Diode Current ( $I_{IK}$ )	
$V_I = -0.5V$	-20 mA
DC Input Voltage ( $V_I$ )	-0.5V to 7V
DC Output Diode Current ( $I_{OK}$ )	
$V_O = -0.5V$	-20 mA
$V_O = V_{CC} + 0.5V$	+20 mA
DC Output Voltage ( $V_O$ )	-0.5V to $V_{CC} + 0.5V$
DC Output Source	
or Sink Current ( $I_O$ )	$\pm 25$ mA
DC $V_{CC}$ or Ground Current	
( $I_{CC}$ or $I_{GND}$ )	$\pm 50$ mA
Storage Temperature ( $T_{STG}$ )	-65°C to +150°C
Power Dissipation	180 mW

**Recommended Operating Conditions** (Note 3)

Supply Voltage ( $V_{CC}$ )	2.0V to 3.6V
Input Voltage ( $V_I$ )	0V to 5.5V
Output Voltage ( $V_O$ )	0V to $V_{CC}$
Operating Temperature ( $T_A$ )	-40°C to +85°C

**Note 2:** The "Absolute Maximum Ratings" are those values beyond which the safety of the device cannot be guaranteed. The device should not be operated at these limits. The parametric values defined in the Electrical Characteristics tables are not guaranteed at the absolute maximum ratings. The "Recommended Operating Conditions" table will define the conditions for actual device operation.

**Note 3:** Unused inputs must be held HIGH or LOW. They may not float.

**DC Electrical Characteristics**

Symbol	Parameter	$V_{CC}$	$T_A = +25^\circ\text{C}$			$T_A = -40^\circ\text{C to } +85^\circ\text{C}$		Units	Conditions	
			Min	Typ	Max	Min	Max			
$V_{T+}$	Positive Threshold	3.0			2.2			V		
$V_{T-}$	Negative Threshold	3.0	0.9				0.9	V		
$V_H$	Hysteresis	3.0	0.3		1.2	0.3	1.2	V		
$V_{OH}$	HIGH Level	2.0	1.9	2.0		1.9		V	$V_{IN} = V_{IL}$ or $V_{IH}$	$I_{OH} = -50 \mu\text{A}$
	Output Voltage	3.0	2.9	3.0		2.9				$I_{OH} = -50 \mu\text{A}$
		3.0	2.58			2.48				$I_{OH} = -4 \text{ mA}$
$V_{OL}$	LOW Level	2.0		0.0	0.1		0.1	V	$V_{IN} = V_{IL}$ or $V_{IH}$	$I_{OL} = 50 \mu\text{A}$
	Output Voltage	3.0		0.0	0.1		0.1			$I_{OL} = 50 \mu\text{A}$
		3.0			0.36		0.44			$I_{OL} = 4 \text{ mA}$
$I_{IN}$	Input Leakage Current	3.6			$\pm 0.1$		$\pm 1.0$	$\mu\text{A}$	$V_{IN} = 5.5V$ or GND	
$I_{CC}$	Quiescent Supply Current	3.6			2.0		20	$\mu\text{A}$	$V_{IN} = V_{CC}$ or GND	

**Noise Characteristics** (Note 4)

Symbol	Parameter	$V_{CC}$ (V)	$T_A = 25^\circ\text{C}$		Units	$C_L$ (pF)
			Typ	Limit		
$V_{OLP}$	Quiet Output Maximum Dynamic $V_{OL}$	3.3	0.3	0.5	V	50
$V_{OLV}$	Quiet Output Minimum Dynamic $V_{OL}$	3.3	-0.3	-0.5	V	50
$V_{IHD}$	Minimum HIGH Level Dynamic Input Voltage	3.3		2.0	V	50
$V_{ILD}$	Maximum LOW Level Dynamic Input Voltage	3.3		0.8	V	50

**Note 4:** Input  $t_r = t_f = 3\text{ns}$

## AC Electrical Characteristics

Symbol	Parameter	V <sub>CC</sub> (V)	T <sub>A</sub> = +25°C			T <sub>A</sub> = -40°C to +85°C		Units	C <sub>L</sub> (pF)
			Min	Typ	Max	Min	Max		
t <sub>PLH</sub>	Propagation Delay Time	2.7		8.7	16.3	1.0	19.5	ns	15
t <sub>PHL</sub>				11.2	19.8	1.0	23.0		50
		3.3 ± 0.3		6.8	10.6	1.0	12.5		15
				9.3	14.1	1.0	16.0		50
t <sub>OSLH</sub>	Output to Output	2.7			1.5		1.5	ns	50
t <sub>OSSL</sub>	Skew (Note 5)	3.3			1.5		1.5		

**Note 5:** Parameter guaranteed by design.  $t_{OSLH} = |t_{PLHm} - t_{PLHn}|$ ,  $t_{OSSL} = |t_{PHLm} - t_{PHLn}|$

## Capacitance

Symbol	Parameter	T <sub>A</sub> = +25°C			T <sub>A</sub> = -40°C to +85°C		Units
		Min	Typ	Max	Min	Max	
C <sub>IN</sub>	Input Capacitance		4	10		10	pF
C <sub>PD</sub>	Power Dissipation Capacitance (Note 6)		21				pF

**Note 6:** C<sub>PD</sub> is defined as the value of the internal equivalent capacitance which is calculated from the operating current consumption without load.

$$\text{Average operating current can be obtained by the equation: } I_{CC(\text{opr.})} = \frac{C_{PD} \times V_{CC} \times f_{IN} + I_{CC}}{6 \text{ (per Gate)}}$$

**Physical Dimensions** inches (millimeters) unless otherwise noted

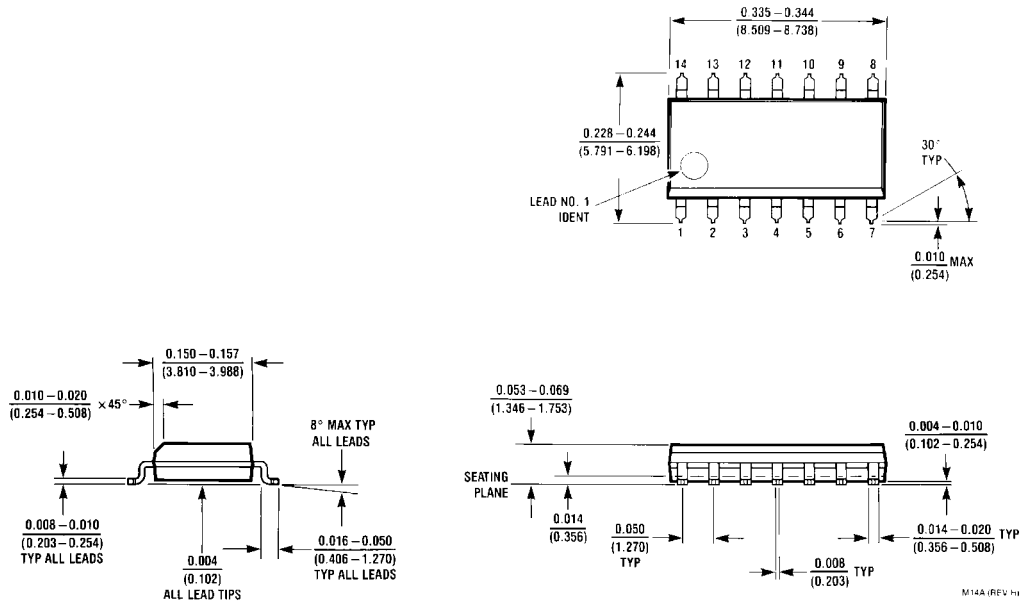

**14-Lead Small Outline Integrated Circuit (SOIC), JEDEC MS-012, 0.150" Narrow  
Package Number M14A**

M14A (REV. H)

**Physical Dimensions** inches (millimeters) unless otherwise noted (Continued)

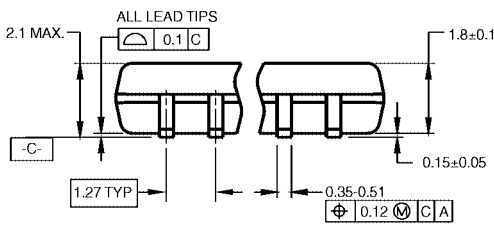
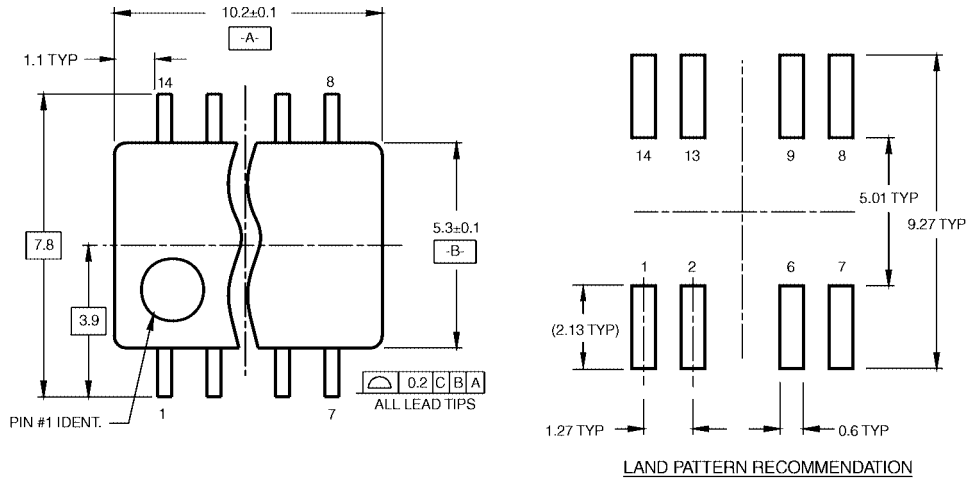

DIMENSIONS ARE IN MILLIMETERS

- NOTES:  
 A. CONFORMS TO EIAJ EDR-7320 REGISTRATION, ESTABLISHED IN DECEMBER, 1998.  
 B. DIMENSIONS ARE IN MILLIMETERS.  
 C. DIMENSIONS ARE EXCLUSIVE OF BURRS, MOLD FLASH, AND TIE BAR EXTRUSIONS.

M14DRevB1

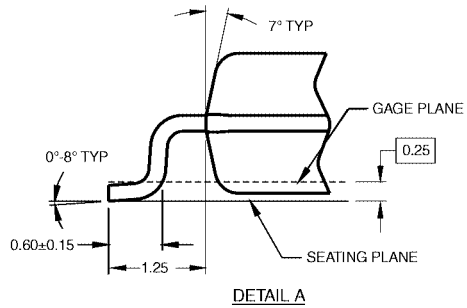
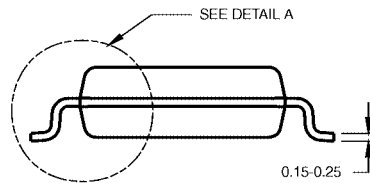

**Pb-Free 14-Lead Small Outline Package (SOP), EIAJ TYPE II, 5.3mm Wide  
 Package Number M14D**

**Physical Dimensions** inches (millimeters) unless otherwise noted (Continued)

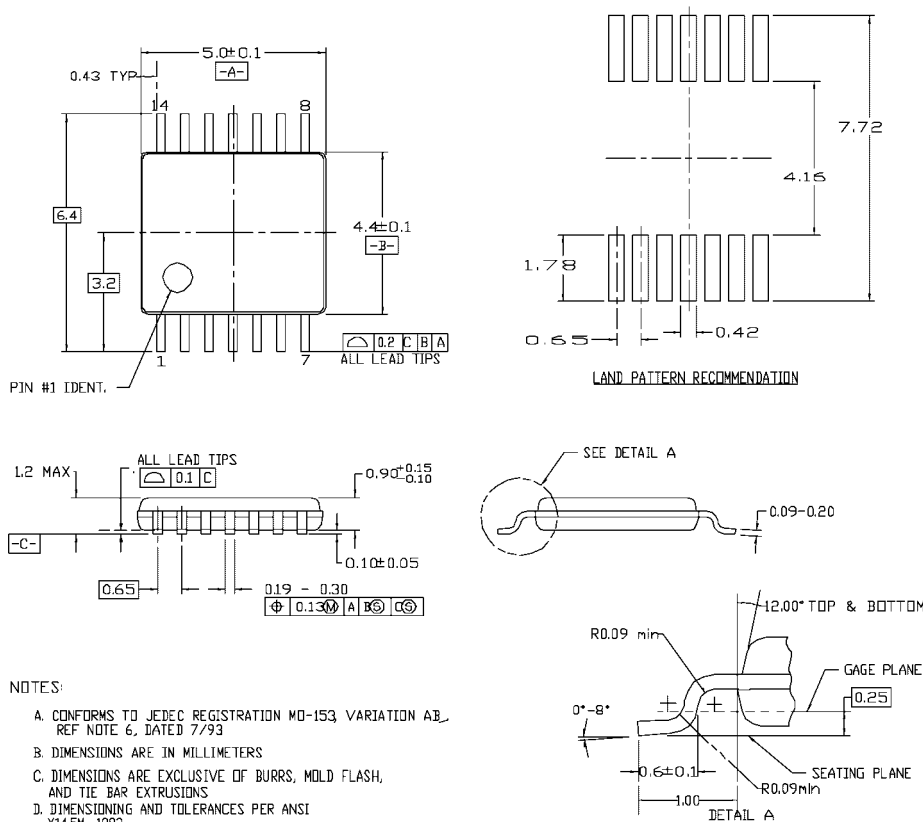

- NOTES:
- A. CONFORMS TO JEDEC REGISTRATION MO-153, VARIATION AB, REF NOTE 6, DATED 7/93
  - B. DIMENSIONS ARE IN MILLIMETERS
  - C. DIMENSIONS ARE EXCLUSIVE OF BURRS, MOLD FLASH, AND TIE BAR EXTRUSIONS
  - D. DIMENSIONING AND TOLERANCES PER ANSI Y14.5M, 1982

MTC14revD

**14-Lead Thin Shrink Small Outline Package (TSSOP), JEDEC MO-153, 4.4mm Wide Package Number MTC14**

Fairchild does not assume any responsibility for use of any circuitry described, no circuit patent licenses are implied and Fairchild reserves the right at any time without notice to change said circuitry and specifications.

**LIFE SUPPORT POLICY**

FAIRCHILD'S PRODUCTS ARE NOT AUTHORIZED FOR USE AS CRITICAL COMPONENTS IN LIFE SUPPORT DEVICES OR SYSTEMS WITHOUT THE EXPRESS WRITTEN APPROVAL OF THE PRESIDENT OF FAIRCHILD SEMICONDUCTOR CORPORATION. As used herein:

1. Life support devices or systems are devices or systems which, (a) are intended for surgical implant into the body, or (b) support or sustain life, and (c) whose failure to perform when properly used in accordance with instructions for use provided in the labeling, can be reasonably expected to result in a significant injury to the user.
2. A critical component in any component of a life support device or system whose failure to perform can be reasonably expected to cause the failure of the life support device or system, or to affect its safety or effectiveness.

[www.fairchildsemi.com](http://www.fairchildsemi.com)