

Flat panel sensor

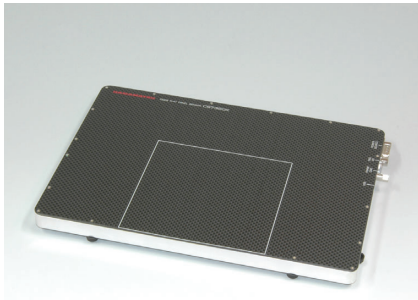

C9732DK-11

For soft X-ray imaging, cassette type with USB 2.0 interface
Large photodiode area: 120 × 120 mm

The C9732DK-11 is two-dimensional CMOS image sensor module designed for X-ray imaging which requires high resolution, large area and wide dynamic range. A target material of X-ray source and X-ray energy adequate for the sensor is Mo and 17 keV. The device shape is thin cassette which incorporate on-chip high-resolution scintillator and a control board. An on-board USB 2.0 interface can realize fast data transfer with the C9732DK-11.

Features

- 2400 × 2400 pixels (50 μm pitch)
- High resolution
- 14-bit digital output (USB 2.0 interface)
- High-speed imaging: 1 frame/s
- No dead area (insensitive area) due to seamless structure
- Compatible with Hamamatsu API (DCAM-API)

Applications

- X-ray imaging (optimized to 17 keV)

Structure

The C9732DK-11 is comprised of a sensor board and a control board. Mounted on the sensor board is a CMOS image sensor chip made up of a two-dimensional photodiode array, row-scanning vertical shift register, and 8 charge amplifier arrays. Each charge amplifier array has a horizontal shift register and consists of 300 ch charge amplifiers with CDS circuit.

CsI scintillator is directly deposited on the two-dimensional photodiode array. X-rays incident on the scintillator are converted to fluorescence, which then enters the two-dimensional photodiode array where electric charge is accumulated in each pixel according to the light intensity. The accumulated charge on each row is sequentially selected by the row-scanning vertical shift register, transferred to the amplifiers through the data line, and converted to a voltage signal. Then an analog signal is sent out from each amplifier array by scanning the horizontal shift register.

The control board converts the analog signal into a 14-bit digital signal, which is then output to a PC through the USB 2.0 interface.

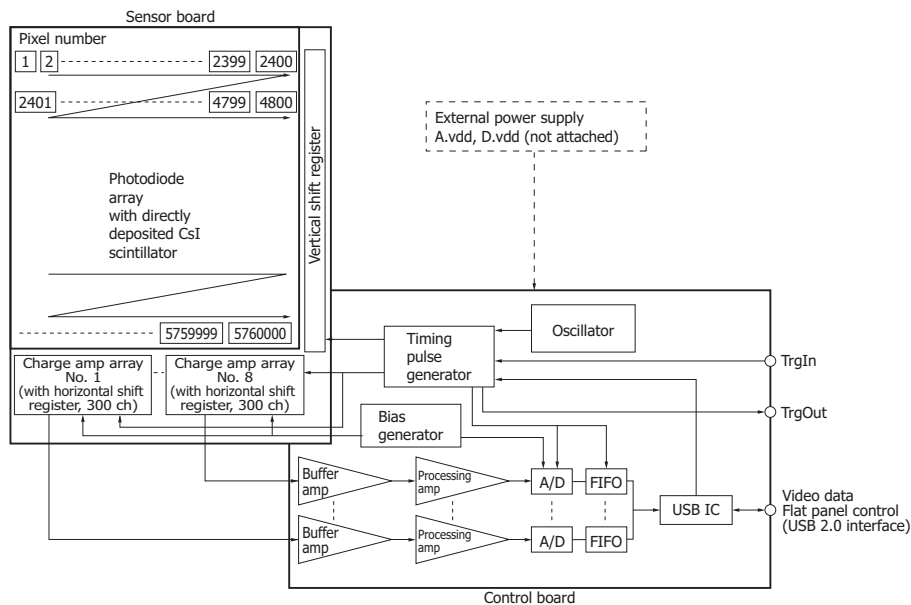

Note: Signals are read out in order of pixel number.

KACCC0310EC

Structure

Parameter	Specification	Unit
Pixel size	50 × 50	μm
Photodiode area	120 × 120	mm
Number of pixels	2400 × 2400	pixels
Number of active pixels	2368 × 2340	pixels
Readout	Charge amplifier array	-
Video output	USB 2.0, 14-bit	-
TrgIn, TrgOut	TTL	-
Scintillator	Direct deposition CsI	-

Absolute maximum ratings (Ta=25 °C)

Parameter	Symbol	Value	Unit
Supply voltage for digital circuitry (+5 V)	D.vdd	+6.0	V
Supply voltage for analog circuitry (+5 V)	A.vdd	+6.0	V
Operating temperature*1	Topr	0 to +40	°C
Storage temperature*1	Tstg	-10 to +60	°C
Incident X-ray energy	-	35	kVp

*1: No condensation

Specifications (Ta=25 °C, A.vdd=5.0 V, D.vdd=5.0 V)

Parameter	Symbol	Min.	Typ.	Max.	Unit
Frame rate max.	Sf(max)	0.95	1	-	frames/s
Frame rate	Sf	-	0.5 to Sf(max)	-	frames/s
Noise (rms)*2	N(rms)	-	1250	-	electrons
Sensitivity*3	S	52 (5.9)	65 (7.4)	-	LSB/mR (LSB/μGy)
Resolution*4	Reso	9	10	-	line pairs/mm
Saturation charge	Csat	-	6.4	-	M electrons
Dynamic range	-	-	5100	-	-
Defect line*5	-	-	-	16	lines
Adjacent defect line	-	-	-	1	line pair
Blemish*6	-	-	-	600	μm
Non-uniformity of sensitivity*6	-	-	-	4	%
Defect cluster*6	-	Not allowed			-
Bright line output adjacent to a defect line (vertical)*6	-	-	-	105	%
Bright line output adjacent to a defect line (horizontal)*6	-	-	-	120	%
Output offset*7	-	-	260	800	LSB

*2: Internal trigger mode at Sf(max)

*3: Mo target 30 kV, without filter

*4: Spatial frequency at CTF=5 %

*5: A defect line is a horizontal or vertical line containing 4 or more cosecutive pixels located at the opposite side of an amplifier array or a shift register, that produce 1/8 of the average sensitivity of the surrounding pixels.

*6: See P.8, "Description of terms"

*7: Average of all active pixels at Sf(max)

Note: X-ray energy range is less than 35 kVp (17 keV Mo source).

Resolution

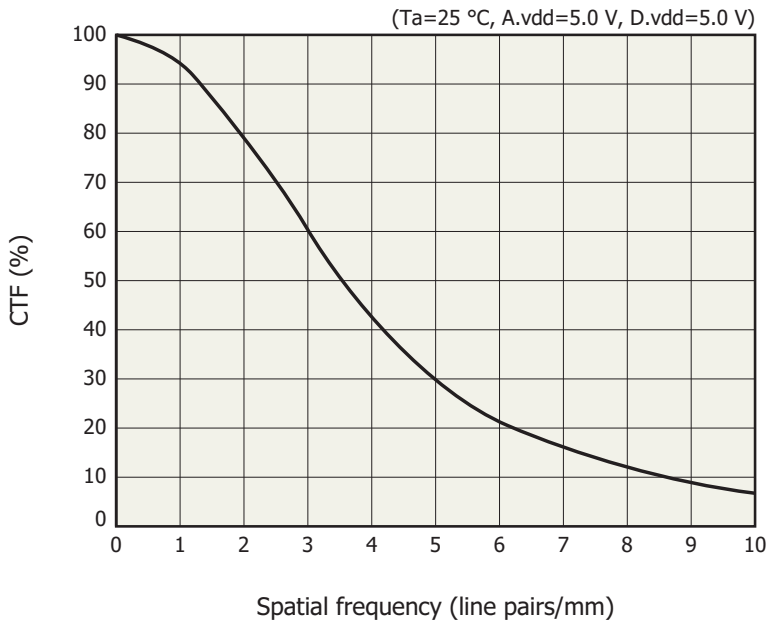

Timing chart

External trigger mode

To acquire images in external trigger mode, input an external trigger pulse as shown below. When used in synchronization with a pulsed X-ray source, X-rays should be irradiated during the Txray period.

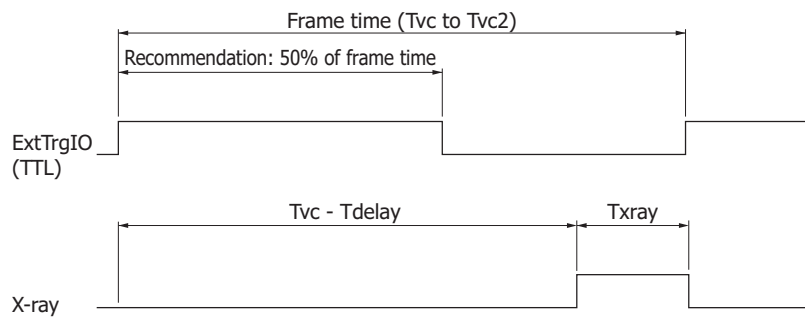

Parameter	Value	Unit
Tdelay (Delay time)	830	µs
Tvc (Cycle time min.)	1000	ms
Tvc2 (Cycle time max.)	2000	ms

(Typ.)

Note: The number of significant figures is two. (except Tvc)

Accessories

- Power cable (terminated with a JSTJ-C9-2C plug at one end and open at the other end; 2 m; see Table 1.)
- External trigger cable (terminated with an FGG.0B.304.CLAD56 plug at one end and open at the other end; 5 m; see Table 2.)
- Earth cable (AWG18; 4 m)

System requirements

To operate the C9732DK-11 at full performance, the following system and peripherals are required.

- PC (recommended system requirements)
 - PC: Precision T5600 standard model (Dell)
 - OS: See "Compatibility Note.pdf" in "<http://www.dcamapi.com>".
 - CPU: Intel®Xeon® Processor E5-2620
(15 M Cache, 2.00 GHz, 7.20 GT/s Intel® QPI)
 - Memory: 4 GB (2 GB × 2) for 32-bit OS
8 GB (2 GB × 4) for 64-bit OS
DDR RDIMM memory (1600 MHz, ECC)
 - Microsoft.net Framework: Version 2.0 and later
- Power source: A.vdd = +5.0 ± 0.1 V (1100 mA), D.vdd = +5.0 ± 0.1 V (350 mA)
 - The voltages described above are specified at the flat panel sensor side.
 - Please use a low noise series power supply. (Avoid using a switching power supply.)
 - Install a noise filter on the AC power input line to prevent surges on the AC line.
 - Always ground the ground terminal to avoid the effects of noise from peripheral devices.
- DCAM-API (digital camera application programming interface): produced by Hamamatsu
 - The driver software, DLL are included in DCAM-API. DCAM-SDK which includes function manuals and sample software can be provided to OEM users.
 - The latest version of DCAM-API can be downloaded from "<http://dcam-api.com>"
- USB cable: mini-B type

[Table 1] Pin assignment and cable color for 9-pin power receptacle

Pin No.	Color	Signal
1	Yellow	Digital GND
2	Blue	Digital GND
3	Gray	Analog GND
4	Black	Analog GND
5	Red	Analog GND
6	Green	Digital +5 V
7	Purple	Digital +5 V
8	White	Analog +5 V
9	Brown	Analog +5 V

9-pin receptacle: DE-9PF-N made by JAE (Japan Aviation Electronics Industry, Limited)
Mating plug: JST J-C9-2C made by JST Mfg. Co., Ltd.

[Table 2] Pin assignment and color cable for 4-pin trigger cable

Pin No.	Color	Signal	Note
1	Blue	TrgIn	Twist pair
2	Orange	Digital GND	
3	Green	TrgOut	Twist pair
4	Brown	Digital GND	

4-pin receptacle: ECG.0B.304.CLL made by LEMO S.A.
Mating plug: FGG.0B.304.CLAD56 made by LEMO S.A.

[Table 3] Trigger mode

Trigger mode	TrgIn (See Table 2)	Note
External trigger mode	Rectangular signal	The integration time is controlled through Lemo 4-pin trigger cable.
Internal trigger mode	High or Open	The integration time is controlled by DCAM command without Lemo 4-pin trigger cable.

[Table 4] Trigger mode selection by DCAM-API

Function: `BOOL dcam_setpropertyvalue(HDCAM h, int32 iProp, double fValue);`

Trigger mode	iProp	fValue
External trigger mode	DCAM_IDPROP_TRIGGERSOURCE	DCAMPROP_TRIGGERSOURCE_EXTERNAL
Internal trigger mode	DCAM_IDPROP_TRIGGERSOURCE	DCAMPROP_TRIGGERSOURCE_INTERNAL
Internal trigger mode (exposure time)	DCAM_IDPROP_EXPOSURETIME	Exposuretime(sec)

Note: The iProp which is not indicated in this table cannot be used.

Connection

After installing DCAM-API in a PC with a USB 2.0 port, connect the C9732DK-11 to that PC.

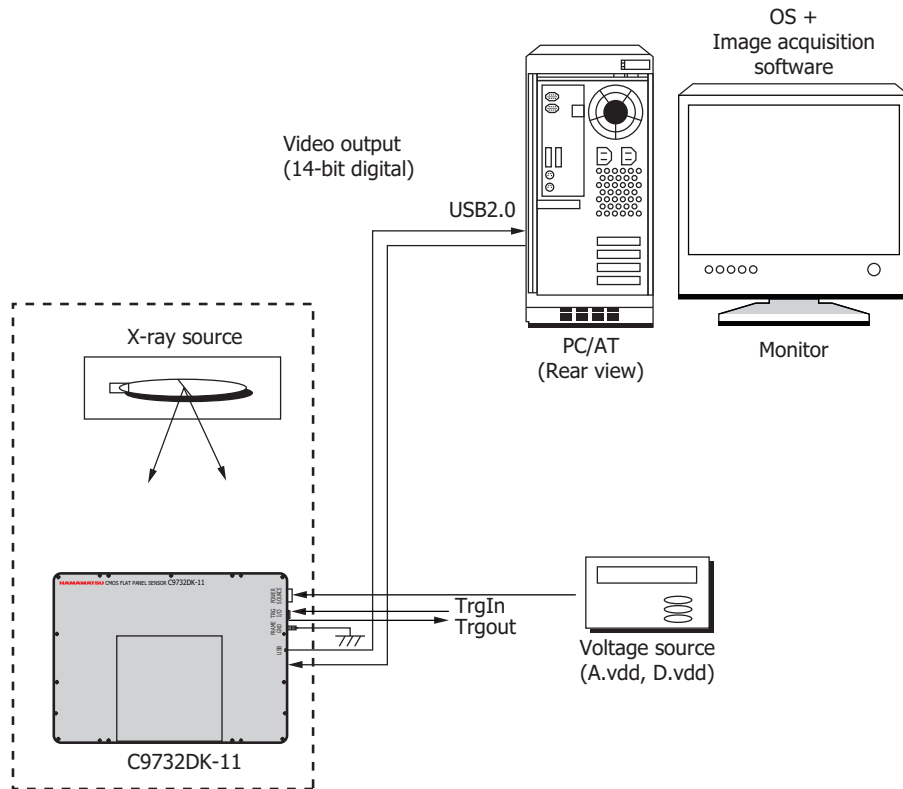

KACCC0544EA

Dimensional outline (unit: mm, tolerance: ± 1 mm unless otherwise noted)

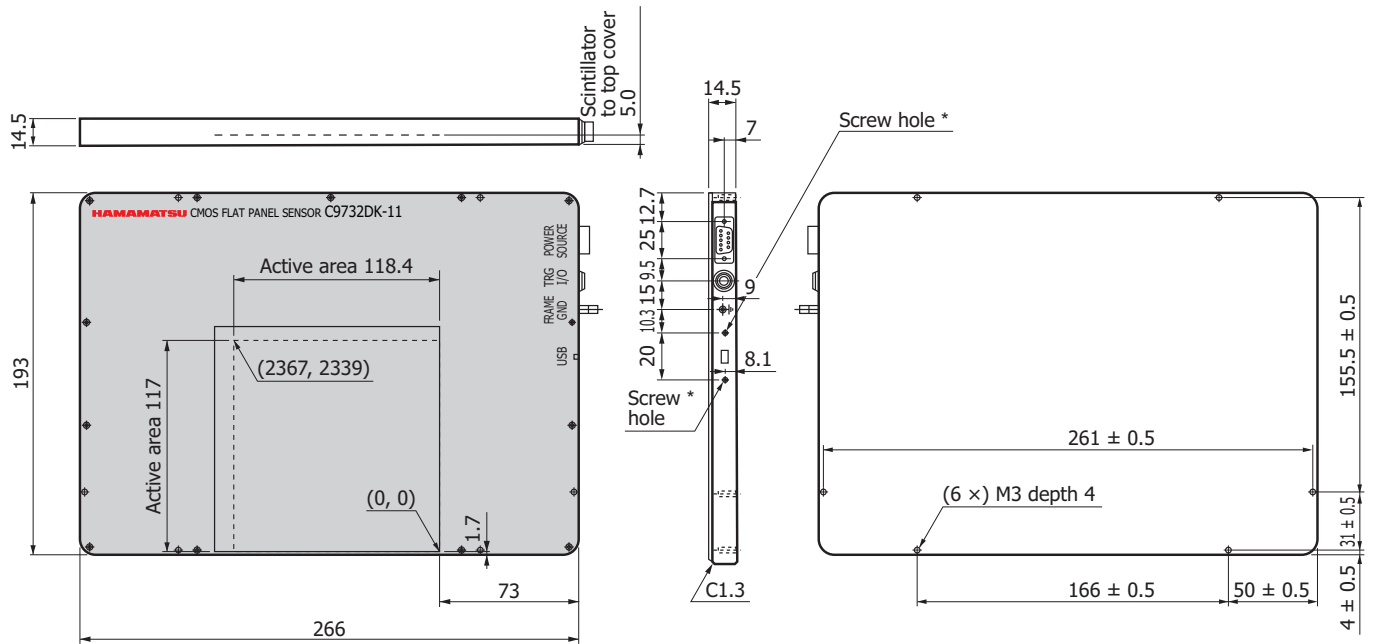

Top cover material including window is carbon fiber (1.0 mm thickness).

Weight: 1.2 kg

* M3 screw hole for fixing USB plug to flat panel sensor.

The depth of the hole: 7 mm

KACCA0277EA

Notice

- Do not subject the flat panel sensors to strong vibration or shock (Strong shock such as drop impacts may cause permanent damage to these sensors).
- Users must take responsibility for implementing X-ray shielding safety measures to avoid the risk of X-ray exposure.
- Data listed in this datasheet is defined at the time of shipment. Characteristics may vary somewhat due to exposure to X-rays so take proper countermeasures such as making periodic image correction.
- This product is warranted for a period of 12 months after the date of the shipment. The warranty is limited to replacement or repair of any defective product due to defects in workmanship or materials used in manufacture. The warranty does not cover loss or damage caused by natural disaster, misuse (including modifications and any use not complying with the environment, application, usage and storage conditions described in this datasheet), or total X-ray radiation dose over 45000 R (390 Gy) even within the warranty period [incident X-ray energy: less than 35 kVp (17 keV Mo source)].

Description of terms

☒ **Blemish**

Length of pixel cluster which has less than 90 % of the average sensitivity of the surrounding pixels.

☒ **Bright line output adjacent to a defect line**

The relative sensitivity ratio "a/b" should be 105 % or less for vertical lines, 120 % or less for horizontal lines, where "a" and "b" are defined as follows:

- a: Average sensitivity of bright line (Line A) adjacent to defect line
- b: Average sensitivity of standard line (Line B) adjacent to Line A

Note that the average sensitivity of the bright line is calculated from the region adjacent to the defect region in the defect line.

Example: See the right figure

Defect region in defect line: From pixel (J, 1) to pixel (J, 15)

- a: Average sensitivity from pixel (I, 1) to pixel (I, 15) or from pixel (K, 1) to pixel (K, 15)
- b: Average sensitivity from pixel (H, 1) to pixel (H, 15) or from pixel (L, 1) to pixel (L, 15)

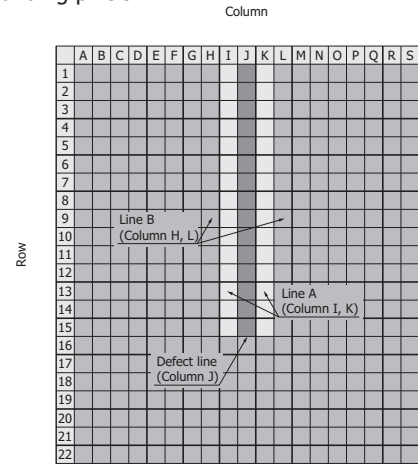

KACCC0385EB

☒ **Defect cluster**

Formed with more than 3 × 3 pixels which have less than 1/8 of the average sensitivity of the surrounding pixels.



This is defined as defect cluster. This is not defined as defect cluster.

□ Normal pixel ■ Defective pixel

KACCC0384EB

☒ **Nonuniformity of sensitivity**

16 × 16 segments are 16 × 16-divided active area excluded 1 mm from the whole edge. Xij is defined as the average sensitivity of each segment.

Uniformity of sensitivity is calculated as following equation.

$$\text{Nonuniformity of sensitivity} = \frac{\sigma}{\bar{x}}$$

- σ: standard deviation of 16 × 16 "Xij"
- \bar{x} : average value of 16 × 16 "Xij"

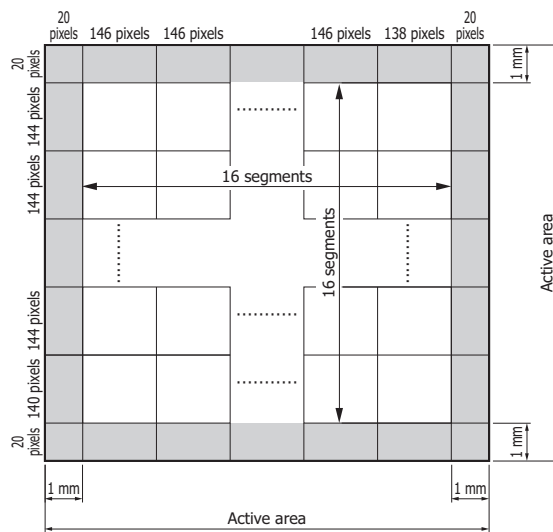

KACCC0447EA

Information described in this material is current as of February, 2015.

Product specifications are subject to change without prior notice due to improvements or other reasons. This document has been carefully prepared and the information contained is believed to be accurate. In rare cases, however, there may be inaccuracies such as text errors. Before using these products, always contact us for the delivery specification sheet to check the latest specifications.

The product warranty is valid for one year after delivery and is limited to product repair or replacement for defects discovered and reported to us within that one year period. However, even if within the warranty period we accept absolutely no liability for any loss caused by natural disasters or improper product use.

Copying or reprinting the contents described in this material in whole or in part is prohibited without our prior permission.

HAMAMATSU

www.hamamatsu.com

HAMAMATSU PHOTONICS K.K., Solid State Division

1126-1 Ichino-cho, Higashi-ku, Hamamatsu City, 435-8558 Japan, Telephone: (81) 53-434-3311, Fax: (81) 53-434-5184

U.S.A.: Hamamatsu Corporation: 360 Foothill Road, Bridgewater, N.J. 08807, U.S.A., Telephone: (1) 908-231-0960, Fax: (1) 908-231-1218

Germany: Hamamatsu Photonics Deutschland GmbH: Arzbergerstr. 10, D-82211 Herrsching am Ammersee, Germany, Telephone: (49) 8152-375-0, Fax: (49) 8152-265-8

France: Hamamatsu Photonics France S.A.R.L.: 19, Rue du Saule Trapu, Parc du Moulin de Massy, 91882 Massy Cedex, France, Telephone: 33-(1) 69 53 71 00, Fax: 33-(1) 69 53 71 10

United Kingdom: Hamamatsu Photonics UK Limited: 2 Howard Court, 10 Tewin Road, Welwyn Garden City, Hertfordshire AL7 1BW, United Kingdom, Telephone: (44) 1707-294888, Fax: (44) 1707-325777

North Europe: Hamamatsu Photonics Norden AB: Torshamnsgatan 35 16440 Kista, Sweden, Telephone: (46) 8-509-031-00, Fax: (46) 8-509-031-01

Italy: Hamamatsu Photonics Italia S.r.l.: Strada della Moia, 1 int. 6, 20020 Arese (Milano), Italy, Telephone: (39) 02-93581733, Fax: (39) 02-93581741

China: Hamamatsu Photonics (China) Co., Ltd.: B1201, Jiaming Center, No.27 Dongsanhuan Beilu, Chaoyang District, Beijing 100020, China, Telephone: (86) 10-6586-6006, Fax: (86) 10-6586-2866