

### Typical Applications

The HMC315 / HMC315E is ideal for:

- Fiber Optic OC-48 Systems
- Microwave Test Instrumentation
- Broadband Mobile Radio Platforms

### Features

- Saturated Output Power: +17 dBm
- Output IP3: +33 dBm
- Gain: 15 dB
- Single Supply: +5V to +7V
- Ultra Small Package: SOT26

### Functional Diagram

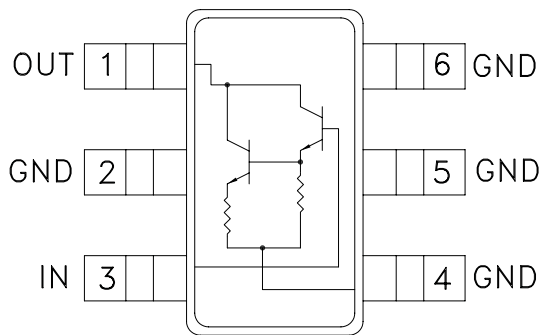

### General Description

The HMC315 & HMC315E are ultra broadband GaAs InGaP Heterojunction Bipolar Transistor (HBT) MMIC amplifiers that operate from a single positive supply. The surface mount SOT26 amplifier can be used as a broadband gain stage, or used with external matching for optimized narrow band applications. The Darlington configuration results in reduced sensitivity to normal process variations and provides a good 50-ohm input/output port match. The amplifier provides 15 dB of gain and +17 dBm of saturated power while operating from a single positive +7V supply.

### Electrical Specifications, $T_A = +25^\circ\text{C}$ , As a Function of $V_{CC}$

Parameter	$V_{CC} = +5V$			$V_{CC} = +7V$			Units
	Min.	Typ.	Max.	Min.	Typ.	Max.	
Frequency Range	DC - 7			DC - 7			GHz
Gain	11	14	17	11	15	18	dB
Gain Variation over Temperature		0.015	0.025		0.015	0.025	dB/°C
Input Return Loss	7	10		7	10		dB
Output Return Loss	3	7		3	7		dB
Reverse Isolation	18	21		18	21		dB
Output Power for 1 dB Compression (P1dB) @ 1.0 GHz	8	11		13	16		dBm
Saturated Output Power (Psat) @ 1.0 GHz	10	13		15	17.5		dBm
Output Third Order Intercept (OIP3) @ 1.0 GHz	23	26		30	33		dBm
Noise Figure		6.5			6.5		dB
Supply Current (Icc)		30			50		mA



## GaAs InGaP HBT MMIC DARLINGTON AMPLIFIER, DC - 7.0 GHz

**Gain & Return Loss @ Vcc= +7V**

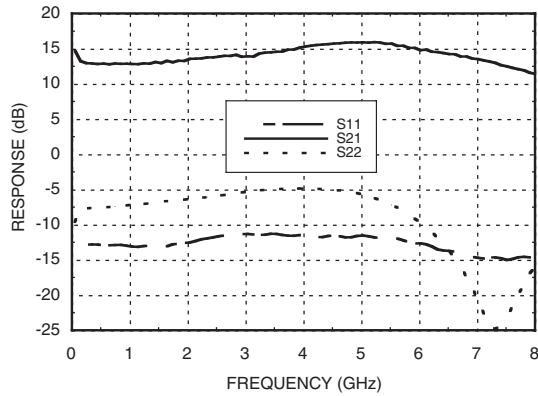

**Gain & Return Loss @ Vcc= +5V**

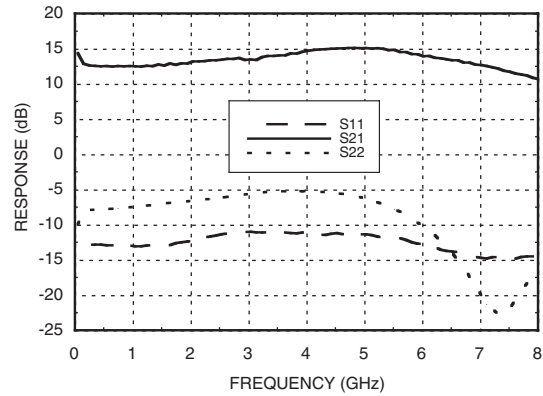

**Gain vs. Temperature @ Vcc= +7V**

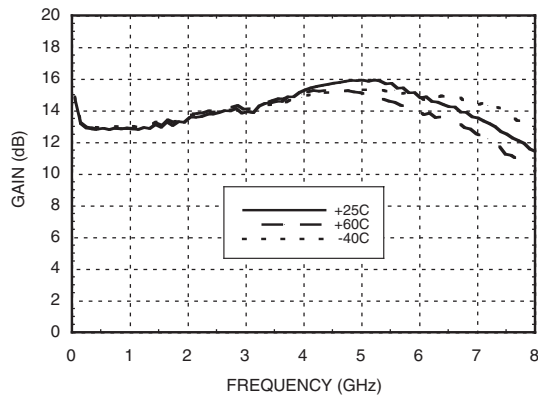

**Gain vs. Temperature @ Vcc= +5V**

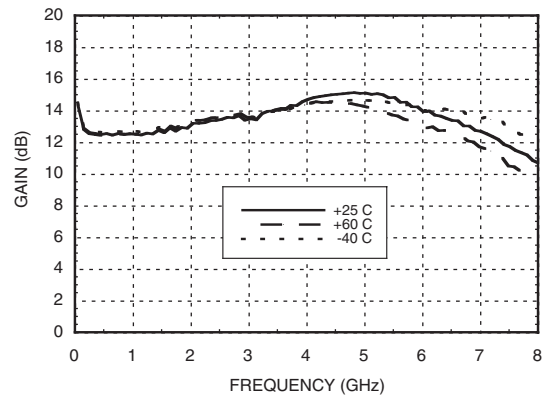

**Input & Output  
Return Loss vs. Vcc Bias**

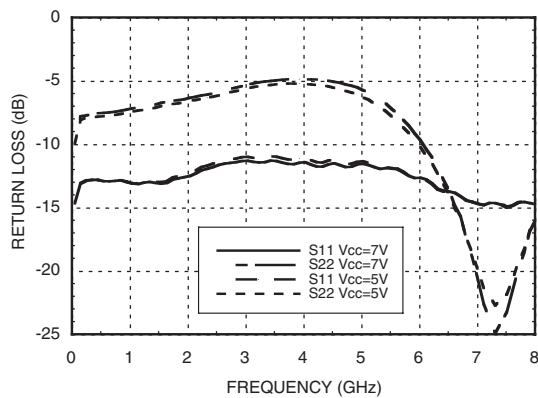

**Reverse Isolation vs. Vcc Bias**

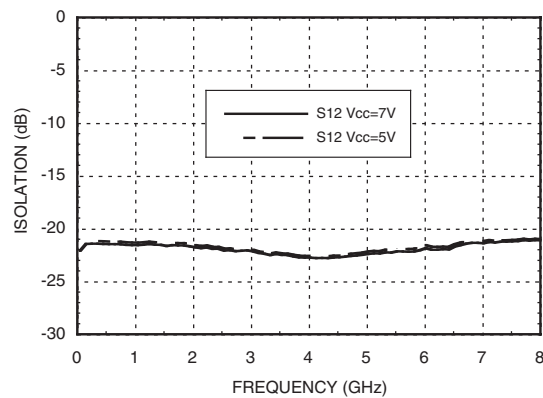

**P1dB vs. Temperature @ Vcc= +7V**

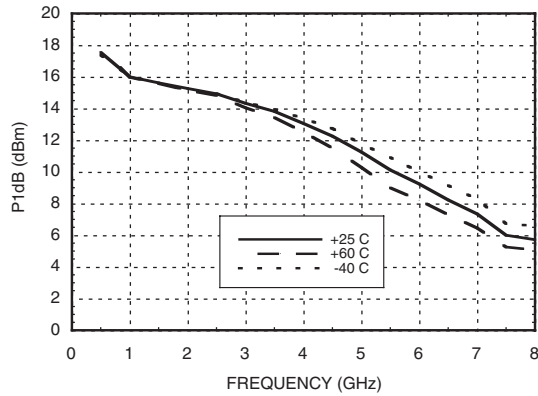

**P1dB vs. Temperature @ Vcc= +5V**

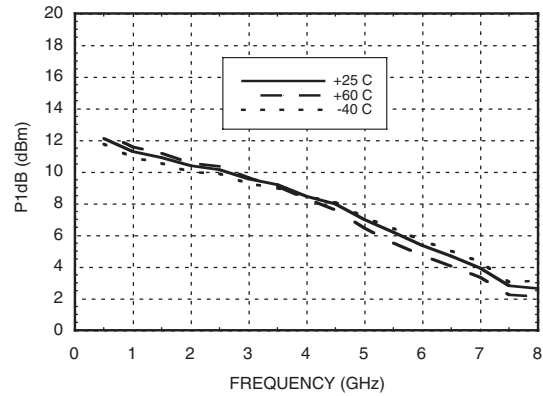

**Psat vs. Temperature @ Vcc= +7V**

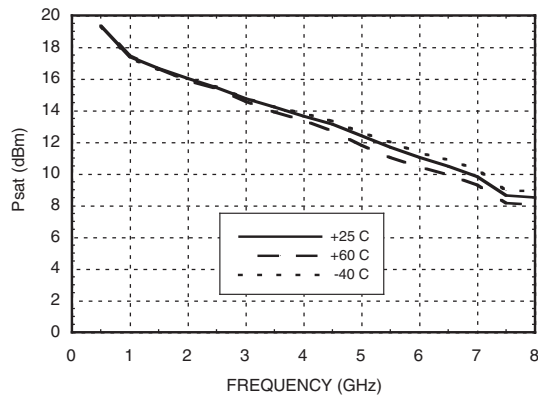

**Psat vs. Temperature @ Vcc= +5V**

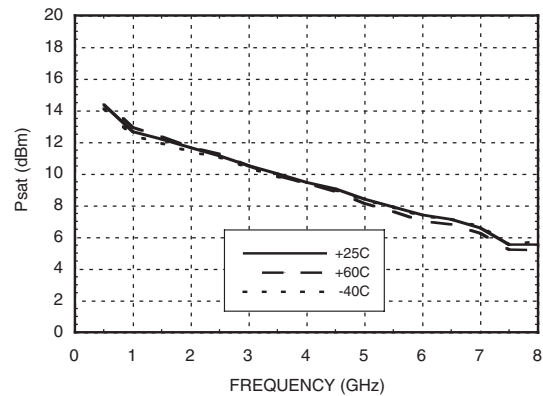

**Output IP3 vs. Temperature @ Vcc= +7V**

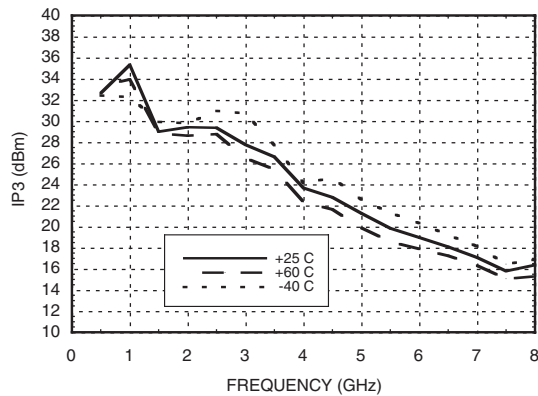

**Output IP3 vs. Temperature @ Vcc= +5V**

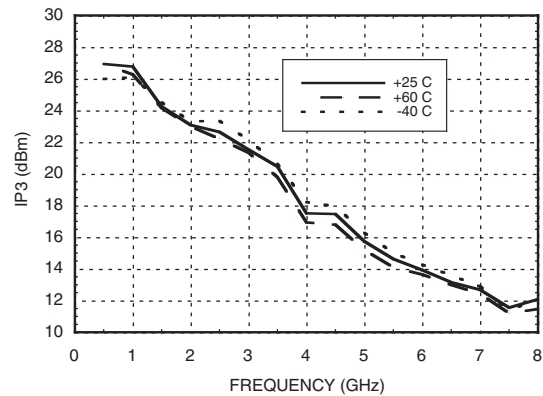



**GaAs InGaP HBT MMIC DARLINGTON  
AMPLIFIER, DC - 7.0 GHz**

**Power Compression  
@ 1.0 GHz, Vcc= +7V**

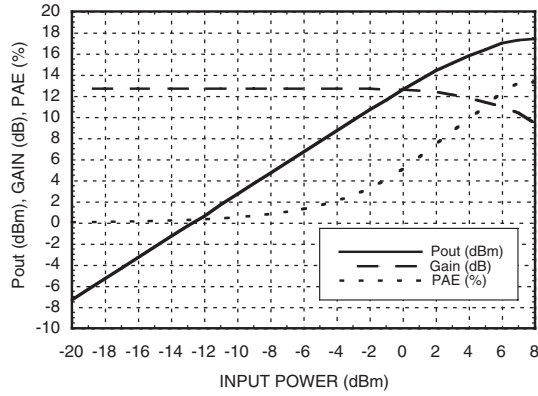

**Power Compression  
@ 1.0 GHz, Vcc= +5V**

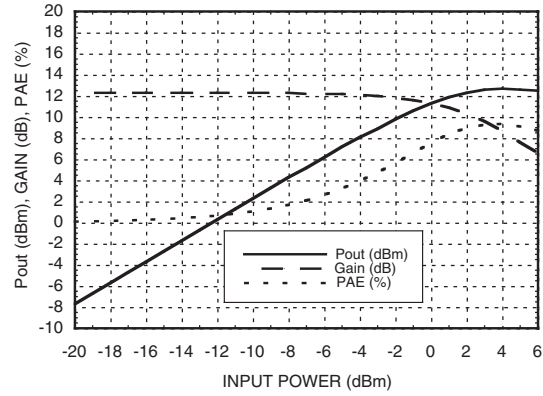

**Power Compression  
@ 3.0 GHz, Vcc= +7V**

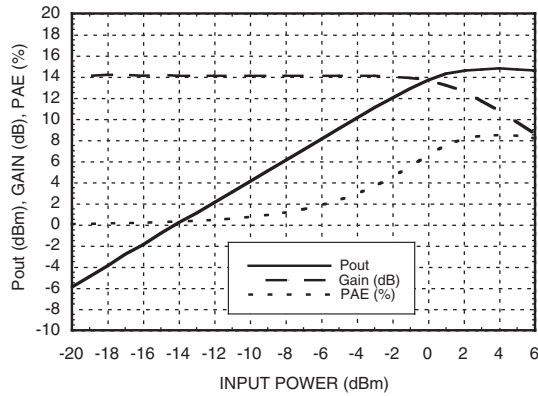

**Power Compression  
@ 3.0 GHz, Vcc= +5V**

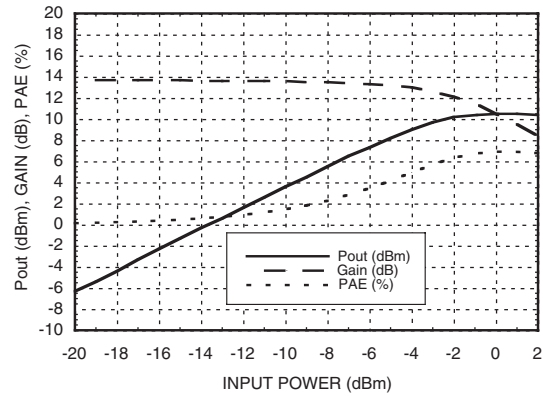

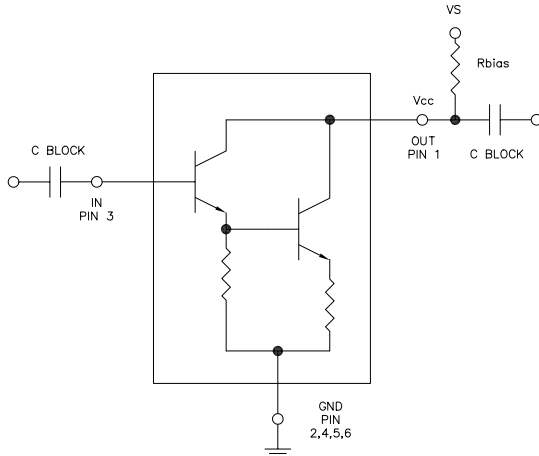

**GaAs InGaP HBT MMIC DARLINGTON  
AMPLIFIER, DC - 7.0 GHz**
**Application Circuit**

Note:

1. Select Rbias to achieve desired Vcc voltage on Pin 1.
2. External Blocking Capacitors are required on Pins 1 & 3.

**Absolute Maximum Ratings**

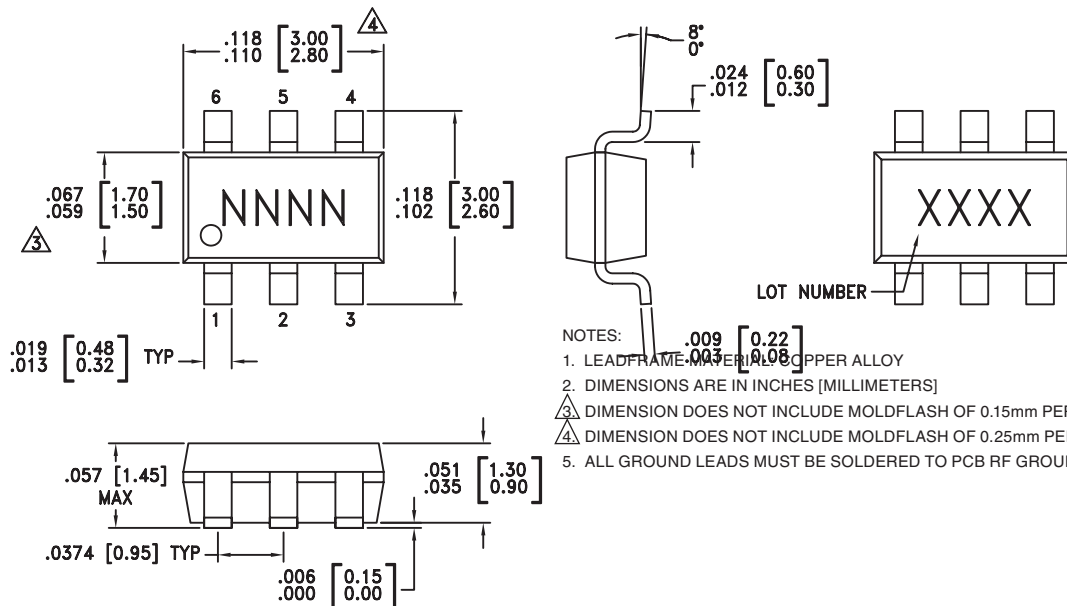
Collector Bias Voltage (Vcc)	+7.5 Vdc
RF Input Power (RFIn)(Vcc = +7.0 Vdc)	+11 dBm
Junction Temperature	150 °C
Continuous P <sub>diss</sub> (T = 60 °C) (derate 4.14 mW/°C above 60 °C)	0.373 W
Thermal Resistance (junction to lead)	242 °C/W
Storage Temperature	-65 to +150 °C
Operating Temperature	-40 to +60 °C
ESD Sensitivity (HBM)	Class 1A

**ELECTROSTATIC SENSITIVE DEVICE  
OBSERVE HANDLING PRECAUTIONS**
**Outline Drawing**

NOTES:

1. LEAD FRAME MATERIAL: COPPER ALLOY
2. DIMENSIONS ARE IN INCHES [MILLIMETERS]
- △ DIMENSION DOES NOT INCLUDE MOLDFLASH OF 0.15mm PER SIDE.
- △ DIMENSION DOES NOT INCLUDE MOLDFLASH OF 0.25mm PER SIDE.
5. ALL GROUND LEADS MUST BE SOLDERED TO PCB RF GROUND

**Package Information**

Part Number	Package Body Material	Lead Finish	MSL Rating	Package Marking <sup>[3]</sup>
HMC315	Low Stress Injection Molded Plastic	Sn/Pb Solder	MSL1 <sup>[1]</sup>	H315 XXXX
HMC315E	RoHS-compliant Low Stress Injection Molded Plastic	100% matte Sn	MSL1 <sup>[2]</sup>	315E XXXX

<sup>[1]</sup> Max peak reflow temperature of 235 °C

<sup>[2]</sup> Max peak reflow temperature of 260 °C

<sup>[3]</sup> 4-Digit lot number XXXX



**Evaluation PCB**

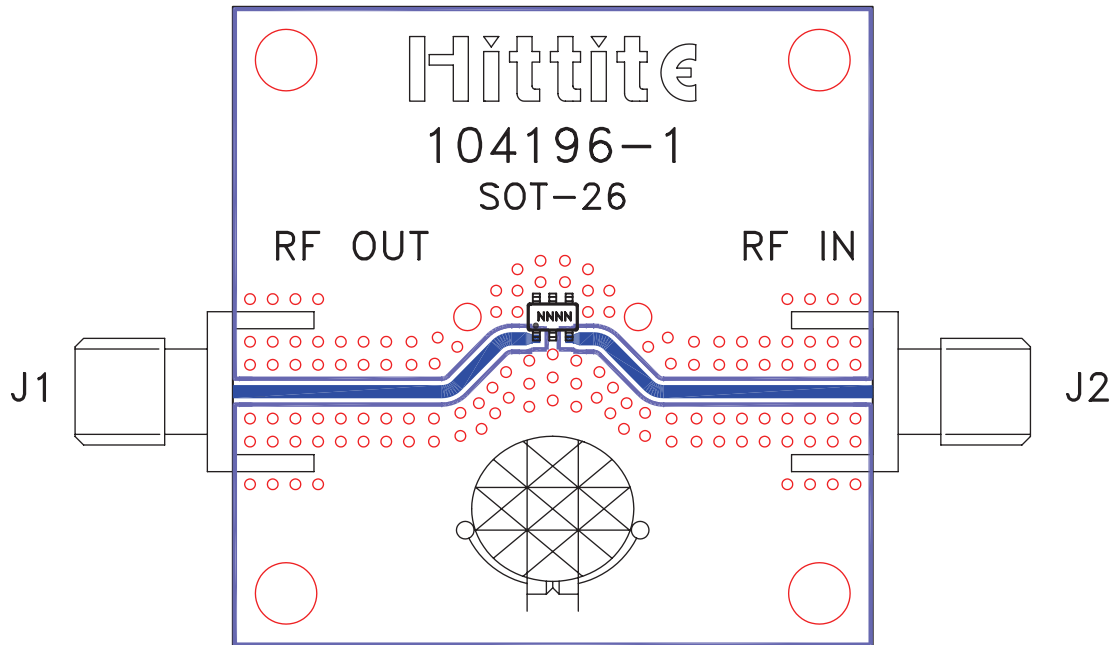

**List of Materials for Evaluation PCB 104217 [1]**

Item	Description
J1, J2	PCB Mount SMA Connector
U1	HMC315 / HMC315E Amplifier
PCB [2]	Evaluation PCB 1.5" x 1.5"

[1] Reference this number when ordering complete evaluation PCB

[2] Circuit Board Material: Roger 4350

The circuit board used in the final application should use RF circuit design techniques. Signal lines should have 50 ohm impedance while the package ground leads should be connected directly to the ground plane similar to that shown. A sufficient number of via holes should be used to connect the top and bottom ground planes. The evaluation circuit board shown is available from Hittite upon request.