

## Standard Rectifier

$$V_{RRM} = 2 \times 1800 \text{ V}$$

$$I_{FAV} = 45 \text{ A}$$

$$V_F = 1.23 \text{ V}$$

Phase leg

Part number

DSP45-18A

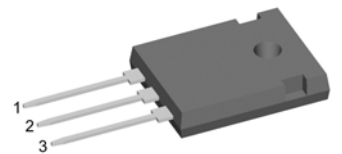

Backside: anode/cathode

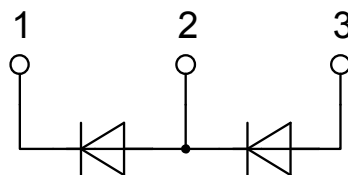

### Features / Advantages:

- Planar passivated chips
- Very low leakage current
- Very low forward voltage drop
- Improved thermal behaviour

### Applications:

- Diode for main rectification
- For single and three phase bridge configurations

### Package: TO-247

- Industry standard outline
- RoHS compliant
- Epoxy meets UL 94V-0

Rectifier				Ratings			
Symbol	Definition	Conditions	min.	typ.	max.	Unit	
$V_{RSM}$	max. non-repetitive reverse blocking voltage	$T_{VJ} = 25^{\circ}C$			1900	V	
$V_{RRM}$	max. repetitive reverse blocking voltage	$T_{VJ} = 25^{\circ}C$			1800	V	
$I_R$	reverse current	$V_R = 1800 V$	$T_{VJ} = 25^{\circ}C$		40	$\mu A$	
		$V_R = 1800 V$	$T_{VJ} = 150^{\circ}C$		1.5	mA	
$V_F$	forward voltage drop	$I_F = 45 A$	$T_{VJ} = 25^{\circ}C$		1.26	V	
					1.57	V	
		$I_F = 90 A$	$T_{VJ} = 150^{\circ}C$		1.23	V	
					1.66	V	
$I_{FAV}$	average forward current	$T_C = 130^{\circ}C$ 180° sine	$T_{VJ} = 175^{\circ}C$		45	A	
$V_{FO}$	threshold voltage	} for power loss calculation only	$T_{VJ} = 175^{\circ}C$		0.81	V	
$r_F$	slope resistance				9.1	m $\Omega$	
$R_{thJC}$	thermal resistance junction to case				0.55	K/W	
$R_{thCH}$	thermal resistance case to heatsink			0.25		K/W	
$P_{tot}$	total power dissipation		$T_C = 25^{\circ}C$		270	W	
$I_{FSM}$	max. forward surge current	t = 10 ms; (50 Hz), sine	$T_{VJ} = 45^{\circ}C$		480	A	
					520	A	
		t = 8,3 ms; (60 Hz), sine	$V_R = 0 V$	$T_{VJ} = 150^{\circ}C$		410	A
						440	A
$I^2t$	value for fusing	t = 10 ms; (50 Hz), sine	$T_{VJ} = 45^{\circ}C$		1.15	kA <sup>2</sup> s	
					1.13	kA <sup>2</sup> s	
		t = 8,3 ms; (60 Hz), sine	$V_R = 0 V$	$T_{VJ} = 150^{\circ}C$		840	A <sup>2</sup> s
						805	A <sup>2</sup> s
$C_J$	junction capacitance	$V_R = 400 V; f = 1 MHz$	$T_{VJ} = 25^{\circ}C$		18	pF	

Package TO-247			Ratings			
Symbol	Definition	Conditions	min.	typ.	max.	Unit
$I_{RMS}$	RMS current	per terminal			70	A
$T_{VJ}$	virtual junction temperature		-40		175	°C
$T_{op}$	operation temperature		-40		150	°C
$T_{stg}$	storage temperature		-40		150	°C
<b>Weight</b>				6		g
$M_D$	mounting torque		0.8		1.2	Nm
$F_C$	mounting force with clip		20		120	N

### Product Marking

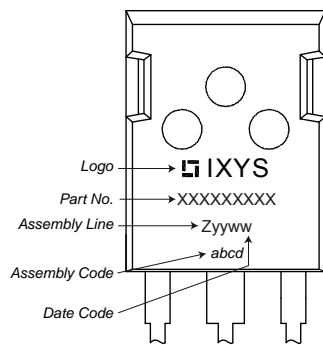

Ordering	Part Number	Marking on Product	Delivery Mode	Quantity	Code No.
Standard	DSP45-18A	DSP45-18A	Tube	30	515188

Similar Part	Package	Voltage class
DSP45-16A	TO-247AD (3)	1600
DSP45-16AZ	TO-268AA (D3Pak) (2HV)	1600
DSP45-16AR	ISOPLUS247 (3)	1600
DSP45-12A	TO-247AD (3)	1200
DSP45-12AZ	TO-268AA (D3Pak) (2HV)	1200

### Equivalent Circuits for Simulation

\* on die level

$T_{VJ} = 175\text{ °C}$

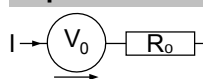

**Rectifier**

$V_{0\ max}$	threshold voltage	0.81	V
$R_{0\ max}$	slope resistance *	6.5	mΩ

**Outlines TO-247**

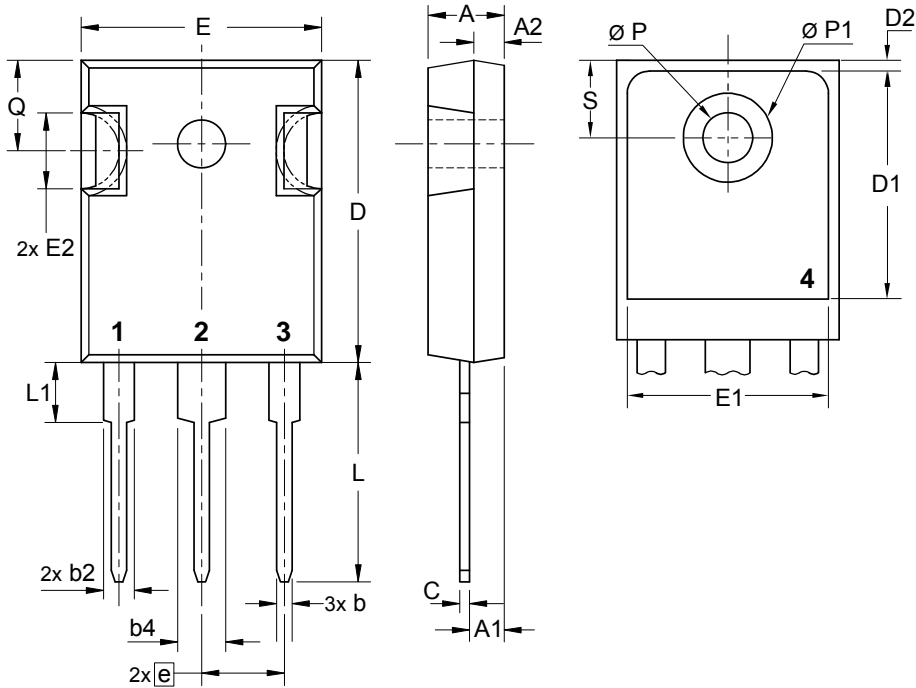

Sym.	Inches		Millimeter	
	min.	max.	min.	max.
A	0.185	0.209	4.70	5.30
A1	0.087	0.102	2.21	2.59
A2	0.059	0.098	1.50	2.49
D	0.819	0.845	20.79	21.45
E	0.610	0.640	15.48	16.24
E2	0.170	0.216	4.31	5.48
e	0.215 BSC		5.46 BSC	
L	0.780	0.800	19.80	20.30
L1	-	0.177	-	4.49
Ø P	0.140	0.144	3.55	3.65
Q	0.212	0.244	5.38	6.19
S	0.242 BSC		6.14 BSC	
b	0.039	0.055	0.99	1.40
b2	0.065	0.094	1.65	2.39
b4	0.102	0.135	2.59	3.43
c	0.015	0.035	0.38	0.89
D1	0.515	-	13.07	-
D2	0.020	0.053	0.51	1.35
E1	0.530	-	13.45	-
Ø P1	-	0.29	-	7.39

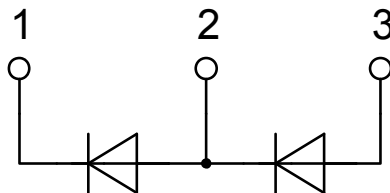

**Rectifier**

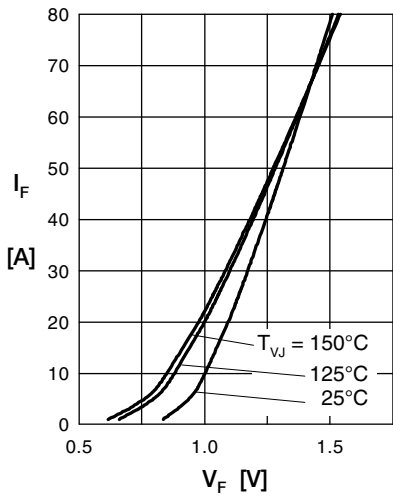

Fig. 1 Forward current versus voltage drop per diode

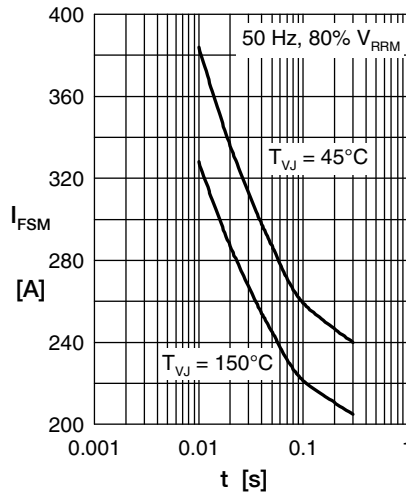

Fig. 2 Surge overload current

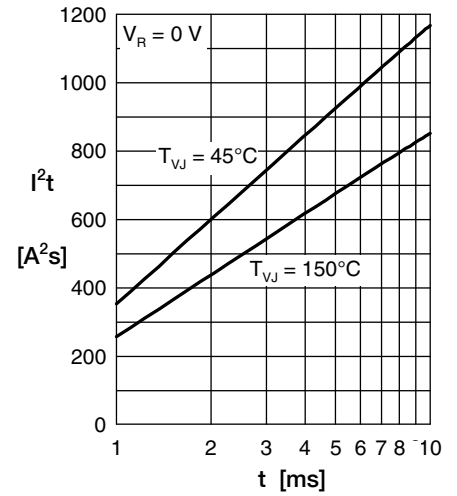

Fig. 3  $I^2t$  versus time per diode

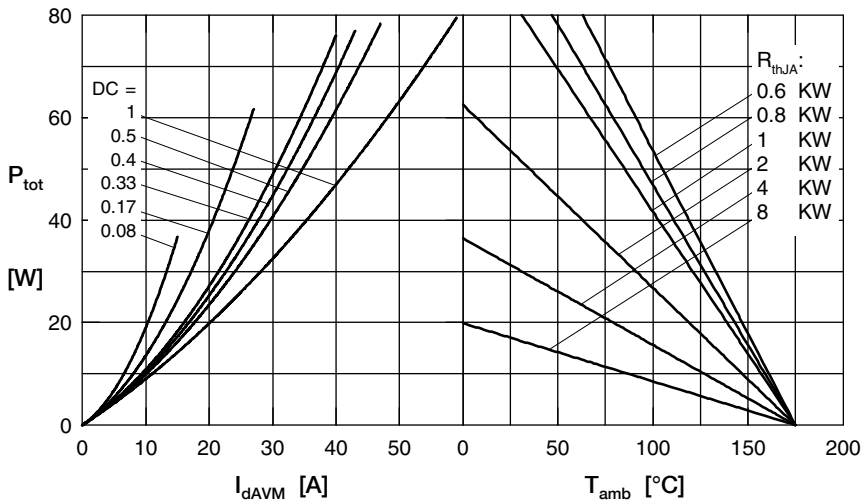

Fig. 4 Power dissipation vs. direct output current & ambient temperature

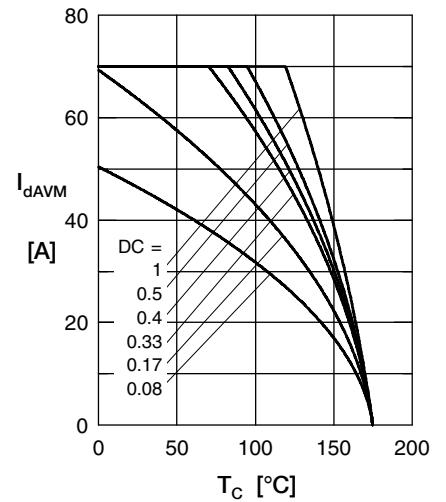

Fig. 5 Max. forward current vs. case temperature

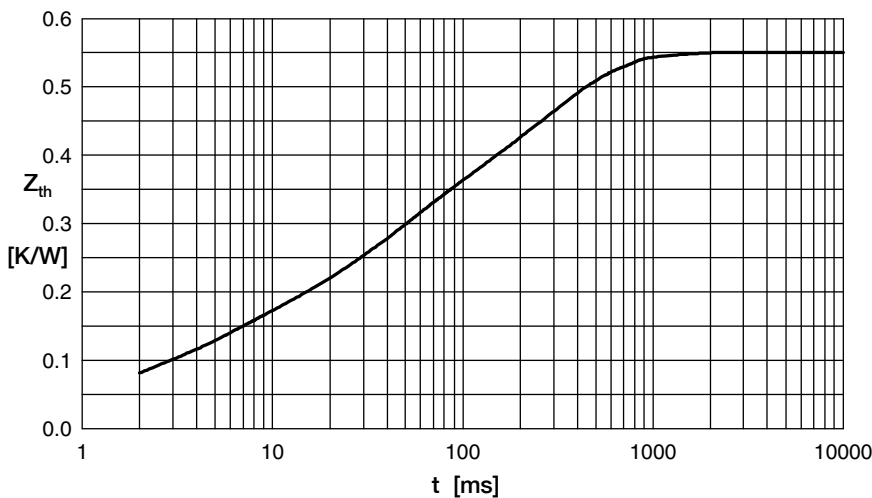

Fig. 6 Transient thermal impedance junction to case

i	$R_i$	$t_i$
1	0.033	0.0006
2	0.095	0.0039
3	0.164	0.033
4	0.258	0.272