



# 600 V IL4116 700 V IL4117 800 V IL4118

## Zero Voltage Crossing Triac Optocoupler

### FEATURES

- **High Input Sensitivity:**  $I_{FT}=1.3$  mA, PF=1.0;  $I_{FT}=3.5$  mA, Typical PF < 1.0
- **Zero Voltage Crossing**
- **600/700/800 V Blocking Voltage**
- **300 mA On-State Current**
- **High Static dv/dt 10,000 V/μsec., typical**
- **Inverse Parallel SCRs Provide Commutating dv/dt > 10 kV/msec.**
- **Very Low Leakage < 10 μA**
- **Isolation Test Voltage from Double Molded Package 5300 V<sub>RMS</sub>**
- **Package, 6-Pin DIP**
- **Underwriters Lab File #E52744**
- **VDE #0884 Available with Option 1**

### DESCRIPTION

The IL411x consists of an AlGaAs IRLED optically coupled to a photosensitive zero crossing TRIAC network. The TRIAC consists of two inverse parallel connected monolithic SCRs. These three semiconductor are assembled in a six pin 0.3 inch dual in-line package, using high insulation double molded, over/under leadframe construction.

High input sensitivity is achieved by using an emitter follower phototransistor and a cascaded SCR predriver resulting in an LED trigger current of less than 1.3 mA(DC).

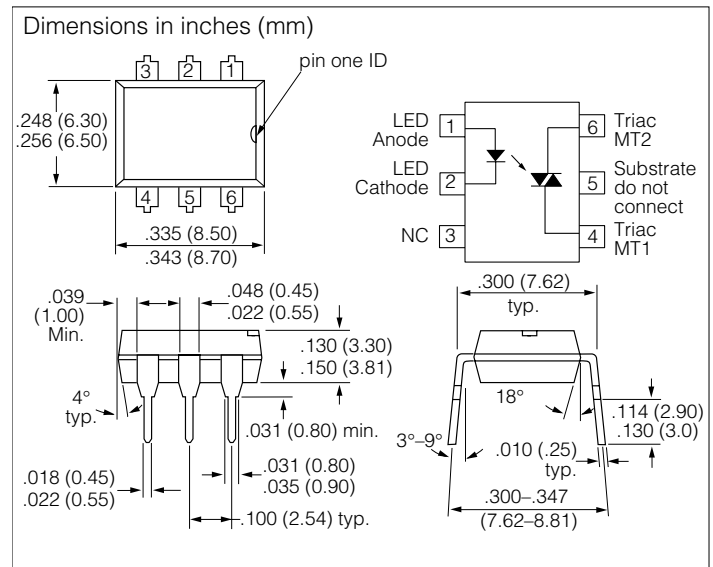
The IL411x uses two discrete SCRs resulting in a commutating dv/dt greater than 10 kV/ms. The use of a proprietary dv/dt clamp results in a static dv/dt of greater than 10 kV/μs. This clamp circuit has a MOSFET that is enhanced when high dv/dt spikes occur between MT1 and MT2 of the TRIAC. When conducting, the FET clamps the base of the phototransistor, disabling the first stage SCR predriver.

The zero cross line voltage detection circuit consists of two enhancement MOSFETS and a photodiode. The inhibit voltage of the network is determined by the enhancement voltage of the N-channel FET. The P-channel FET is enabled by a photocurrent source that permits the FET to conduct the main voltage to gate on the N-channel FET. Once the main voltage can enable the N-channel, it clamps the base of the phototransistor, disabling the first stage SCR predriver.

The blocking voltage of up to 800 V permits control of off-line voltages up to 240 VAC, with a safety factor of more than two, and is sufficient for as much as 380 VAC. Current handling capability is up to 300 mA RMS continuous at 25°C.

The IL411x isolates low-voltage logic from 120, 240, and 380 VAC lines to control resistive, inductive, or capacitive loads including motors, solenoids, high current thyristors or TRIAC and relays.

Applications include solid-state relays, industrial controls, office equipment, and consumer appliances.



### Maximum Ratings

#### Emitter

Reverse Voltage .....	6.0 V
Forward Current.....	60 mA
Surge Current .....	2.5 A
Power Dissipation.....	100 mW
Derate Linearly from 25°C .....	1.33 mW/°C
Thermal Resistance.....	750°C/W

#### Detector

Peak Off-State Voltage	
IL4116 .....	600 V
IL4117 .....	700 V
IL4118 .....	800 V
RMS On-State Current.....	300 mA
Single Cycle Surge.....	3.0 A
Total Power Dissipation .....	500 mW
Derate Linearly from 25°C .....	6.6 mW/°C
Thermal Resistance.....	150°C/W

#### Package

Lead Soldering Temperature.....	260°C/5.0 sec.
Creepage Distance .....	≥7.0 mm
Clearance .....	≥7.0 mm
Storage Temperature.....	-55°C to +150°C
Operating Temperature.....	-55°C to +100°C
Isolation Test Voltage .....	5300 V <sub>RMS</sub>
Isolation Resistance	
$V_{IO}=500$ V, $T_A=25$ °C.....	≥10 <sup>12</sup> Ω
$V_{IO}=500$ V, $T_A=100$ °C.....	≥10 <sup>11</sup> Ω

**Characteristics  $T_A=25^\circ\text{C}$** 

Parameter	Symbol	Min.	Typ.	Max.	Unit	Condition	
<b>Emitter</b>							
Forward Voltage	$V_F$	—	1.3	1.5	V	$I_F=20\text{ mA}$	
Breakdown Voltage	$V_{BR}$	6.0	30	—	V	$I_R=10\ \mu\text{A}$	
Reverse Current	$I_R$	—	0.1	10	$\mu\text{A}$	$V_R=6.0\text{ V}$	
Capacitance	$C_O$	—	40	—	pF	$V_F=0\text{ V}$ , $f=1.0\text{ MHz}$	
Thermal Resistance, Junction to Lead	$R_{THJL}$	—	750	—	K/W	—	
<b>Output Detector</b>							
Repetitive Peak Off-State Voltage	IL4116	$V_{DRM}$	600	650	—	V	$I_{DRM}=100\ \mu\text{A}$
	IL4117		700	750	—		
	IL4118		800	850	—		
Off-State Voltage	IL4116	$V_{D(RMS)}$	424	460	—	V	$I_{D(RMS)}=70\ \mu\text{A}$
	IL4117		494	536	—		
	IL4118		565	613	—		
Off-State Current	$I_{D(RMS)}$	—	10	100	$\mu\text{A}$	$V_D=600\text{ V}$ , $T_A=100^\circ\text{C}$	
On-State Voltage	$V_{TM}$	—	1.7	3.0	V	$I_T=300\text{ mA}$	
On-State Current	$I_{TM}$	—	—	300	mA	PF=1.0, $V_{T(RMS)}=1.7\text{ V}$	
Surge (Non-Repetitive, On-State Current)	$I_{TSM}$	—	—	3.0	A	$f=50\text{ Hz}$	
Holding Current	$I_H$	—	65	200	$\mu\text{A}$	$V_T=3.0\text{ V}$	
Latching Current	$I_L$	—	5.0	—	mA	$V_T=2.2\text{ V}$	
LED Trigger Current	$I_{FT}$	—	0.7	1.3	mA	$V_{AK}=5.0\text{ V}$	
Zero Cross Inhibit Voltage	$V_{IH}$	—	15	25	V	$I_F=\text{Rated } I_{FT}$	
Turn-On Time	$t_{ON}$	—	35	—	$\mu\text{s}$	$V_{RM}=V_{DM}=424\text{ VAC}$	
Turn-Off Time	$t_{OFF}$	—	50	—	$\mu\text{s}$	PF=1.0, $I_T=300\text{ mA}$	
Critical State of Rise: Off-State Voltage	$dv_{(MT)}/dt$	10,000	—	—	V/ $\mu\text{s}$	$V_{RM}$ , $V_{DM}=400\text{ VAC}$ , $T_A=25^\circ\text{C}$	
		—	2000	—		$V_{RM}$ , $V_{DM}=400\text{ VAC}$ , $T_A=80^\circ\text{C}$	
Commutating Voltage	$dv_{(COM)}/dt$	10,000	—	—	V/ $\mu\text{s}$	$V_{RM}$ , $V_{DM}=400\text{ VAC}$ , $T_A=25^\circ\text{C}$	
		—	2000	—		$V_{RM}$ , $V_{DM}=400\text{ VAC}$ , $T_A=80^\circ\text{C}$	
Commutating Current	$di/dt$	—	100	—	A/ms	$I_T=300\text{ mA}$	
Thermal Resistance, Junction to Lead	$R_{THJL}$	—	150	—	K/W	—	
<b>Package</b>							
Critical State of Rise of Coupler Input-Output Voltage	$dv_{(IO)}/dt$	10,000	—	—	V/ $\mu\text{s}$	$I_T=0\text{ A}$ , $V_{RM}=V_{DM}=424\text{ VAC}$	
Common Mode Coupling Capacitor	$C_{CM}$	—	0.01	—	pF	—	
Package Capacitance	$C_{IO}$	—	0.8	—	pF	$f=1.0\text{ MHz}$ , $V_{IO}=0\text{ V}$	

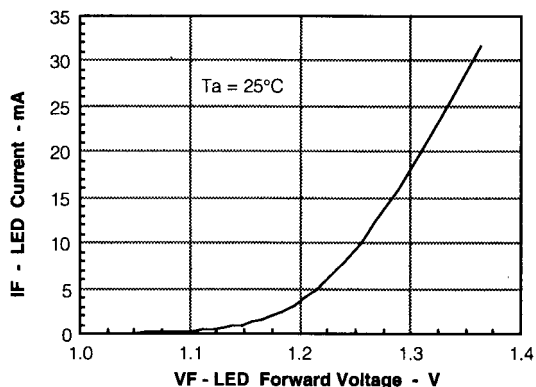
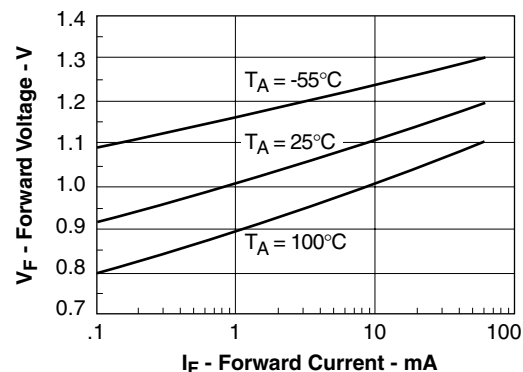
**Figure 1. LED forward current vs. forward voltage**

**Figure 2. Forward voltage versus forward current**


Figure 3. Peak LED current vs. duty factor, Tau

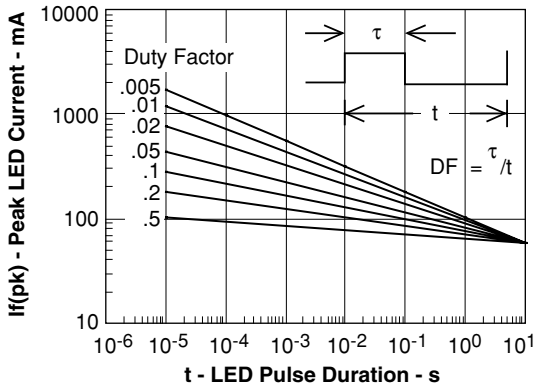


Figure 4. Maximum LED power dissipation

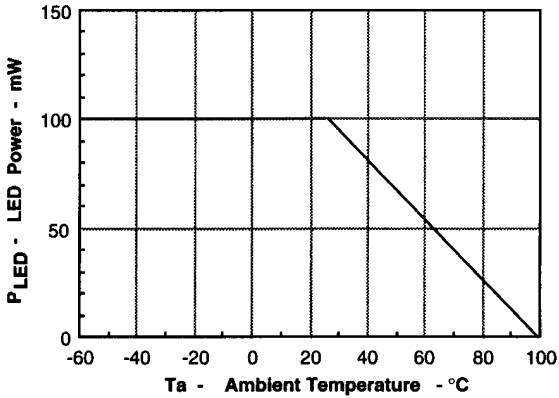


Figure 5. On-state terminal voltage vs. terminal current

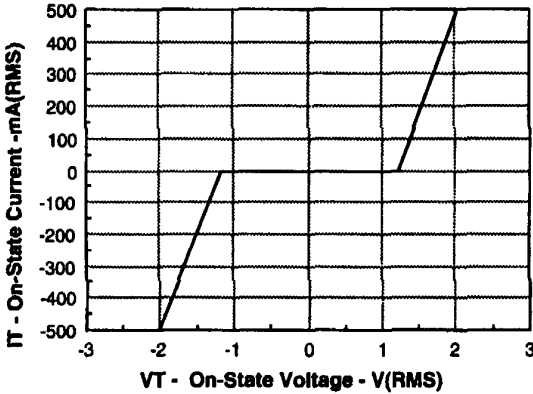
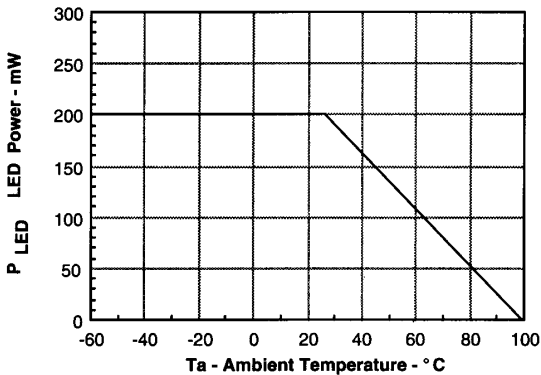


Figure 6. Maximum output power dissipation



Power Factor Considerations

A snubber isn't needed to eliminate false operation of the TRIAC driver because of the IL411's high static and commutating dv/dt with loads between 1 and 0.8 power factors. When inductive loads with power factors less than 0.8 are being driven, include a RC snubber or a single capacitor directly across the device to damp the peak commutating dv/dt spike. Normally a commutating dv/dt causes a turning-off device to stay on due to the stored energy remaining in the turning-off device.

But in the case of a zero voltage crossing optotriac, the commutating dv/dt spikes can inhibit one half of the TRIAC from turning on. If the spike potential exceeds the inhibit voltage of the zero cross detection circuit, half of the TRIAC will be held-off and not turn-on. This hold-off condition can be eliminated by using a snubber or capacitor placed directly across the optotriac as shown in Figure 7. Note that the value of the capacitor increases as a function of the load current.

The hold-off condition also can be eliminated by providing a higher level of LED drive current. The higher LED drive provides a larger photocurrent which causes the phototransistor to turn-on before the commutating spike has activated the zero cross network. Figure 8 shows the relationship of the LED drive for power factors of less than 1.0. The curve shows that if a device requires 1.5 mA for a resistive load, then 1.8 times (2.7 mA) that amount would be required to control an inductive load whose power factor is less than 0.3.

Figure 7. Shunt capacitance versus load current versus power factor

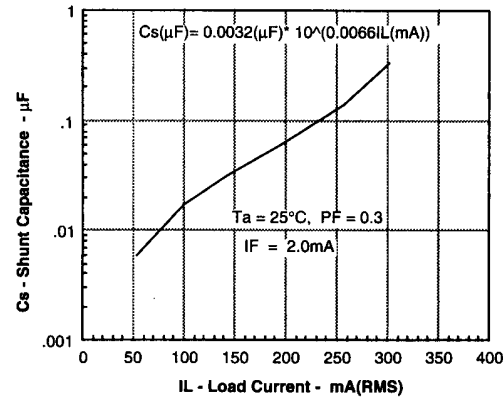


Figure 8. Normalized LED trigger current

