

**Cool MOS™ Power Transistor**
**Feature**

- New revolutionary high voltage technology
- Worldwide best  $R_{DS(on)}$  in TO 220
- Ultra low gate charge
- Periodic avalanche rated
- Extreme  $dv/dt$  rated
- High peak current capability
- Improved transconductance
- Pb-free lead plating; RoHS compliant
- Qualified according to JEDEC<sup>0)</sup> for target applications

$V_{DS}$	650	V
$R_{DS(on)}$	0.19	$\Omega$
$I_D$	20.7	A

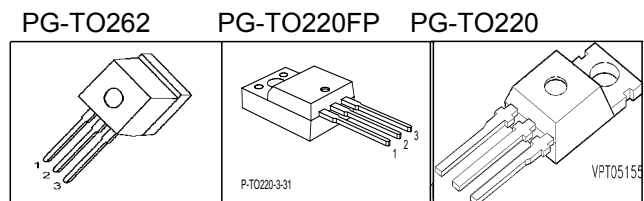

Type	Package	Ordering Code	Marking
SPP20N65C3	PG-TO220	Q67040-S4556	20N65C3
SPA20N65C3	PG-TO220FP	SP000216362	20N65C3
SPI20N65C3	PG-TO262	Q67040-S4560	20N65C3

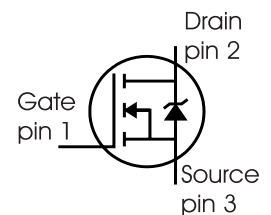
**Maximum Ratings**

Parameter	Symbol	Value		Unit
		SPP_I	SPA	
Continuous drain current $T_C = 25\text{ }^\circ\text{C}$ $T_C = 100\text{ }^\circ\text{C}$	$I_D$	20.7 13.1	20.7 <sup>1)</sup> 13.1 <sup>1)</sup>	A
Pulsed drain current, $t_p$ limited by $T_{jmax}$	$I_D$ puls	62.1	62.1	A
Avalanche energy, single pulse $I_D=3.5\text{A}$ , $V_{DD}=50\text{V}$	$E_{AS}$	690	690	mJ
Avalanche energy, repetitive $t_{AR}$ limited by $T_{jmax}$ <sup>2)</sup> $I_D=7\text{A}$ , $V_{DD}=50\text{V}$	$E_{AR}$	1	1	
Avalanche current, repetitive $t_{AR}$ limited by $T_{jmax}$	$I_{AR}$	7	7	A
Gate source voltage	$V_{GS}$	$\pm 20$	$\pm 20$	V
Gate source voltage AC ( $f > 1\text{Hz}$ )	$V_{GS}$	$\pm 30$	$\pm 30$	
Power dissipation, $T_C = 25\text{ }^\circ\text{C}$	$P_{tot}$	208	34.5	W
Operating and storage temperature	$T_j$ , $T_{stg}$	-55...+150		$^\circ\text{C}$

### Maximum Ratings

Parameter	Symbol	Value	Unit
Drain Source voltage slope $V_{DS} = 480\text{ V}$ , $I_D = 20.7\text{ A}$ , $T_j = 125\text{ °C}$	$dv/dt$	50	V/ns

### Thermal Characteristics

Parameter	Symbol	Values			Unit
		min.	typ.	max.	
Thermal resistance, junction - case	$R_{thJC}$	-	-	0.6	K/W
Thermal resistance, junction - case, FullPAK	$R_{thJC\text{ FP}}$	-	-	3.6	
Thermal resistance, junction - ambient, leaded	$R_{thJA}$	-	-	62	
Thermal resistance, junction - ambient, FullPAK	$R_{thJA\text{ FP}}$	-	-	80	
SMD version, device on PCB: @ min. footprint @ 6 cm <sup>2</sup> cooling area <sup>3)</sup>	$R_{thJA}$	-	-	62	
Soldering temperature, wavesoldering 1.6 mm (0.063 in.) from case for 10s	$T_{sold}$	-	-	260	°C

### Electrical Characteristics, at $T_j=25\text{ °C}$ unless otherwise specified

Parameter	Symbol	Conditions	Values			Unit
			min.	typ.	max.	
Drain-source breakdown voltage	$V_{(BR)DSS}$	$V_{GS}=0\text{V}$ , $I_D=0.25\text{mA}$	650	-	-	V
Drain-Source avalanche breakdown voltage	$V_{(BR)DS}$	$V_{GS}=0\text{V}$ , $I_D=7\text{A}$	-	730	-	
Gate threshold voltage	$V_{GS(th)}$	$I_D=1000\mu\text{A}$ , $V_{GS}=V_{DS}$	2.1	3	3.9	
Zero gate voltage drain current	$I_{DSS}$	$V_{DS}=600\text{V}$ , $V_{GS}=0\text{V}$ , $T_j=25\text{ °C}$ $T_j=150\text{ °C}$	-	0.1	1	$\mu\text{A}$
Gate-source leakage current	$I_{GSS}$	$V_{GS}=20\text{V}$ , $V_{DS}=0\text{V}$	-	-	100	
Drain-source on-state resistance	$R_{DS(on)}$	$V_{GS}=10\text{V}$ , $I_D=13.1\text{A}$ $T_j=25\text{ °C}$ $T_j=150\text{ °C}$	-	0.16	0.19	$\Omega$
Gate input resistance	$R_G$	$f=1\text{MHz}$ , open drain	-	0.54	-	

**Electrical Characteristics**

Parameter	Symbol	Conditions	Values			Unit
			min.	typ.	max.	
Transconductance	$g_{fs}$	$V_{DS} \geq 2 \cdot I_D \cdot R_{DS(on)max}$ $I_D = 13.1A$	-	17.5	-	S
Input capacitance	$C_{iss}$	$V_{GS} = 0V, V_{DS} = 25V,$	-	2400	-	pF
Output capacitance	$C_{oss}$	$f = 1MHz$	-	780	-	
Reverse transfer capacitance	$C_{rss}$		-	50	-	
Effective output capacitance, <sup>4)</sup> energy related	$C_{o(er)}$	$V_{GS} = 0V,$ $V_{DS} = 0V \text{ to } 480V$	-	83	-	
Effective output capacitance, <sup>5)</sup> time related	$C_{o(tr)}$		-	160	-	
Turn-on delay time	$t_{d(on)}$	$V_{DD} = 380V, V_{GS} = 0/13V,$ $I_D = 20.7A,$ $R_G = 3.6\Omega, T_j = 125$	-	10	-	ns
Rise time	$t_r$	$V_{DD} = 380V, V_{GS} = 0/13V,$	-	5	-	
Turn-off delay time	$t_{d(off)}$	$I_D = 20.7A,$	-	67	100	
Fall time	$t_f$	$R_G = 3.6\Omega$	-	4.5	12	

**Gate Charge Characteristics**

Gate to source charge	$Q_{gs}$	$V_{DD} = 480V, I_D = 20.7A$	-	11	-	nC
Gate to drain charge	$Q_{gd}$		-	33	-	
Gate charge total	$Q_g$	$V_{DD} = 480V, I_D = 20.7A,$ $V_{GS} = 0 \text{ to } 10V$	-	87	114	
Gate plateau voltage	$V_{(plateau)}$	$V_{DD} = 480V, I_D = 20.7A$	-	5.5	-	V

<sup>0</sup>J-STD20 and JESD22

<sup>1</sup>Limited only by maximum temperature

<sup>2</sup>Repetitive avalanche causes additional power losses that can be calculated as  $P_{AV} = E_{AR} \cdot f$ .

<sup>3</sup>Device on 40mm\*40mm\*1.5mm epoxy PCB FR4 with 6cm<sup>2</sup> (one layer, 70 μm thick) copper area for drain connection. PCB is vertical without blown air.

<sup>4</sup> $C_{o(er)}$  is a fixed capacitance that gives the same stored energy as  $C_{oss}$  while  $V_{DS}$  is rising from 0 to 80%  $V_{DSS}$ .

<sup>5</sup> $C_{o(tr)}$  is a fixed capacitance that gives the same charging time as  $C_{oss}$  while  $V_{DS}$  is rising from 0 to 80%  $V_{DSS}$ .

**Electrical Characteristics**

Parameter	Symbol	Conditions	Values			Unit
			min.	typ.	max.	
Inverse diode continuous forward current	$I_S$	$T_C=25^\circ\text{C}$	-	-	20.7	A
Inverse diode direct current, pulsed	$I_{SM}$		-	-	62.1	
Inverse diode forward voltage	$V_{SD}$	$V_{GS}=0\text{V}, I_F=I_S$	-	1	1.2	V
Reverse recovery time	$t_{rr}$	$V_R=480\text{V}, I_F=I_S,$	-	500	800	ns
Reverse recovery charge	$Q_{rr}$	$di_F/dt=100\text{A}/\mu\text{s}$	-	11	-	$\mu\text{C}$
Peak reverse recovery current	$I_{rrm}$		-	70	-	A
Peak rate of fall of reverse recovery current	$di_{rr}/dt$	$T_j=25^\circ\text{C}$	-	1400	-	$\text{A}/\mu\text{s}$

**Typical Transient Thermal Characteristics**

Symbol	Value		Unit	Symbol	Value		Unit
	SPP_I	SPA			SPP_I	SPA	
$R_{th1}$	0.00769	0.00769	K/W	$C_{th1}$	0.0003763	0.0003763	Ws/K
$R_{th2}$	0.015	0.015		$C_{th2}$	0.001411	0.001411	
$R_{th3}$	0.029	0.029		$C_{th3}$	0.001931	0.001931	
$R_{th4}$	0.114	0.163		$C_{th4}$	0.005297	0.005297	
$R_{th5}$	0.136	0.323		$C_{th5}$	0.012	0.008453	
$R_{th6}$	0.059	2.526		$C_{th6}$	0.091	0.412	

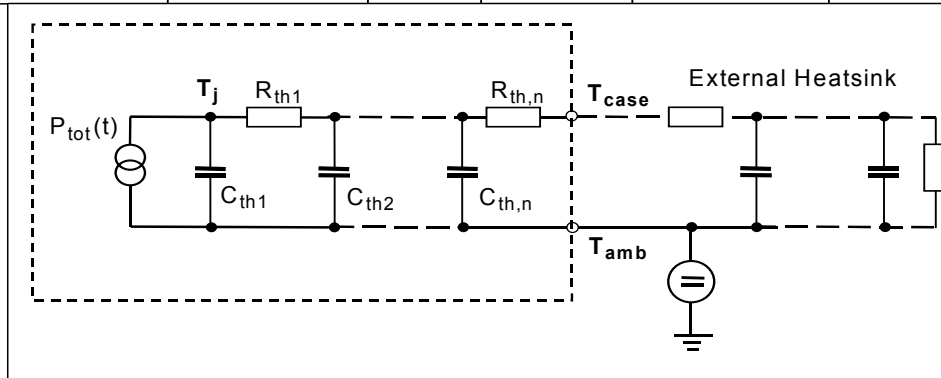

### 1 Power dissipation

$$P_{tot} = f(T_C)$$

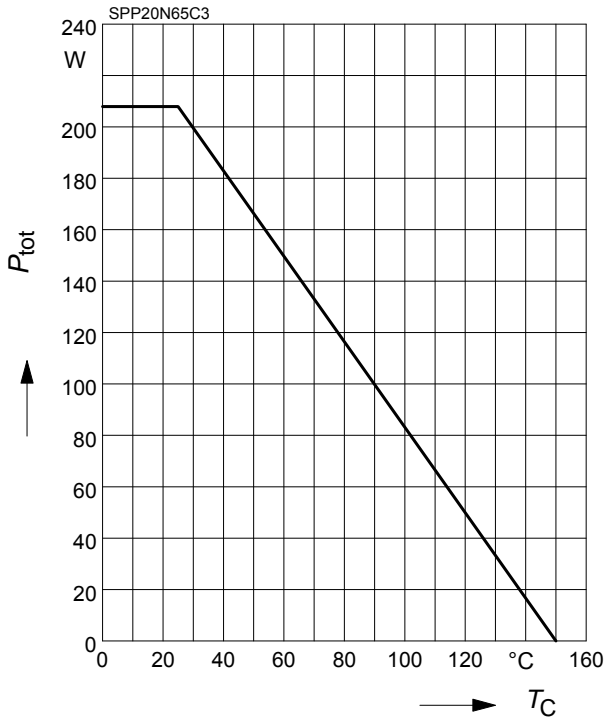

### 2 Power dissipation FullPAK

$$P_{tot} = f(T_C)$$

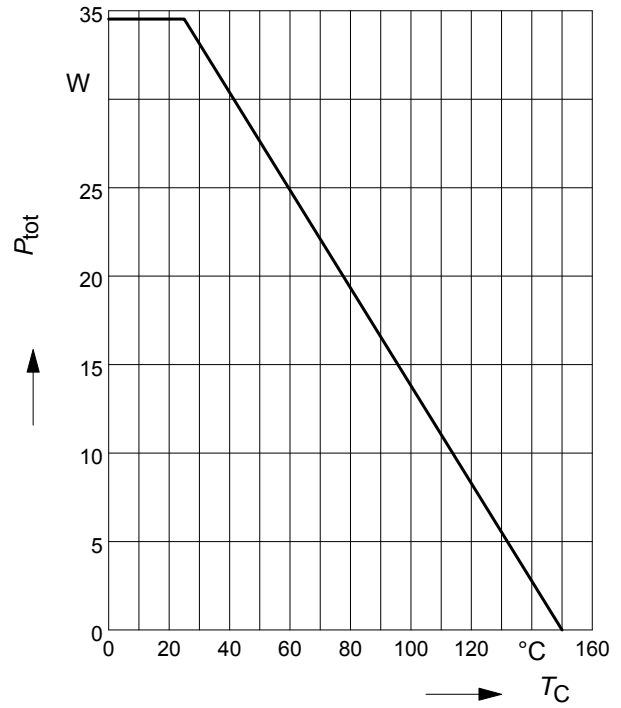

### 3 Safe operating area

$$I_D = f(V_{DS})$$

parameter :  $D = 0$  ,  $T_C = 25^\circ\text{C}$

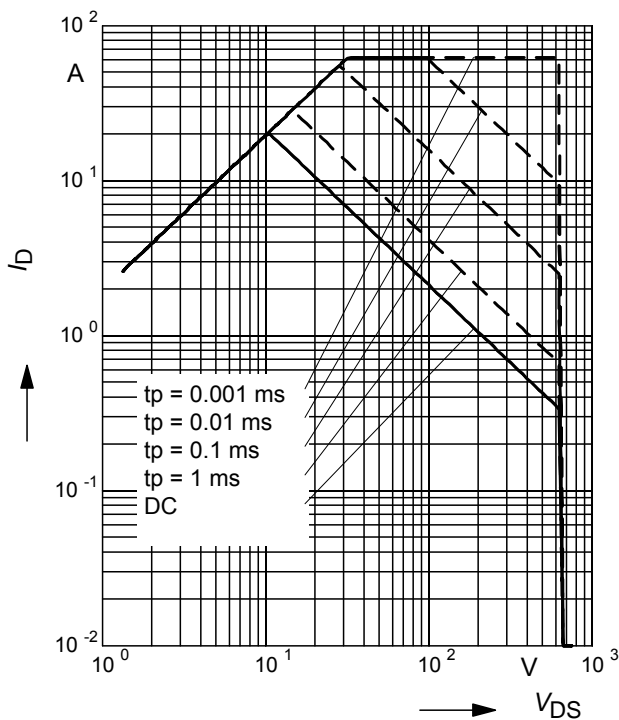

### 4 Safe operating area FullPAK

$$I_D = f(V_{DS})$$

parameter:  $D = 0$  ,  $T_C = 25^\circ\text{C}$

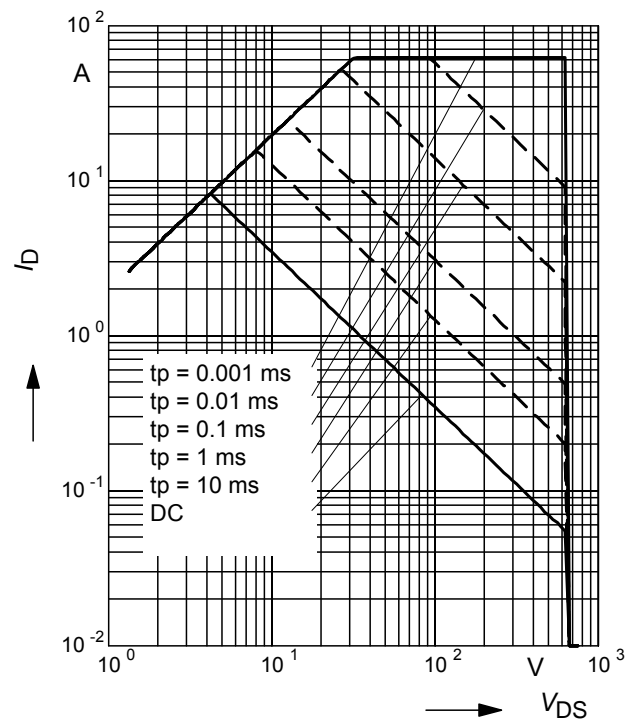

**5 Transient thermal impedance FullPAK**

$Z_{thJC} = f(t_p)$

parameter:  $D = t_p/t$

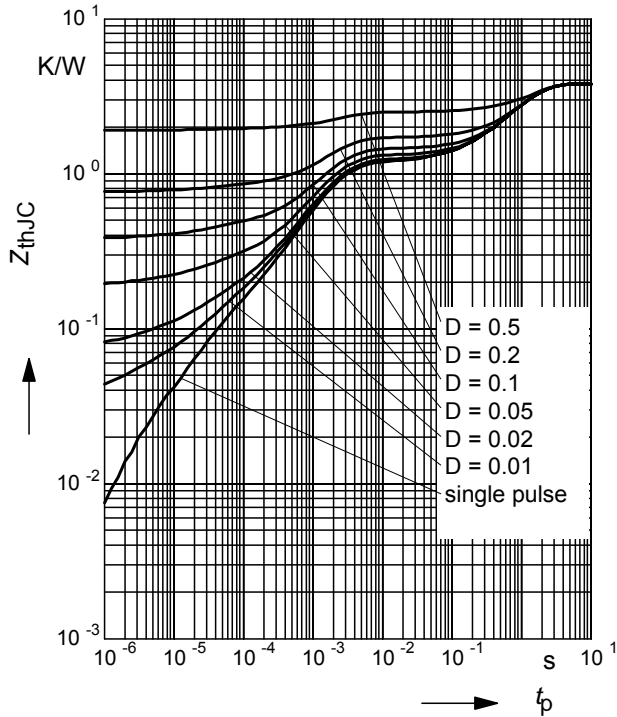

**6 Typ. output characteristic**

$I_D = f(V_{DS}); T_j=25^\circ C$

parameter:  $t_p = 10 \mu s, V_{GS}$

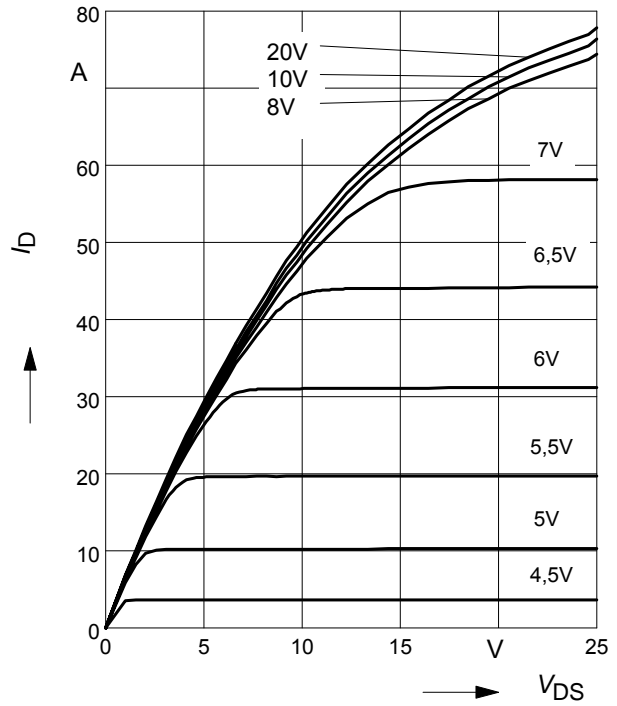

**7 Typ. output characteristic**

$I_D = f(V_{DS}); T_j=150^\circ C$

parameter:  $t_p = 10 \mu s, V_{GS}$

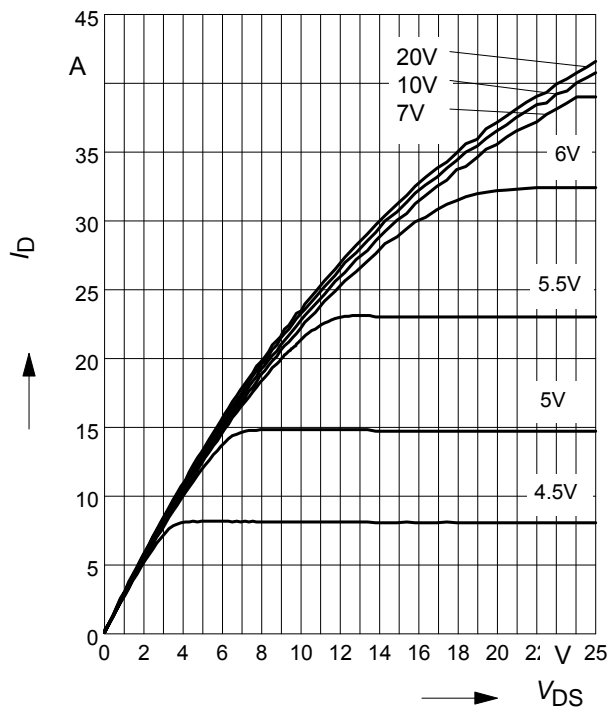

**8 Typ. drain-source on resistance**

$R_{DS(on)} = f(I_D)$

parameter:  $T_j=150^\circ C, V_{GS}$

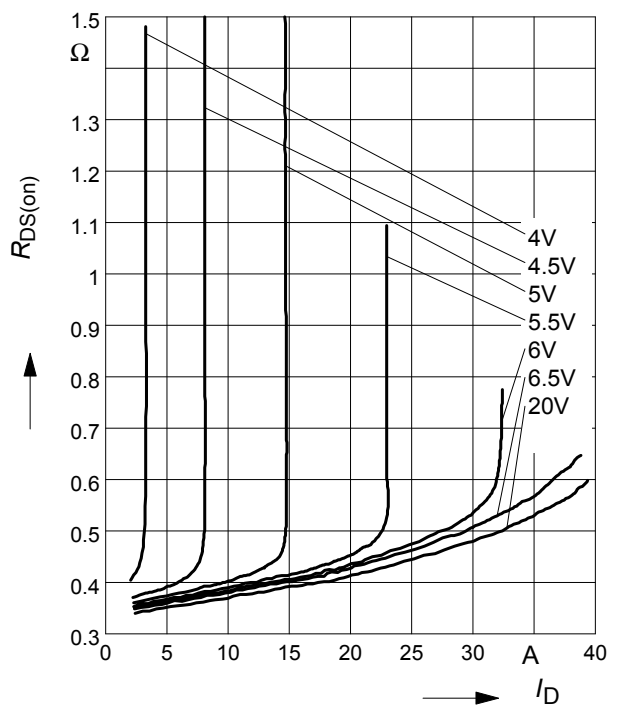

**9 Drain-source on-state resistance**

$$R_{DS(on)} = f(T_j)$$

parameter:  $I_D = 13.1 \text{ A}$ ,  $V_{GS} = 10 \text{ V}$

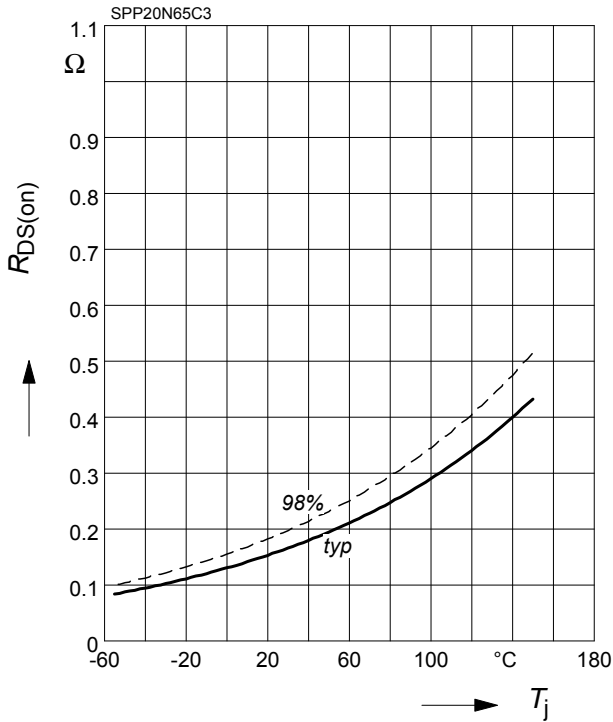

**10 Typ. transfer characteristics**

$$I_D = f(V_{GS}); V_{DS} \geq 2 \times I_D \times R_{DS(on)max}$$

parameter:  $t_p = 10 \mu\text{s}$

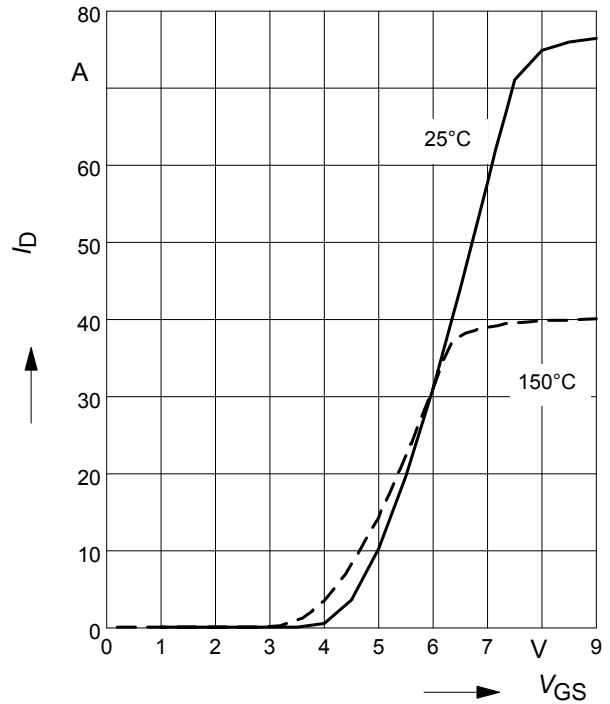

**11 Typ. gate charge**

$$V_{GS} = f(Q_{Gate})$$

parameter:  $I_D = 20.7 \text{ A}$  pulsed

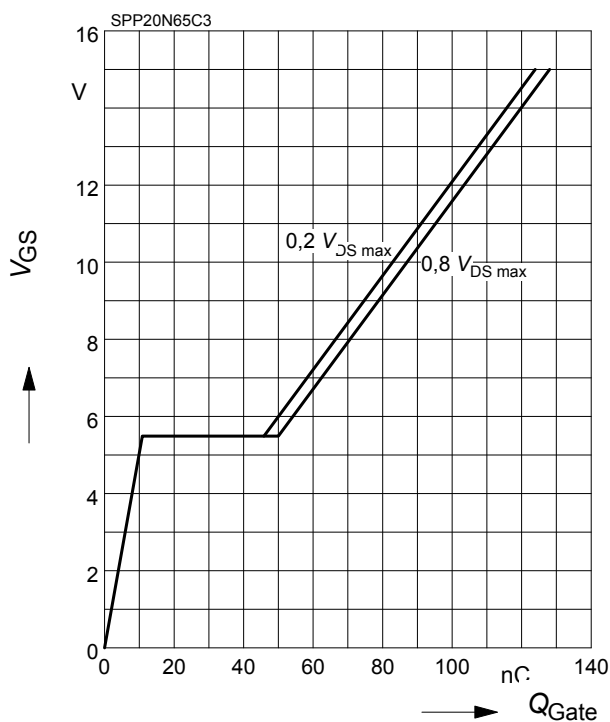

**12 Forward characteristics of body diode**

$$I_F = f(V_{SD})$$

parameter:  $T_j$ ,  $t_p = 10 \mu\text{s}$

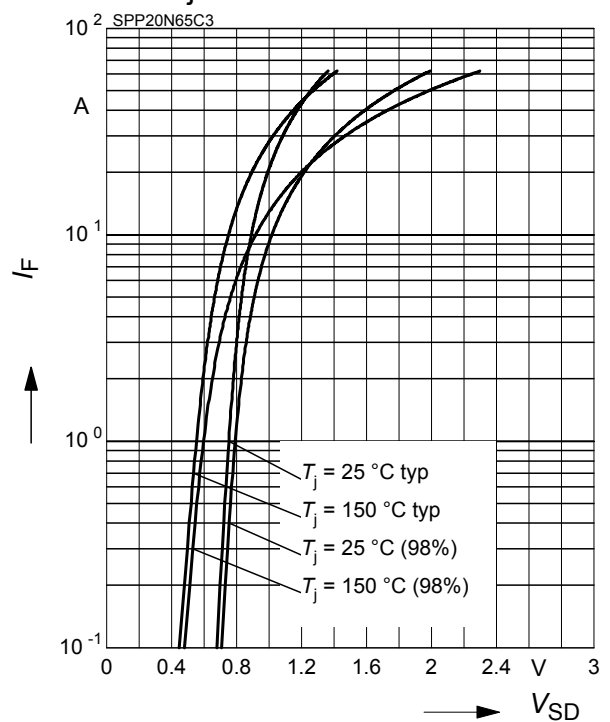

**13 Typ. switching time**

$t = f(I_D)$ , inductive load,  $T_j = 125^\circ\text{C}$   
par.:  $V_{DS} = 380\text{V}$ ,  $V_{GS} = 0/+13\text{V}$ ,  $R_G = 3.6\Omega$

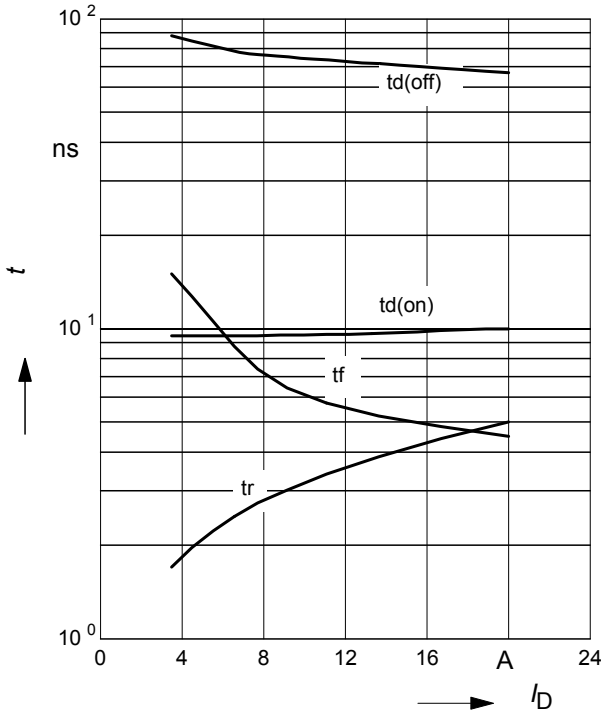

**14 Typ. switching time**

$t = f(R_G)$ , inductive load,  $T_j = 125^\circ\text{C}$   
par.:  $V_{DS} = 380\text{V}$ ,  $V_{GS} = 0/+13\text{V}$ ,  $I_D = 20.7\text{ A}$

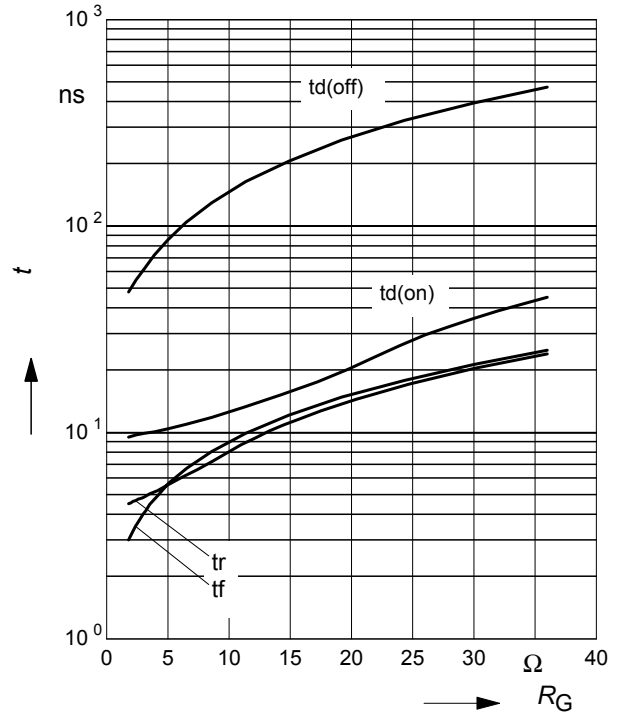

**15 Typ. drain current slope**

$di/dt = f(R_G)$ , inductive load,  $T_j = 125^\circ\text{C}$   
par.:  $V_{DS} = 380\text{V}$ ,  $V_{GS} = 0/+13\text{V}$ ,  $I_D = 20.7\text{A}$

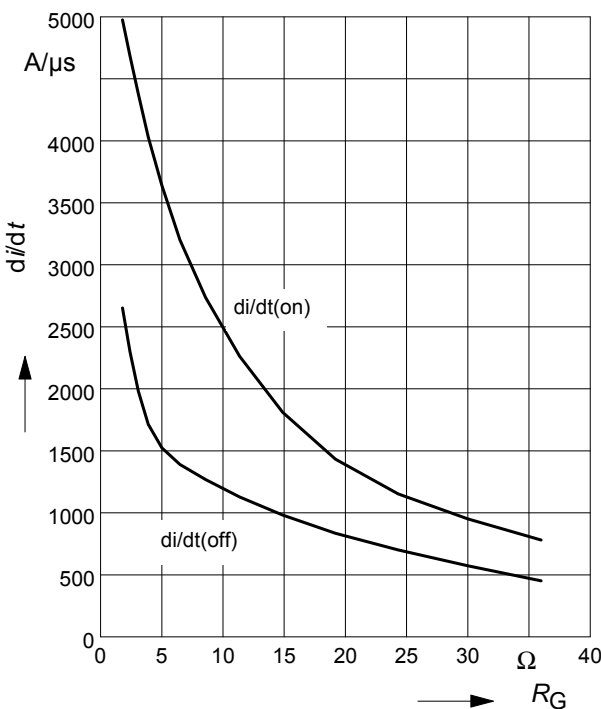

**16 Typ. drain source voltage slope**

$dv/dt = f(R_G)$ , inductive load,  $T_j = 125^\circ\text{C}$   
par.:  $V_{DS} = 380\text{V}$ ,  $V_{GS} = 0/+13\text{V}$ ,  $I_D = 20.7\text{A}$

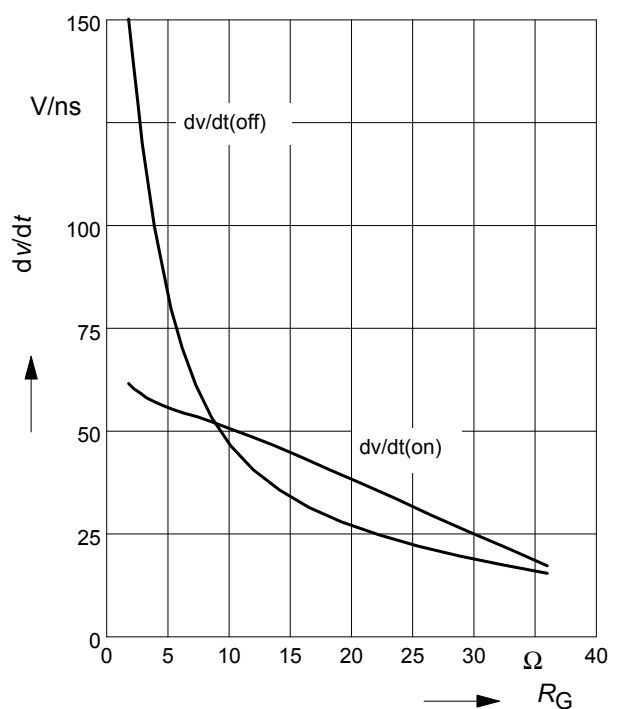



**17 Typ. switching losses**

$E = f(I_D)$ , inductive load,  $T_j=125^\circ\text{C}$   
par.:  $V_{DS}=380\text{V}$ ,  $V_{GS}=0/+13\text{V}$ ,  $R_G=3.6\Omega$

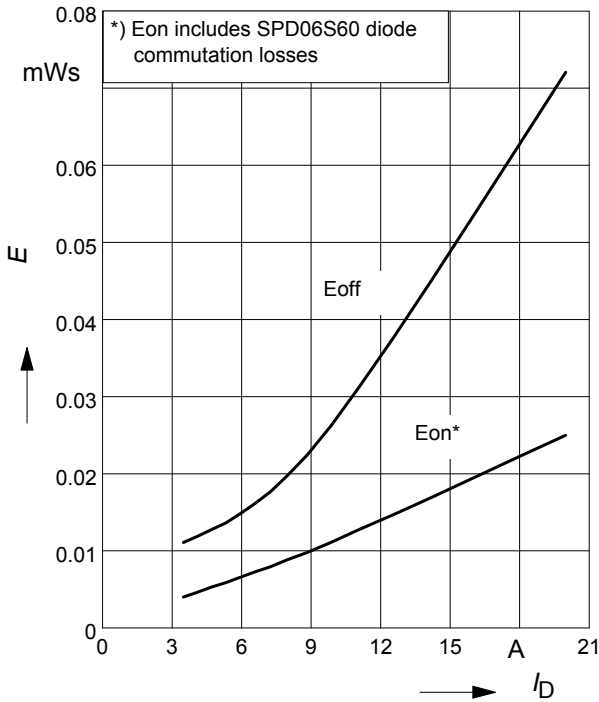

**18 Typ. switching losses**

$E = f(R_G)$ , inductive load,  $T_j=125^\circ\text{C}$   
par.:  $V_{DS}=380\text{V}$ ,  $V_{GS}=0/+13\text{V}$ ,  $I_D=11\text{A}$

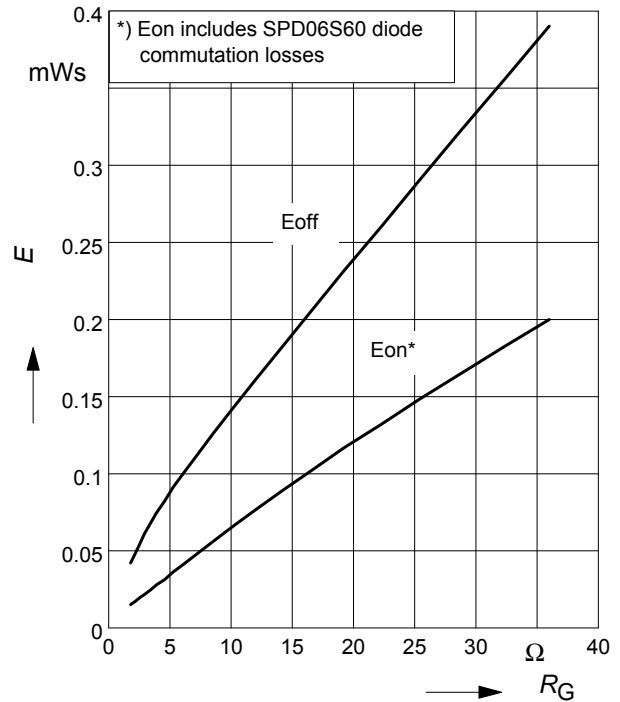

**19 Avalanche SOA**

$I_{AR} = f(t_{AR})$   
par.:  $T_j \leq 150^\circ\text{C}$

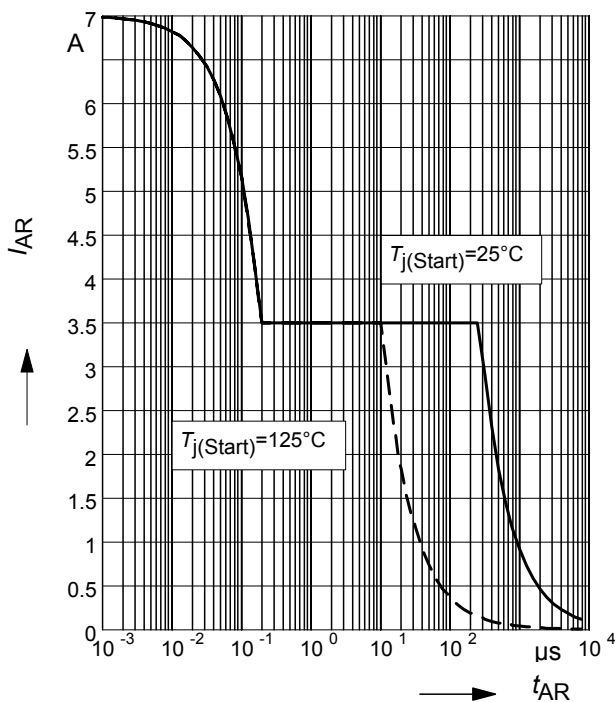

**20 Avalanche energy**

$E_{AS} = f(T_j)$   
par.:  $I_D = 3.5\text{A}$ ,  $V_{DD} = 50\text{V}$

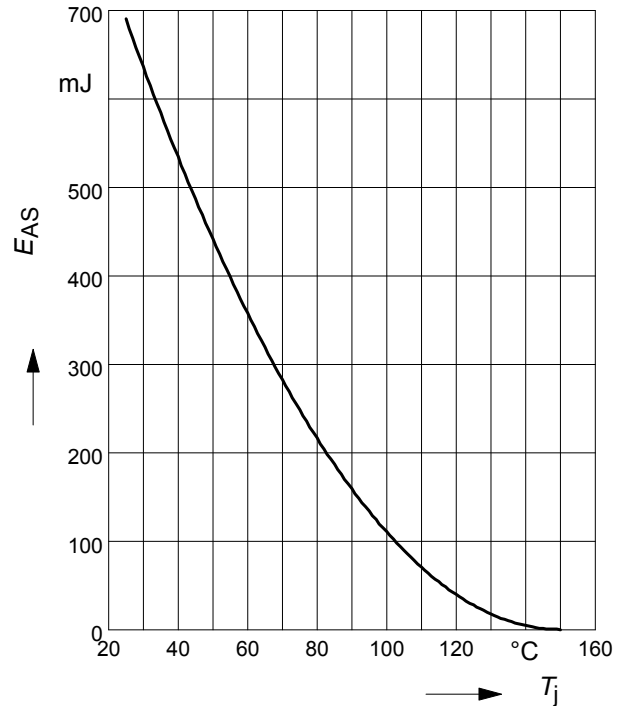

### 21 Drain-source breakdown voltage

$$V_{(BR)DSS} = f(T_j)$$

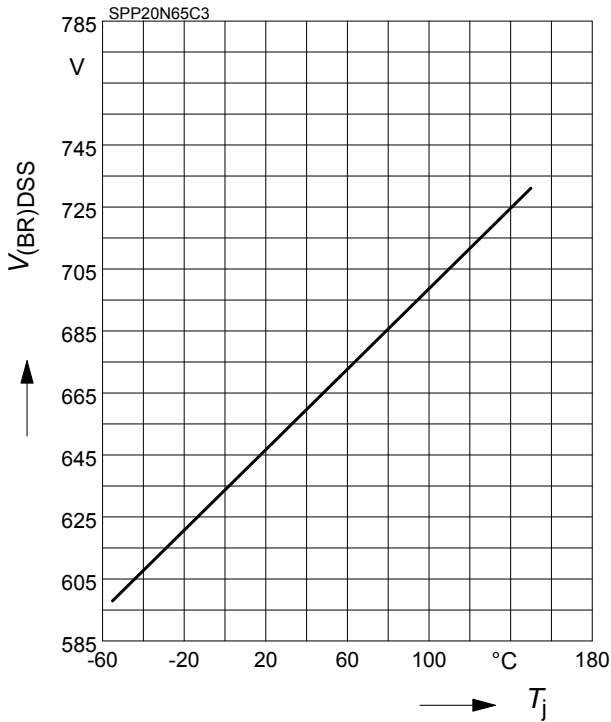

### 22 Avalanche power losses

$$P_{AR} = f(f)$$

parameter:  $E_{AR}=1\text{mJ}$

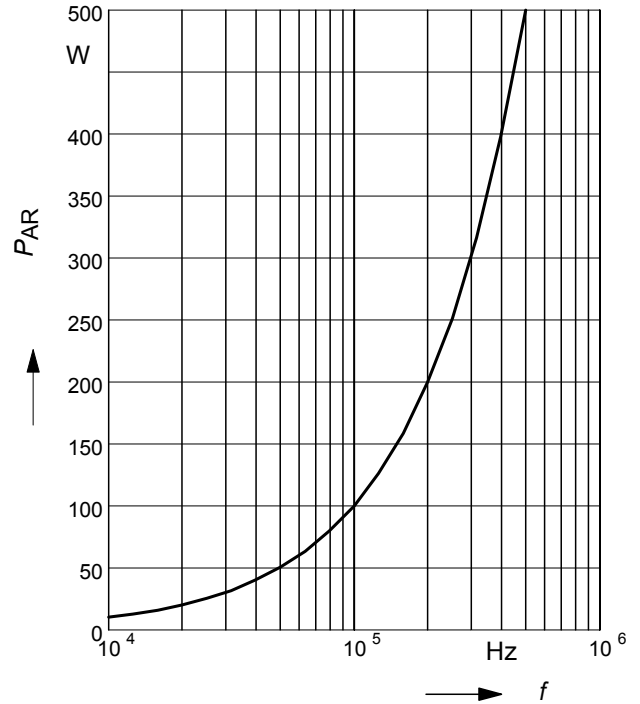

### 23 Typ. capacitances

$$C = f(V_{DS})$$

parameter:  $V_{GS}=0\text{V}$ ,  $f=1\text{ MHz}$

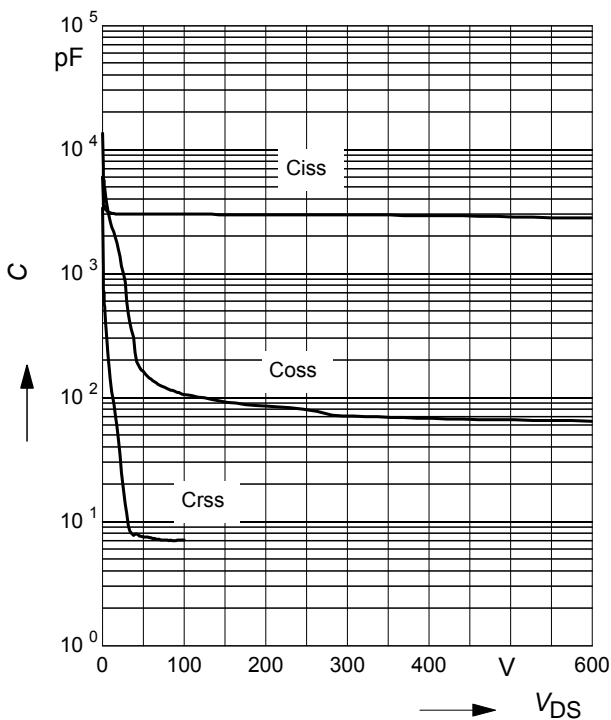

### 24 Typ. $C_{OSS}$ stored energy

$$E_{OSS} = f(V_{DS})$$

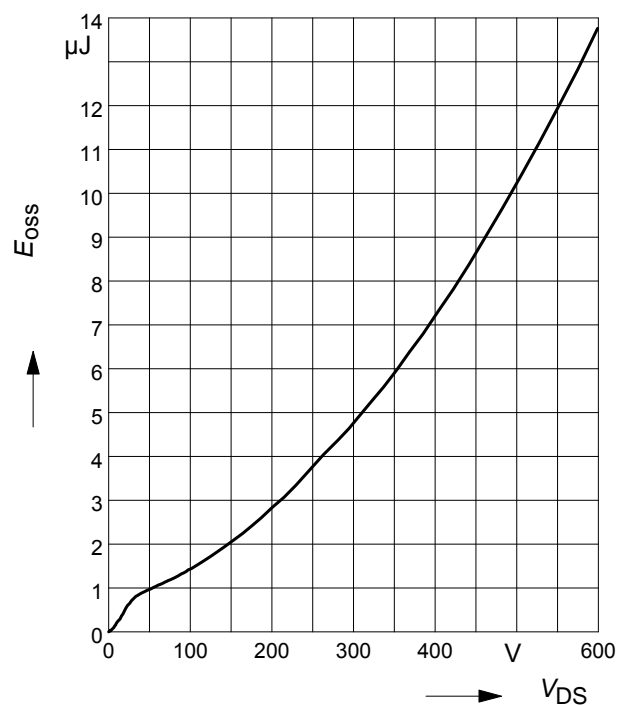

Definition of diodes switching characteristics

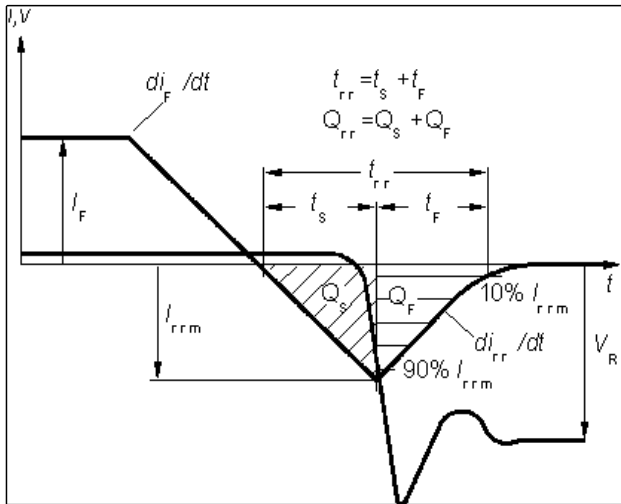

PG-TO220-3-1, PG-TO220-3-21

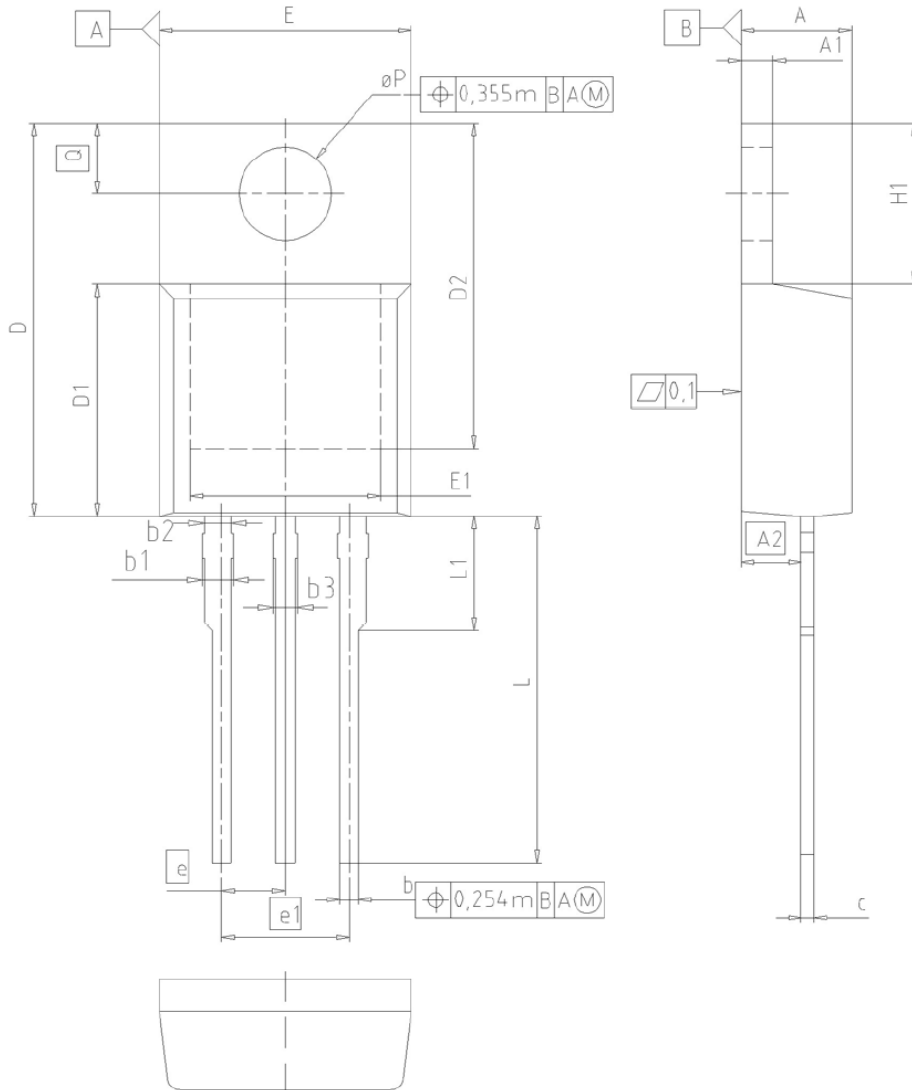

DIM	MILLIMETERS		INCHES	
	MIN	MAX	MIN	MAX
A	4.30	4.57	0.169	0.180
A1	1.17	1.40	0.046	0.055
A2	2.15	2.72	0.085	0.107
b	0.65	0.86	0.026	0.034
b1	0.95	1.40	0.037	0.055
b2	0.95	1.15	0.037	0.045
b3	0.65	1.15	0.026	0.045
c	0.33	0.60	0.013	0.024
D	14.81	15.95	0.583	0.628
D1	8.51	9.45	0.335	0.372
D2	12.19	13.10	0.480	0.516
E	9.70	10.36	0.382	0.408
E1	6.50	8.60	0.256	0.339
e	2.54		0.100	
e1	5.08		0.200	
N	3		3	
H1	5.90	6.90	0.232	0.272
L	13.00	14.00	0.512	0.551
L1	-	4.80	-	0.189
øP	3.60	3.89	0.142	0.153
Q	2.60	3.00	0.102	0.118

**DOCUMENT NO.**  
Z8B00003318

**SCALE**

**EUROPEAN PROJECTION**

**ISSUE DATE**  
23-08-2007

**REVISION**  
05

PG-TO220-3-31/3-111 Fully isolated package ( 2500 VAC; 1 minute )

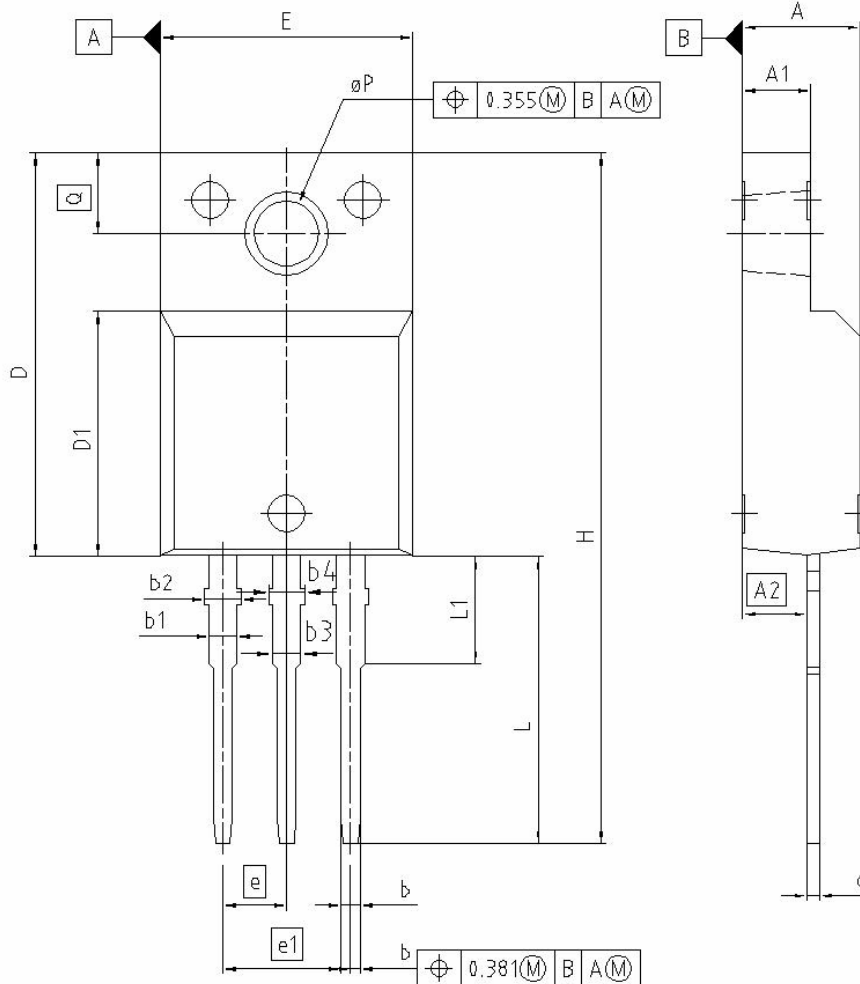

DIM	MILLIMETERS		INCHES	
	MIN	MAX	MIN	MAX
A	4.55	4.85	0.179	0.191
A1	2.55	2.85	0.100	0.112
A2	2.42	2.72	0.095	0.107
b	0.65	0.85	0.026	0.033
b1	0.95	1.33	0.037	0.052
b2	0.95	1.51	0.037	0.059
b3	0.65	1.33	0.026	0.052
b4	0.65	1.51	0.026	0.059
c	0.40	0.63	0.016	0.025
D	15.85	16.15	0.624	0.636
D1	9.53	9.83	0.375	0.387
E	10.35	10.65	0.407	0.419
e	2.54		0.100	
e1	5.08		0.200	
N	3		3	
H	29.45	29.75	1.159	1.171
L	13.45	13.75	0.530	0.541
L1	3.15	3.45	0.124	0.136
øP	2.95	3.20	0.116	0.126
Q	3.15	3.50	0.124	0.138

REFERENCE  
J..

SCALE  
0 2.5 5mm

EUROPEAN PROJECTION

ISSUE DATE  
08-01-2007

FILE  
TO220\_2

PG-TO262-3-1, PG-TO262-3-21 (I<sup>2</sup>-PAK)

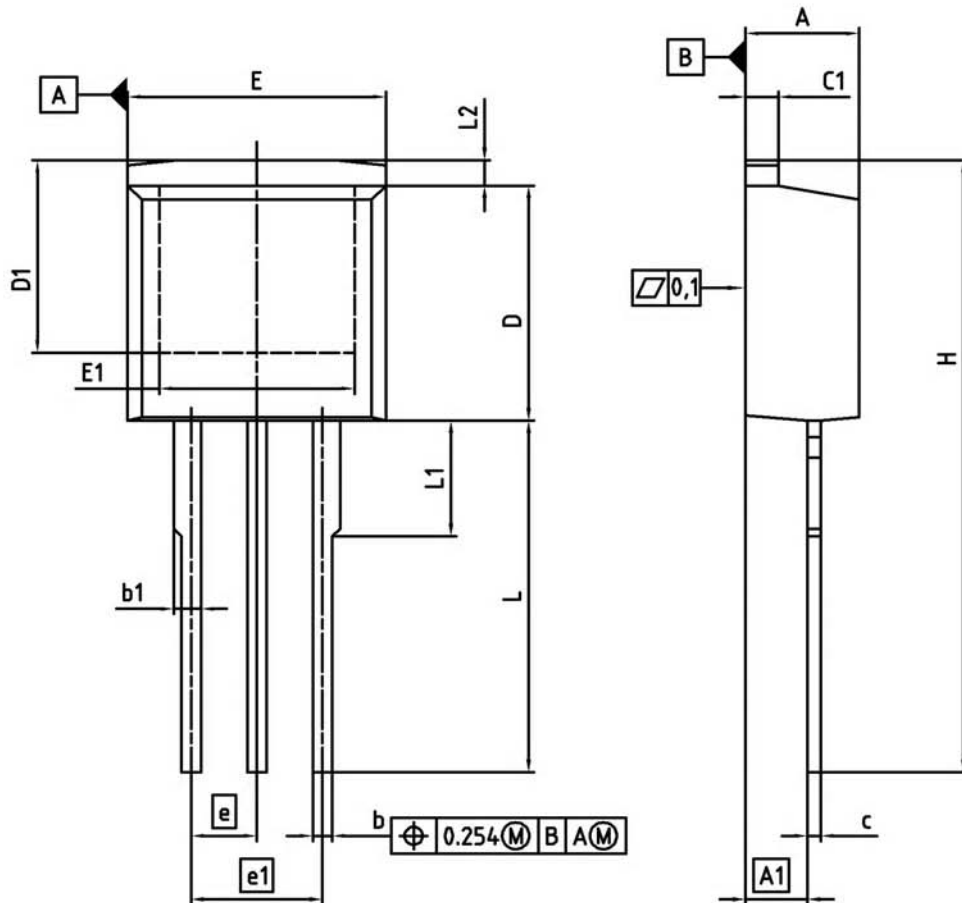

DIM	MILLIMETERS		INCHES	
	MIN	MAX	MIN	MAX
A	4.300	4.572	0.169	0.180
A1	2.150	2.718	0.085	0.107
b	0.650	0.864	0.026	0.034
b1	0.635	1.400	0.025	0.055
c	0.330	0.600	0.013	0.024
c1	1.170	1.400	0.046	0.055
D	8.509	9.450	0.335	0.372
D1	6.900	-	0.272	-
E	9.700	10.363	0.382	0.408
E1	6.500	8.600	0.256	0.339
e	2.540		0.100	
e1	5.080		0.200	
N	3		3	
L	13.000	14.000	0.512	0.551
L1	-	4.800	-	0.189
L2	-	1.727	-	0.068

REFERENCE  
JEDEC TO262

EUROPEAN PROJECTION

ISSUE DATE  
05-05-2006

FILE  
TO262\_1

**Published by  
Infineon Technologies AG  
81726 Munich, Germany  
© 2007 Infineon Technologies AG  
All Rights Reserved.**

**Legal Disclaimer**

The information given in this document shall in no event be regarded as a guarantee of conditions or characteristics. With respect to any examples or hints given herein, any typical values stated herein and/or any information regarding the application of the device, Infineon Technologies hereby disclaims any and all warranties and liabilities of any kind, including without limitation, warranties of non-infringement of intellectual property rights of any third party.

**Information**

For further information on technology, delivery terms and conditions and prices, please contact the nearest Infineon Technologies Office ([www.infineon.com](http://www.infineon.com)).

**Warnings**

Due to technical requirements, components may contain dangerous substances. For information on the types in question, please contact the nearest Infineon Technologies Office. Infineon Technologies components may be used in life-support devices or systems only with the express written approval of Infineon Technologies, if a failure of such components can reasonably be expected to cause the failure of that life-support device or system or to affect the safety or effectiveness of that device or system. Life support devices or systems are intended to be implanted in the human body or to support and/or maintain and sustain and/or protect human life. If they fail, it is reasonable to assume that the health of the user or other persons may be endangered.