



Switched Low Noise Amplifier 800 - 1000 MHz



Features

- High Gain State:
 - Gain: 16dB, Noise Figure: 1.6dB
 - Input IP₃: +3dBm (@2.7V, 25mA)
- Low Gain State:
 - Insertion Loss: 5dB, Input IP₃: +24dBm
- Single Supply: +2.7 to +5 VDC
- Low Cost MSOP-8 Plastic Package
- Adjustable current: 10 to 30 mA with external resistor

Description

M/A-COM's AM55-0016 is a high dynamic range, switchable low noise amplifier in a low cost, MSOP 8-lead, surface mount, plastic package. The design utilizes a patented switching technique to provide a low insertion loss, high input IP₃ bypass state in parallel with the high gain, low noise state. The LNA employs external input matching to obtain optimum noise figure performance and operating frequency flexibility. The AM55-0016 also features flexible biasing to control the current consumption vs. dynamic range trade-off. Its current can be controlled over a range of 10 mA to 30 mA with an external resistor.

Typical applications include receiver front ends in cellular band CDMA handsets. It is also useful as a switched gain block, buffer or driver in portable cellular systems.

The AM55-0016 is fabricated using a low-cost 0.5-micron gate length GaAs MESFET process. The process features full passivation for increased performance and reliability.

MSOP-8

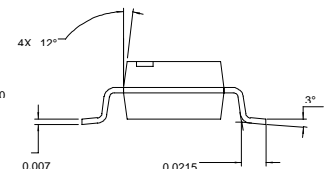
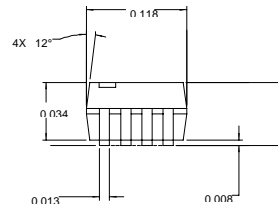
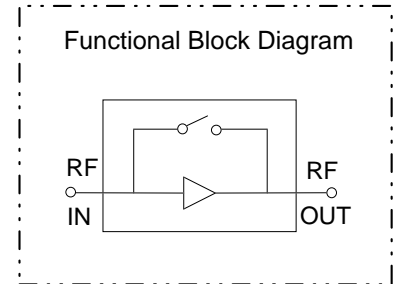
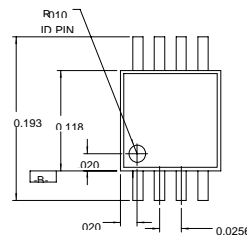

Ordering Information

Part Number	Package
AM55-0016	MSOP 8-Lead Plastic Package
AM55-0016TR	Forward Tape and Reel*
AM55-0016RTR	Reverse Tape and Reel*
AM55-0016SMB	Designer's Kit

* If specific reel size is required, consult factory for part number.

Electrical Specifications¹ T_A = +25°C, Z₀=50Ω, F=881 MHz, P_{IN}= -30 dBm, V_{DD}=2.7 V, I_{DD}=10 mA

Parameter	Test Conditions	Units	Min.	Typ.	Max.
HIGH GAIN STATE , Voltage control = 2.7 volts					
Gain		dB	—	16	—
Noise Figure		dB	—	1.6	1.8
Input IP ₃	I _{DD} = 10 mA, V _{DD} = 2.7V	dBm	—	-2	—
	I _{DD} = 25 mA, V _{DD} = 2.7V	dBm	—	+3	—
Input VSWR / Output VSWR		—	—	2.0:1	—
Reverse Isolation		dB	—	32	—
LOW GAIN STATE , Voltage control = 0 volts					
Insertion Loss	I _{DD} = 100 μA	dB	—	5	—
Input IP ₃		dBm	—	+24	—
Input VSWR		—	—	2.3:1	—
Output VSWR		—	—	2.0:1	—

1. Refer to *Typical Performance Data* for performance versus frequency and bias.



Absolute Maximum Ratings¹

Parameter	Absolute Maximum
V _{DD}	+6 VDC
Input Power	0 dBm
Current	30 mA
Channel Temperature ²	+150°C
Operating Temperature	-40°C to +85°C
Storage Temperature	-65°C to +150°C

1. Exceeding any one or combination of these limits may cause permanent damage.
2. Typical thermal resistance (θ_{jc}) = +99°C/W.

External Circuitry Parts List¹

Part	Value	Purpose
C1, C2	1000 pF	Source Bypass
C3, C4	47 pF	By-Pass
C5, C6, C7	10 nF	By-Pass
L1	22 nH	Tuning
RBIAS	see note 2	Source Bias Resistor
U1	UMH9N	Dual Bipolar Transistor

1. All external circuitry parts are readily available, low cost surface mount components (0.040 inches x 0.020 inches or 0.060 inches x 0.030 inches).
2. RBIAS is chosen to set the desired current, For:
 - $I_{dd} \sim 10$ mA, R1 = 75 ohms;
 - $I_{dd} \sim 20$ mA, R1 = 25 ohms;
 - $I_{dd} \sim 30$ mA, R1 = 9 ohms.

External Circuitry

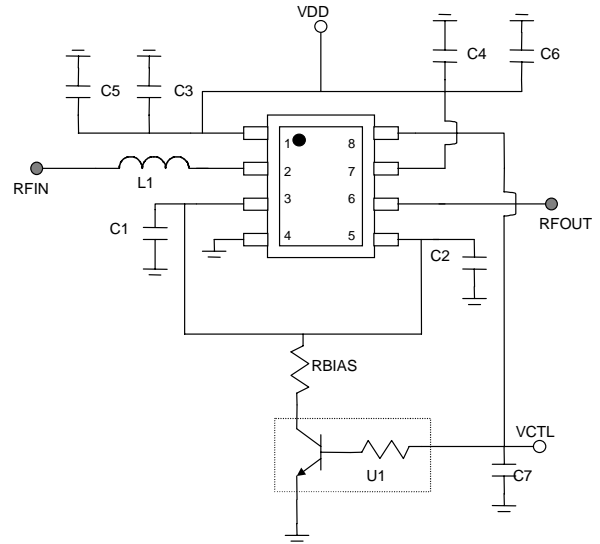

Pin Configuration

Pin No.	Pin Name	Description
1	VDD1	Stage 1 Supply Voltage
2	IN	RF Input
3	VS1	Stage 1 Source
4	GND	RF and DC Ground
5	VS2	Stage 2 Source
6	OUT	RF Output
7	VDD2	Stage 2 Supply Voltage
8	VCTL	Switch Control Voltage

Recommended PCB Configuration

Layout View

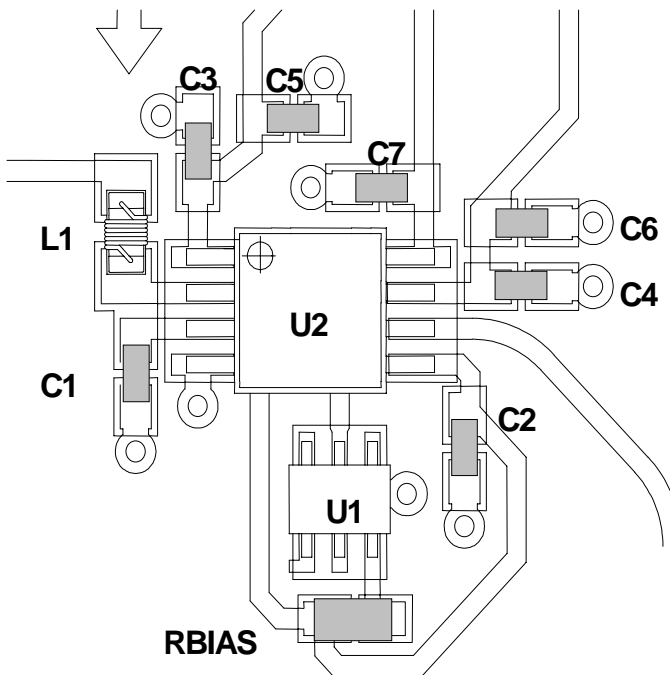

Cross Section View

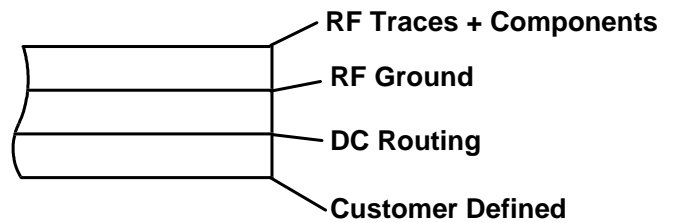

The PCB dielectric between RF traces and RF ground layers should be chosen to reduce RF discontinuities between 50 Ω lines and package pins. M/A-COM recommends an FR-4 dielectric thickness of 0.008" (0.2 mm) yielding a 50 Ω line width of 0.015" (0.38 mm). The recommended metalization thickness is 1 ounce copper.

Typical Performance Data

Test Conditions: $T_A = +25^\circ\text{C}$, $Z_0 = 50\Omega$, $V_{DD} = 2.7\text{V}$, $I_{DD} = 10\text{mA}$ unless otherwise specified.

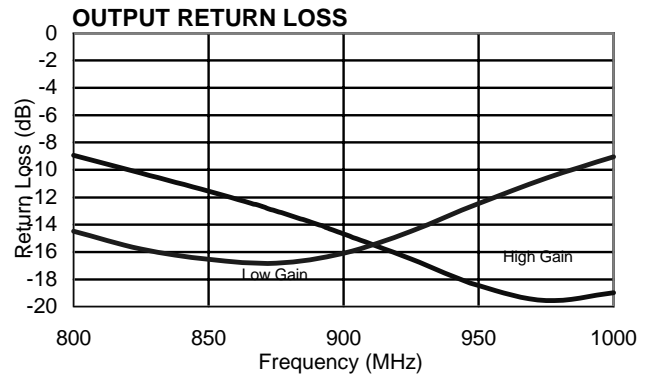
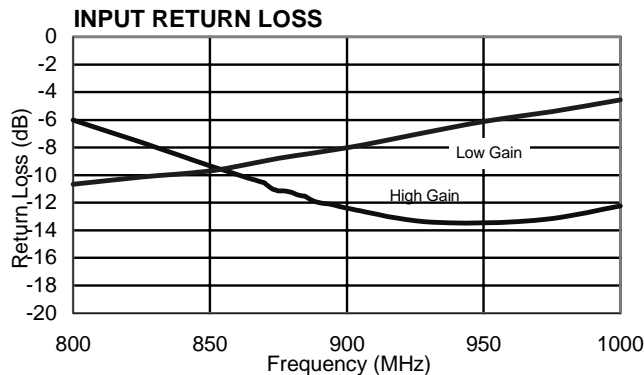
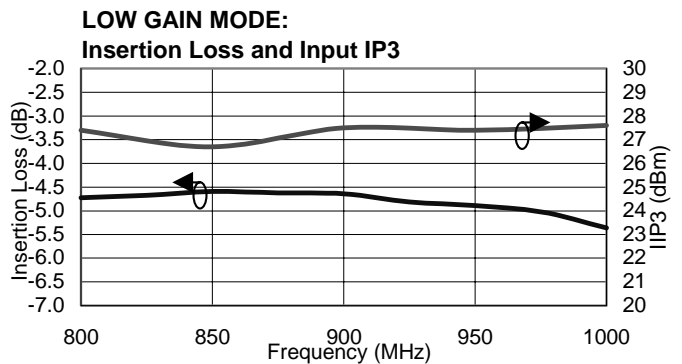
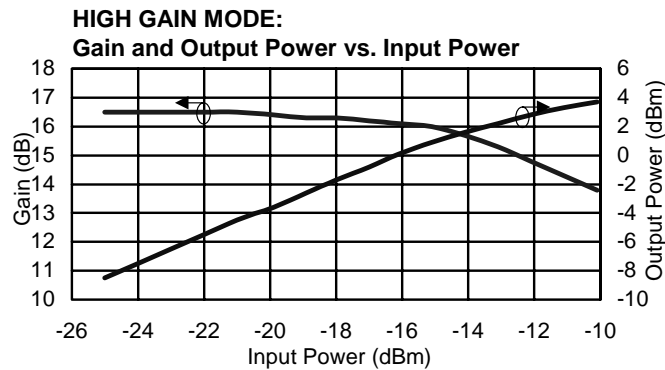
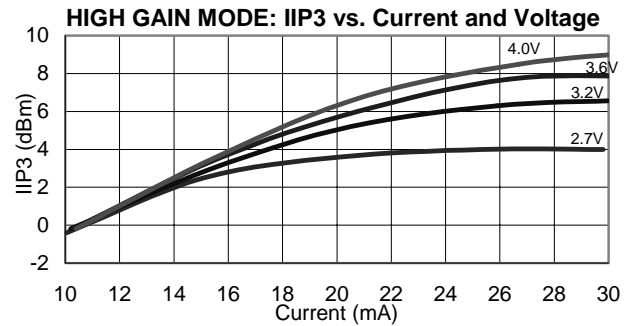
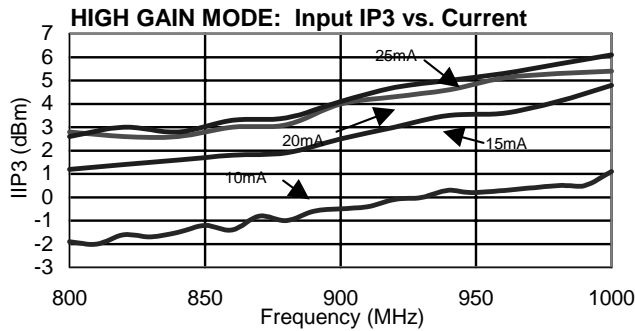
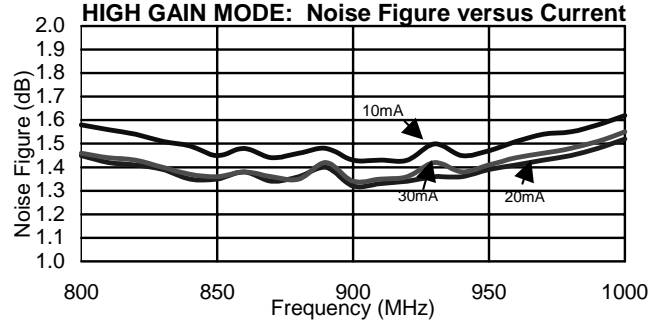
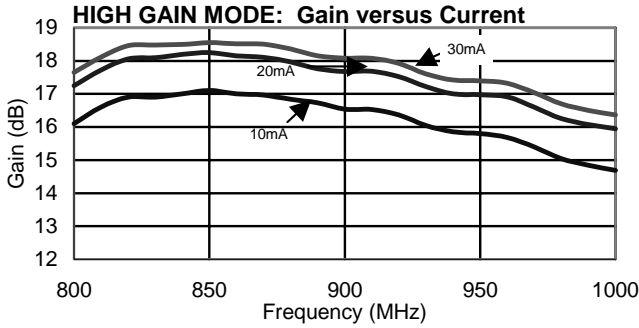

Typical Performance Data (continued)

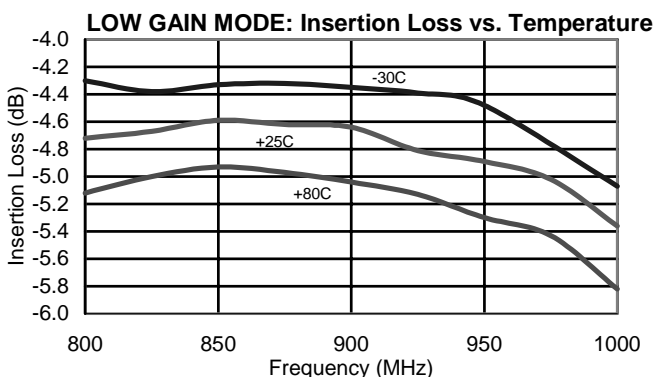
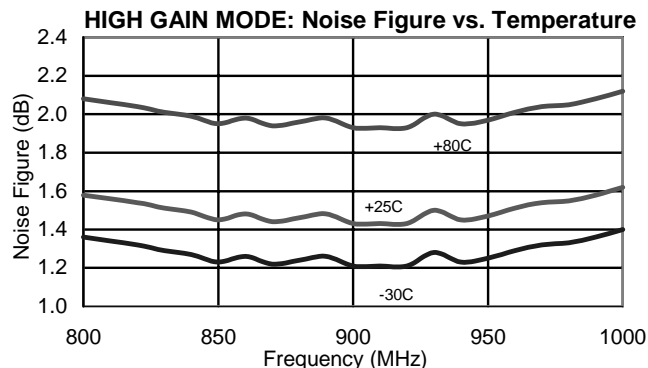
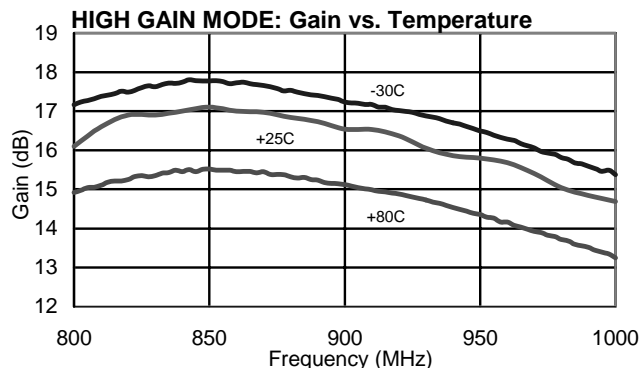

Designer's Kit AM55-0016SMB

The AM55-0016SMB Designer's Kit allows for immediate evaluation of M/A-COM's AM55-0016. The Designer's Kit includes an AM55-0016, an evaluation board and a floppy disk containing typical performance data and a DXF file of the recommended PCB layout. The evaluation board consists of the recommended external surface mount circuitry, RF connectors and a DC multi-pin connector, all mounted to a multi-layer FR-4 PCB. The AM55-0016SMB evaluation PCB is illustrated below with all functional ports labeled.

Evaluation PCB + RF Connector Losses

Port Reference	Approximate RF Loss
RF IN	0.15 dB @ 900 MHz
RF OUT	0.15 dB @ 900 MHz

The DC connector on the Designer's Kit PCB allows convenient DC line access. This is accomplished by one or more of the following methods:

1. A mating female multi-pin connector (Newark Electronics Stock # 46F-4658, not included).
2. Wires soldered to the necessary pins (not included).
3. Clip leads (not included).

AM55-0016 Evaluation Board

