



MIC861

Teeny™ Ultra Low Power Op Amp

General Description

The MIC861 is a rail-to-rail output, input common-mode to ground, operational amplifier in *Teeny™* SC70 packaging. The MIC861 provides 400kHz gain-bandwidth product while consuming an incredibly low 4.6µA supply current.

The SC70 packaging achieves significant board space savings over devices packaged in SOT-23 or MSOP-8 packaging. The SC70 occupies approximately half the board area of a SOT-23 package.

Features

- *Teeny™* SC70 packaging
- 400kHz gain-bandwidth product
- 650kHz, -3dB bandwidth
- 4.6µA supply current
- Rail-to-Rail output
- Ground sensing at input (common mode to GND)
- Drives large capacitive loads (1000pF)
- Unity gain stable

Applications

- Portable equipment
- PDAs
- Pagers
- Cordless Phones
- Consumer Electronics

Ordering Information

Part Number				Ambient Temp. Range	Package
Standard	Marking	Pb-Free	Marking*		
MIC861BC5	A33	MIC861YC5	<u>A</u> 33	-40°C to +85°C	SC-70-5

* Underbar marking may not be to scale.

Pin Configuration

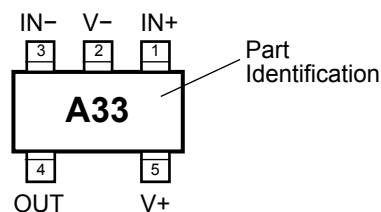

SC-70

Functional Pinout

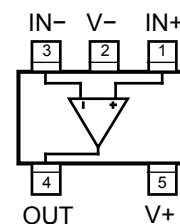

Teeny is a trademark of Micrel, Inc.

Micrel, Inc. • 2180 Fortune Drive • San Jose, CA 95131 • USA • tel + 1 (408) 944-0800 • fax + 1 (408) 474-1000 • <http://www.micrel.com>

Absolute Maximum Ratings (Note 1)

Supply Voltage ($V_{V+} - V_{-}$).....	+6.0V
Differential Input Voltage ($ V_{IN+} - V_{IN-} $), Note 4	+6.0V
Input Voltage ($V_{IN+} - V_{IN-}$)	$V_{+} + 0.3V$, $V_{-} - 0.3V$
Lead Temperature (soldering, 5 sec.).....	260°C
Output Short Circuit Current Duration	Indefinite
Storage Temperature (T_S)	150°C
ESD Rating, Note 3	

Operating Ratings (Note 2)

Supply Voltage ($V_{+} - V_{-}$)	+2.43V to +5.25V
Ambient Temperature Range.....	-40°C to +85°C
Package Thermal Resistance.....	450°C/W

Electrical Characteristics

$V_{+} = +2.7V$, $V_{-} = 0V$, $V_{CM} = V_{+}/2$; $R_L = 500k\Omega$ to $V_{+}/2$; $T_A = 25^{\circ}C$, unless otherwise noted. **Bold** values indicate $-40^{\circ}C \leq T_A \leq +85^{\circ}C$.

Symbol	Parameter	Condition	Min	Typ	Max	Units
V_{OS}	Input Offset Voltage	Note 5	-10	2	10	mV
	Input Offset Voltage Temp Coefficient			15		$\mu V/^{\circ}C$
I_B	Input Bias Current			20		pA
I_{OS}	Input Offset Current			10		pA
V_{CM}	Input Voltage Range	CMRR > 60dB		1.8		V
CMRR	Common-Mode Rejection Ratio	$0 < V_{CM} < 1.35V$	45	77		dB
PSRR	Power Supply Rejection Ratio	Supply voltage change of 3V	50	83		dB
A_{VOL}	Large-Signal Voltage Gain	$R_L = 100k$, V_{OUT} 2V peak to peak	60	74		dB
		$R_L = 500k$, V_{OUT} 2V peak to peak	73	83		dB
V_{OUT}	Maximum Output Voltage Swing	$R_L = 500k$	V+-2mV	V+-0.7mV		V
V_{OUT}	Minimum Output Voltage Swing	$R_L = 500k$		V+-0.2mV	V+-2mV	V
GBW	Gain-Bandwidth Product	$R_L = 200k\Omega$, $C_L = 2pF$, $V_{OUT} = 0$		350		kHz
BW	-3dB Bandwidth	$A_V = 1$, $C_L = 2pF$, $R_L = 1M\Omega$		500		kHz
SR	Slew Rate	$A_V = 1$, $C_L = 2pF$, $R_L = 1M\Omega$		0.12		V/ μs
I_{SC}	Short-Circuit Output Current	Source		6		mA
		Sink		5		mA
I_S	Supply Current	No Load		4.2	9	μA

$V_{+} = +5V$, $V_{-} = 0V$, $V_{CM} = V_{+}/2$; $R_L = 500k\Omega$ to $V_{+}/2$; $T_A = 25^{\circ}C$, unless otherwise noted. **Bold** values indicate $-40^{\circ}C \leq T_A \leq +85^{\circ}C$.

Symbol	Parameter	Condition	Min	Typ	Max	Units
V_{OS}	Input Offset Voltage	Note 5	-10	2	10	mV
	Input Offset Voltage Temp Coefficient			15		$\mu V/^{\circ}C$
I_B	Input Bias Current			20		pA
I_{OS}	Input Offset Current			10		pA
V_{CM}	Input Voltage Range	CMRR > 60dB		4.2		V
CMRR	Common-Mode Rejection Ratio	$0 < V_{CM} < 3.5V$	60	80		dB
PSRR	Power Supply Rejection Ratio	Supply voltage change of 1V	45	85		dB
A_{VOL}	Large-Signal Voltage Gain	$R_L = 100k$, V_{OUT} 4.0V peak to peak	60	76		dB
		$R_L = 500k$, V_{OUT} 4.0V peak to peak	68	83		dB
V_{OUT}	Maximum Output Voltage Swing	$R_L = 500k$	V+-2mV	V+-0.7mV		V
V_{OUT}	Minimum Output Voltage Swing	$R_L = 500k$		V+-0.7mV	V+-2mV	V
GBW	Gain-Bandwidth Product	$R_L = 200k\Omega$, $C_L = 2pF$, $V_{OUT} = 0$		400		kHz
BW	-3dB Bandwidth	$A_V = 1$, $C_L = 2pF$, $R_L = 1M\Omega$		650		kHz

Symbol	Parameter	Condition	Min	Typ	Max	Units
SR	Slew Rate	$A_V = 1, C_L = 2\text{pF}, R_L = 1\text{M}\Omega$		0.12		V/ μs
I_{SC}	Short-Circuit Output Current	Source	10	24		mA
		Sink	10	24		mA
I_S	Supply Current	No Load		4.6	9	μA

Note 1. Exceeding the absolute maximum rating may damage the device.

Note 2. The device is not guaranteed to function outside its operating rating.

Note 3. Devices are ESD sensitive. Handling precautions recommended. Human body model, 1.5k in series with 100pF. Pin 4 is ESD sensitive

Note 4. Exceeding the maximum differential input voltage will damage the input stage and degrade performance (in particular, input bias current is likely to increase).

Note 5. The offset voltage distribution is centered around 0V. The typical offset number shown, is equal to the standard deviation of the voltage offset distribution.

Test Circuits

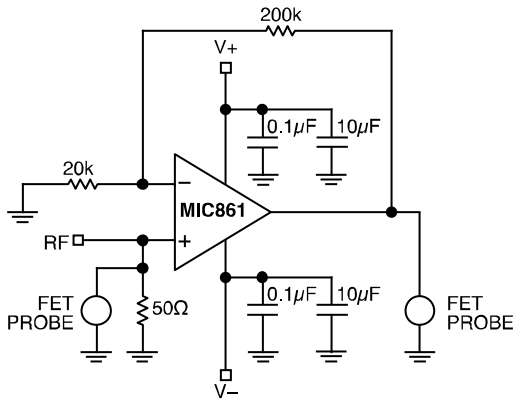

Test Circuit 1. $A_V = 11$

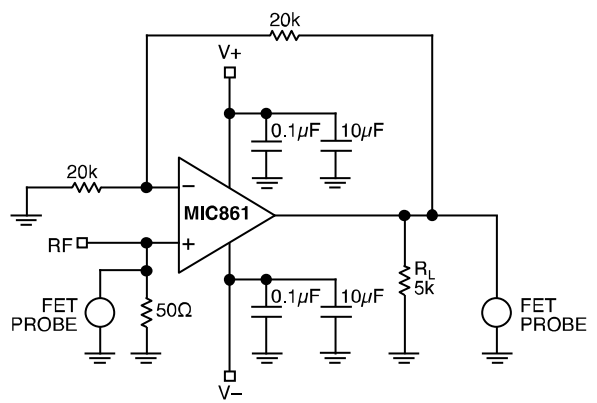

Test Circuit 2: $A_V = 2$

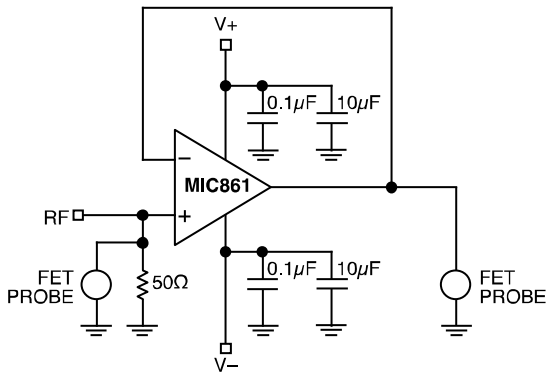

Test Circuit 3. $A_V = 1$

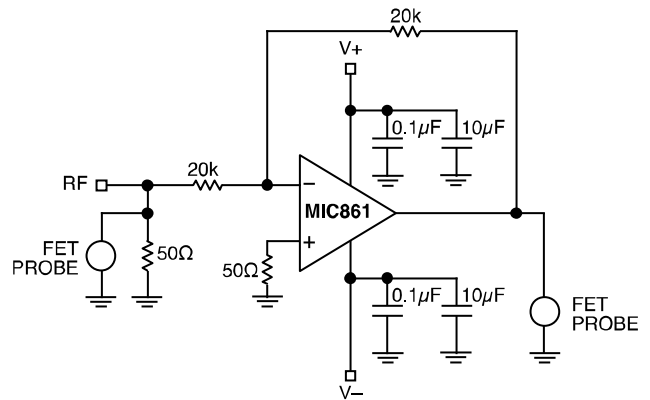

Test Circuit 4. $A_V = -1$

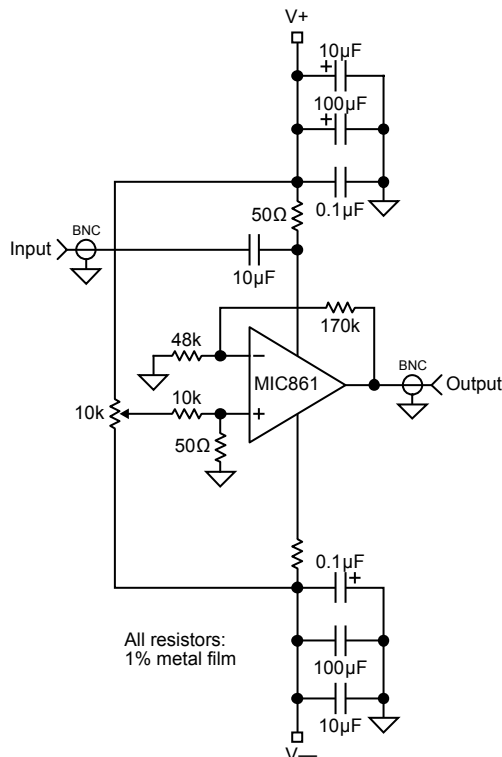

Test Circuit 5. Positive Power Supply Rejection Ratio Measurement

DC Performance Characteristics

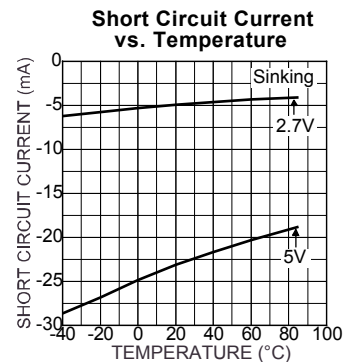
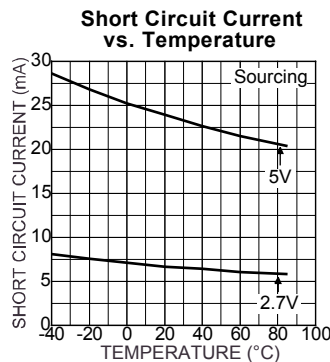
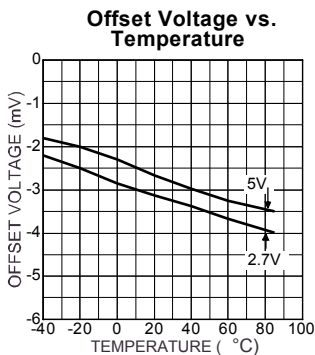
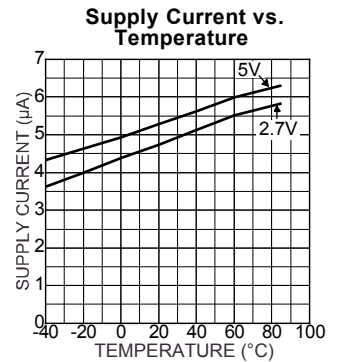
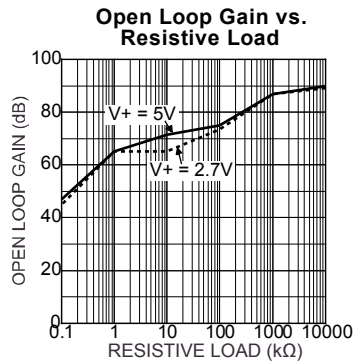
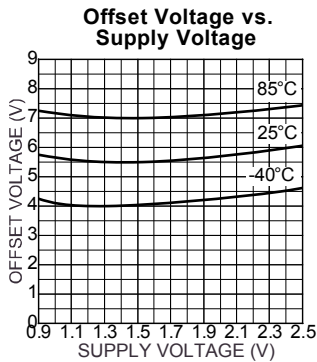
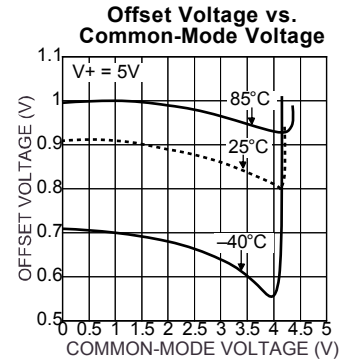
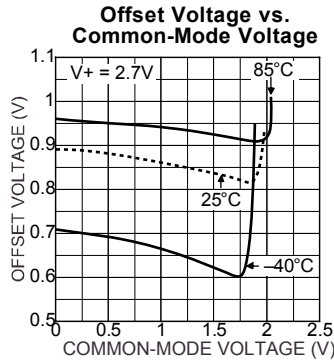
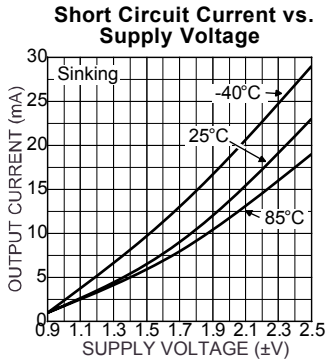
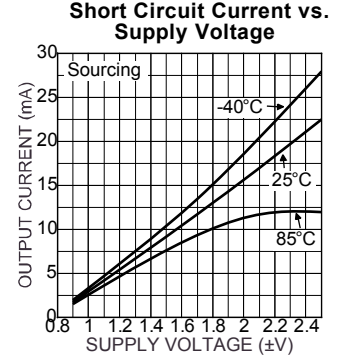
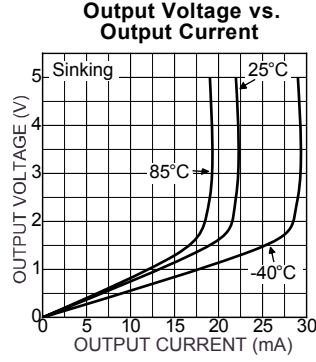
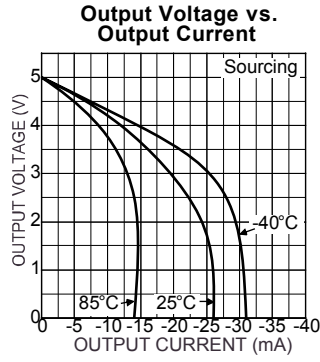

AC Performance Characteristics

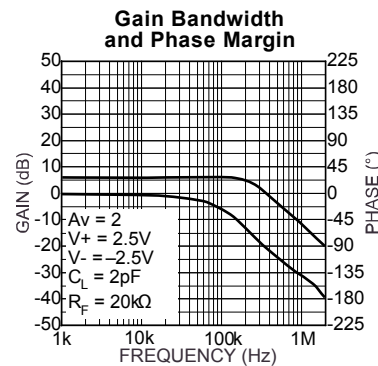
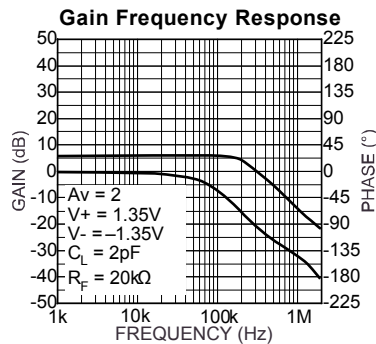
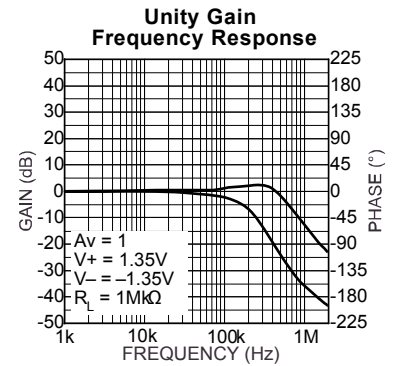
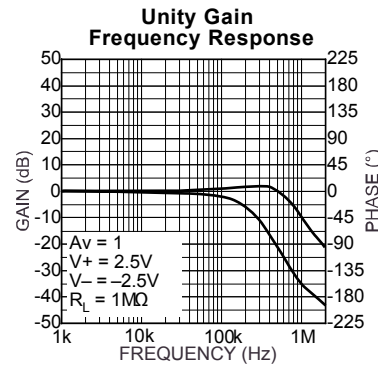
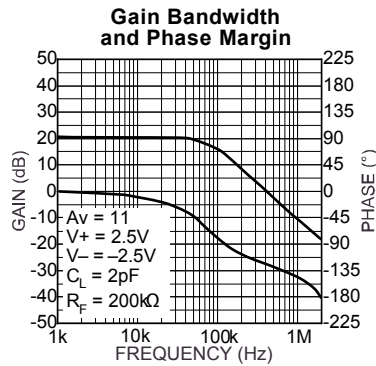
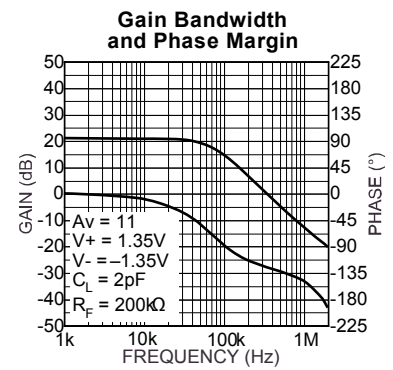
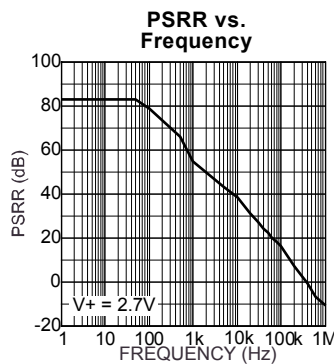
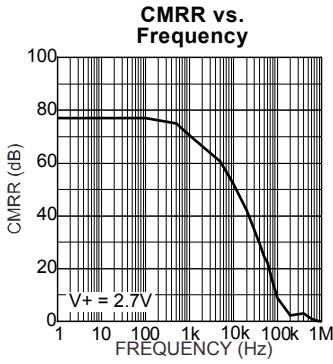
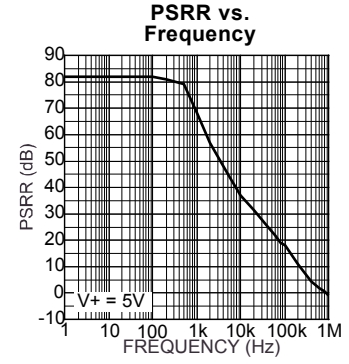
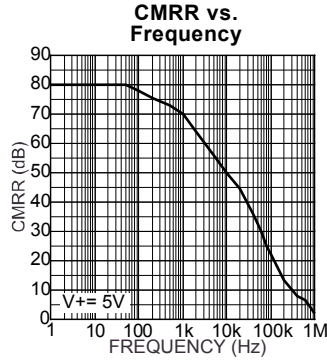
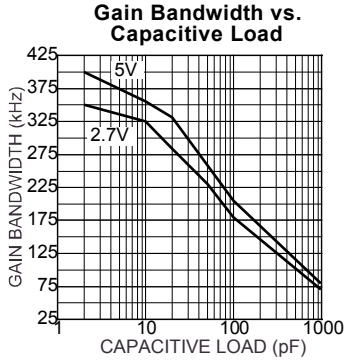

Close-loop Unity Gain Frequency Response

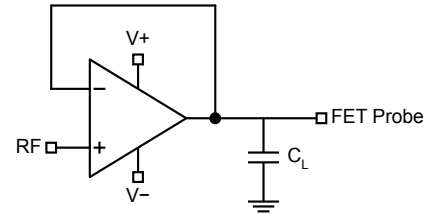
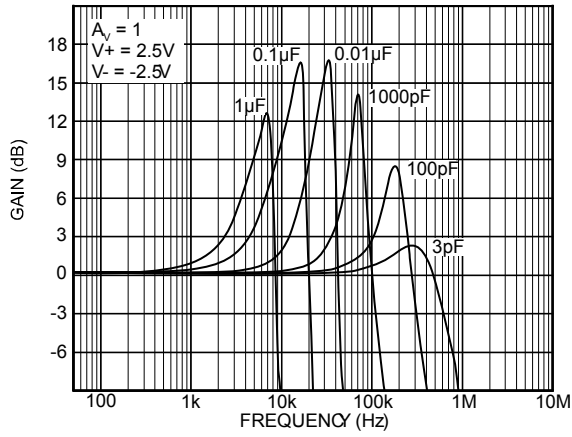

Functional Characteristics

Small Signal Pulse Response
Test Circuit 3: $A_V = 1$

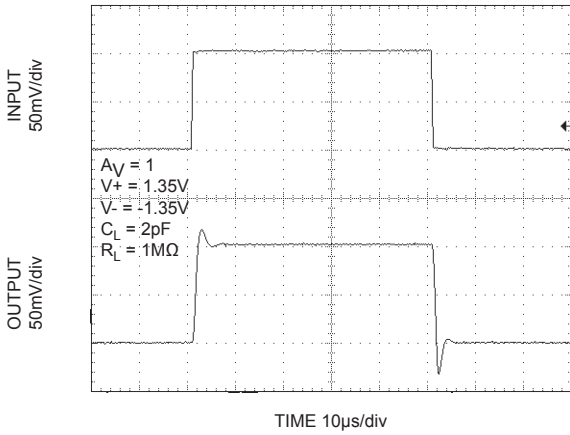

Small Signal Pulse Response
Test Circuit 3: $A_V = 1$

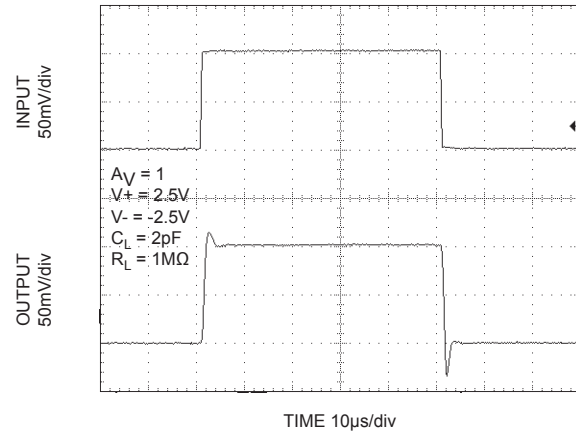

Small Signal Pulse Response
Test Circuit 3: $A_V = 1$

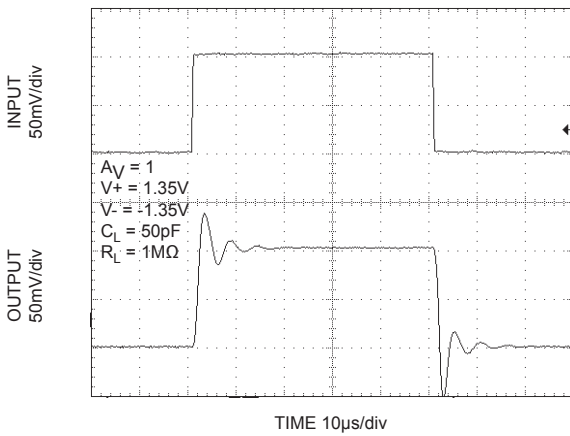

Small Signal Pulse Response
Test Circuit 3: $A_V = 1$

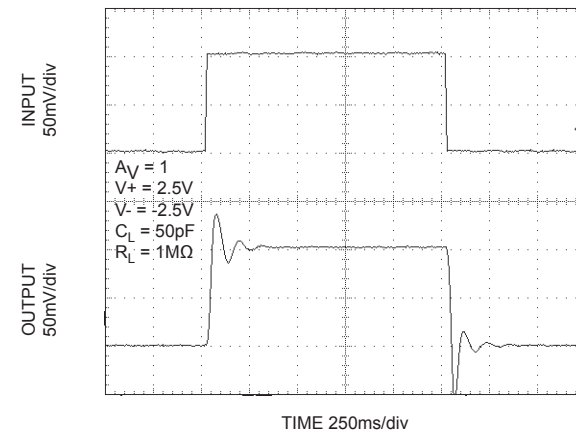

Small Signal Pulse Response
Test Circuit 4: $A_V = -1$

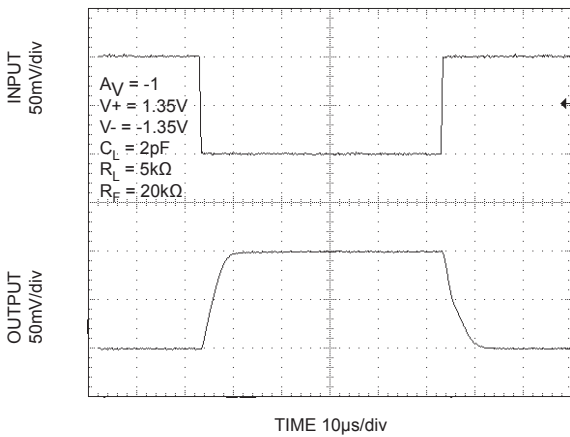

Small Signal Pulse Response
Test Circuit 4: $A_V = -1$

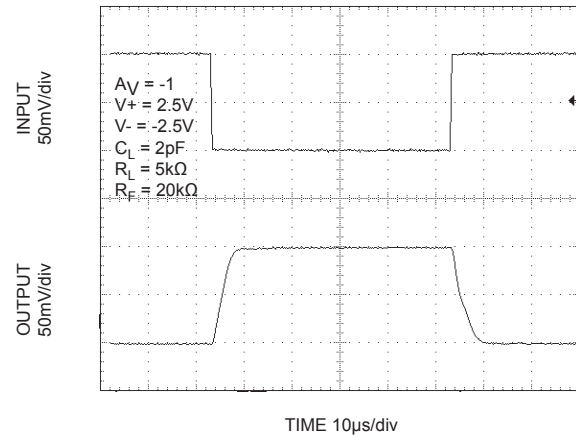

Small Signal Pulse Response
Test Circuit 4: $A_V = -1$

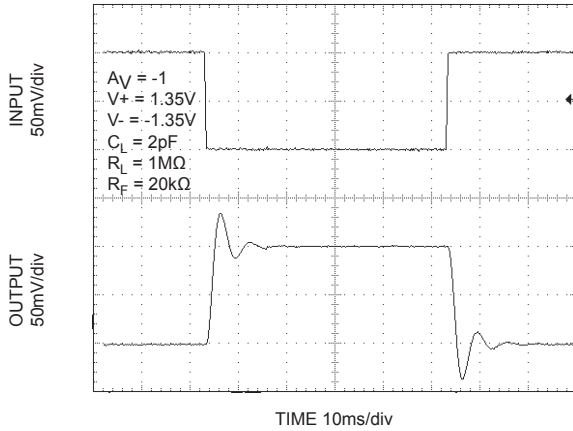

Small Signal Pulse Response
Test Circuit 4: $A_V = -1$

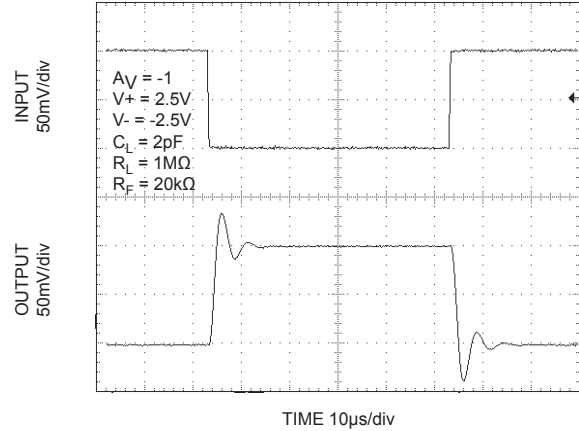

Rail to Rail Output Operation

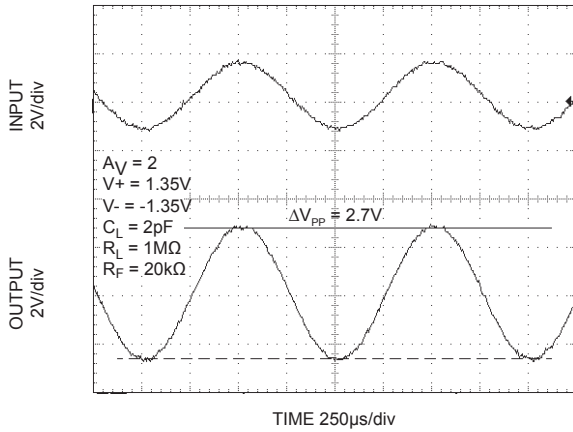

Rail to Rail Output Operation

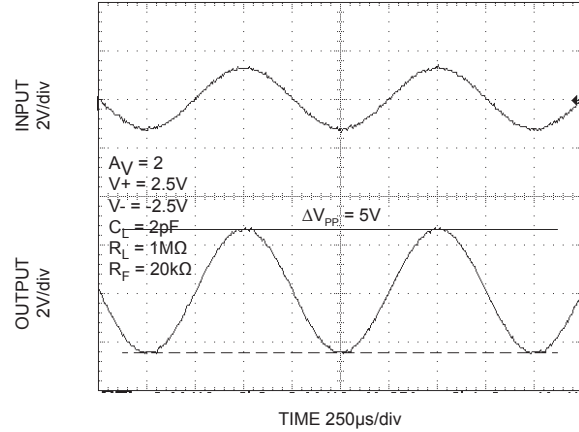

Rail to Rail Output Operation

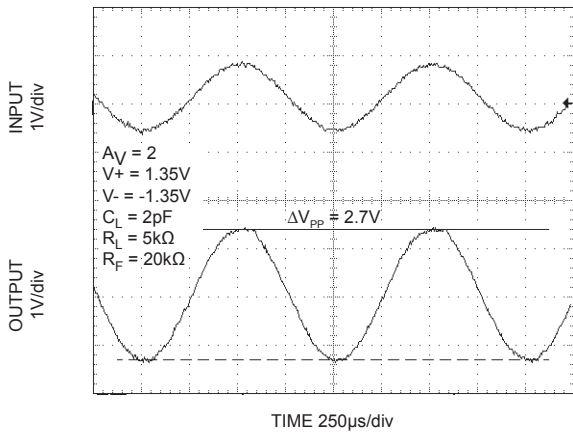

Rail to Rail Output Operation

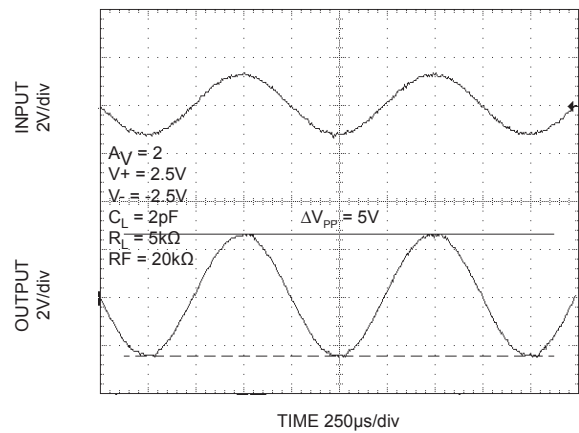

Large Signal Pulse Response
Test Circuit 3: $A_V = 1$

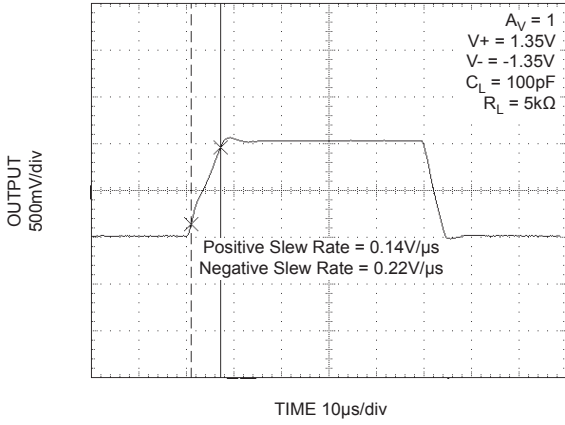

Large Signal Pulse Response
Test Circuit 3: $A_V = 1$

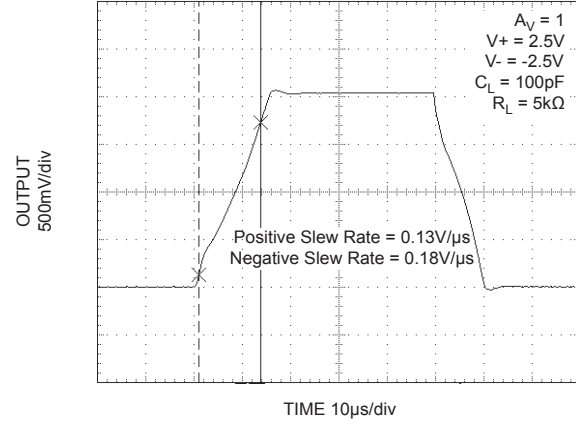

Applications Information

Power Supply Bypassing

Regular supply bypassing techniques are recommended. A 10 μ F capacitor in parallel with a 0.1 μ F capacitor on both the positive and negative supplies are ideal. For best performance all bypassing capacitors should be located as close to the op amp as possible and all capacitors should be low ESL (equivalent series inductance), ESR (equivalent series resistance). Surface-mount ceramic capacitors are ideal.

Package Information

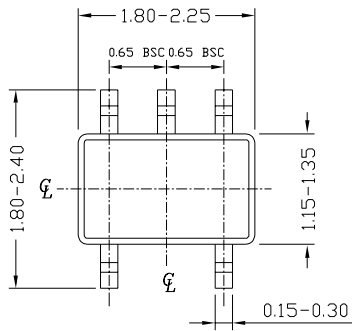

TOP VIEW

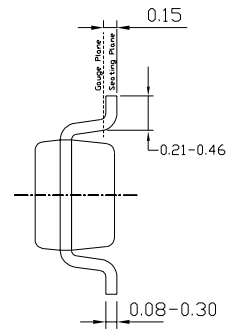

END VIEW

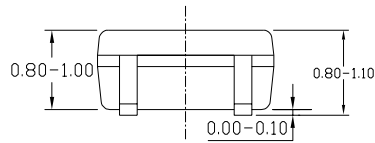

SIDE VIEW

NOTE:

1. ALL DIMENSIONS ARE IN MILLIMETERS.
2. DIMENSIONS ARE INCLUSIVE OF PLATING.
3. DIMENSIONS ARE EXCLUSIVE OF MOLD FLASH & METAL BURR.

SC70-5

MICREL INC. 2180 FORTUNE DRIVE SAN JOSE, CA 95131 USA
 TEL + 1 (408) 944-0800 FAX + 1 (408) 474-1000 WEB <http://www.micrel.com>

This information furnished by Micrel in this data sheet is believed to be accurate and reliable. However no responsibility is assumed by Micrel for its use. Micrel reserves the right to change circuitry and specifications at any time without notification to the customer.

Micrel Products are not designed or authorized for use as components in life support appliances, devices or systems where malfunction of a product can reasonably be expected to result in personal injury. Life support devices or systems are devices or systems that (a) are intended for surgical implant into the body or (b) support or sustain life, and whose failure to perform can be reasonably expected to result in a significant injury to the user. A Purchaser's use or sale of Micrel Products for use in life support appliances, devices or systems is a Purchaser's own risk and Purchaser agrees to fully indemnify Micrel for any damages resulting from such use or sale.