

DATA SHEET

NEC

PHOTOCOUPLER PS2707-1, PS2707-2, PS2707-4

AC INPUT RESPONSE HIGH COLLECTOR TO EMITTER VOLTAGE TYPE SOP MULTI PHOTOCOUPLER SERIES

–NEPOC™ Series–

DESCRIPTION

The PS2707-1, PS2707-2, PS2707-4 are optically coupled isolators containing GaAs light emitting diodes and an NPN silicon phototransistor.

Each is mounted in a plastic SOP (Small Outline Package) for high density applications.

This package has shield effect to cut off ambient light.

FEATURES

- AC input response
- High collector to emitter voltage ($V_{CEO} = 120\text{ V}$)
- High isolation voltage ($BV = 3\,750\text{ Vr.m.s.}$)
- Small and thin (SOP) package
- High-speed switching ($t_r, t_f = 10\ \mu\text{s TYP.}$)
- Ordering number of taping product (1-ch only): PS2707-1-E3, E4, F3, F4
- UL approved: File No. E72422 (S)
- VDE0884 approved (Option)

★ APPLICATIONS

- Hybrid IC
- Telephone/FAX
- FA/OA equipment
- Programmable logic controllers

ORDERING INFORMATION

Part Number	Package	Safety Standard Approval
PS2707-1	4-pin SOP	Standard specification products • UL approved
PS2707-2	8-pin SOP	
PS2707-4	16-pin SOP	
PS2707-1-V	4-pin SOP	VDE0884 specification products (Option)
PS2707-2-V	8-pin SOP	
PS2707-4-V	16-pin SOP	

The information in this document is subject to change without notice. Before using this document, please confirm that this is the latest version.
Not all devices/types available in every country. Please check with local NEC representative for availability and additional information.

PACKAGE DIMENSIONS (in millimeters)

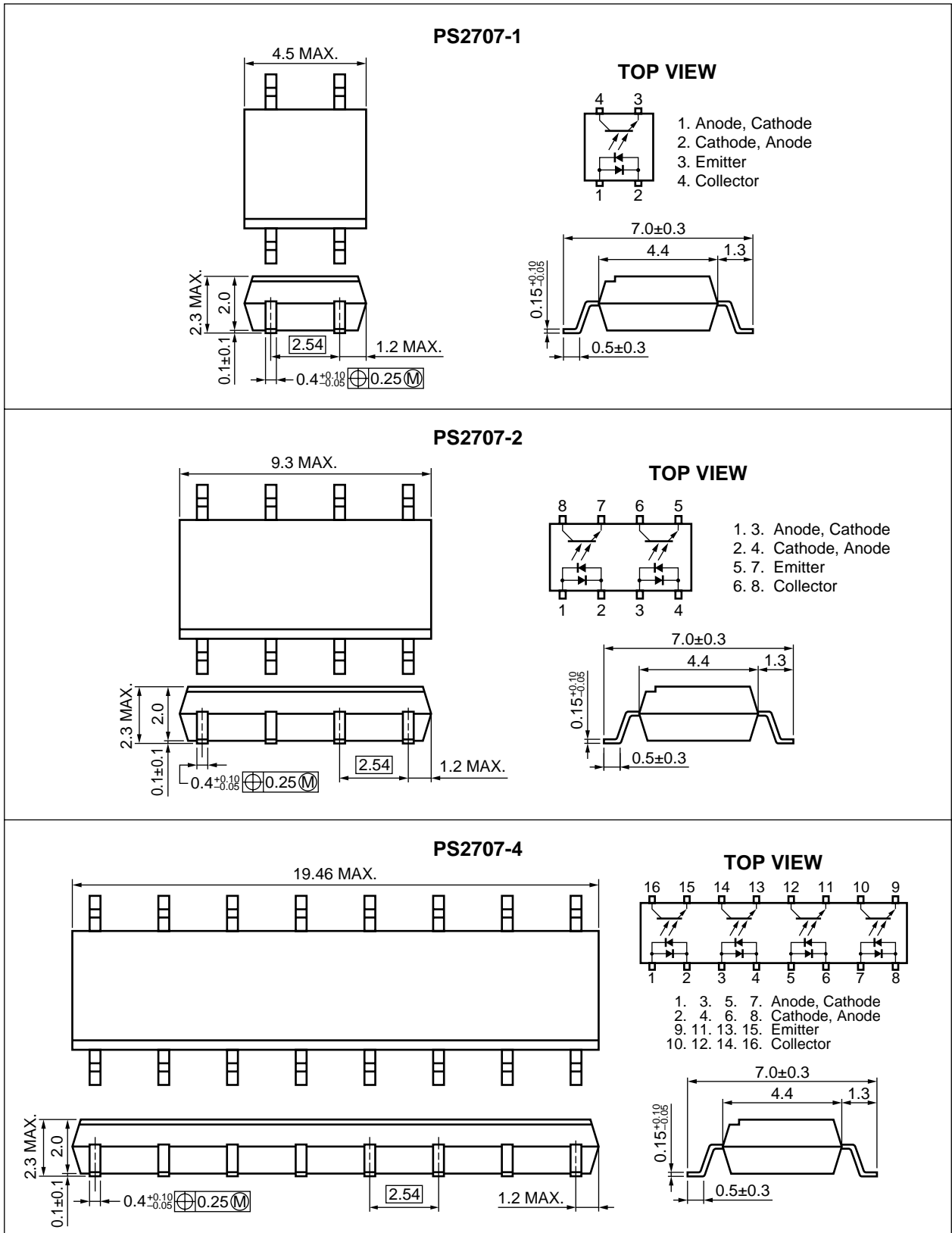

ABSOLUTE MAXIMUM RATINGS (T_A = 25 °C, unless otherwise specified)

Parameter		Symbol	Ratings		Unit
			PS2707-1	PS2707-2, PS2707-4	
Diode	Forward Current (DC)	I _F	± 50		mA
	Power Dissipation Derating	ΔP _D /°C	0.8		mW/°C
	Power Dissipation	P _D	80		mW/ch
	Peak Forward Current ¹	I _{FP}	± 1		A
Transistor	Collector to Emitter Voltage	V _{CEO}	120		V
	Emitter to Collector Voltage	V _{ECO}	6		V
	Collector Current	I _C	30		mA/ch
	Power Dissipation Derating	ΔP _C /°C	1.5	1.2	mW/°C
	Power Dissipation	P _C	150	120	mW/ch
Isolation Voltage ²		BV	3 750		Vr.m.s.
Operating Ambient Temperature		T _A	-55 to +100		°C
Storage Temperature		T _{stg}	-55 to +150		°C

*1 PW = 100 μs, Duty Cycle = 1 %

*2 AC voltage for 1 minute at T_A = 25 °C, RH = 60 % between input and output

ELECTRICAL CHARACTERISTICS (T_A = 25 °C)

Parameter		Symbol	Conditions	MIN.	TYP.	MAX.	Unit
Diode	Forward Voltage	V _F	I _F = ± 5 mA		1.1	1.4	V
	Terminal Capacitance	C _t	V = 0 V, f = 1 MHz		60		pF
Transistor	Collector to Emitter Current	I _{CEO}	I _F = 0 mA, V _{CE} = 120 V			100	nA
Coupled	Current Transfer Ratio (I _c /I _F)	CTR	I _F = ± 5 mA, V _{CE} = 5 V	50	150	400	%
			I _F = ± 1 mA, V _{CE} = 5 V	10	80		
	CTR Ratio ^{*1}	CTR1/CTR2	I _F = ± 5 mA, V _{CE} = 5 V	0.3	1.0	3.0	
	Collector Saturation Voltage	V _{CE(sat)}	I _F = ± 10 mA, I _c = 2 mA			0.3	V
	Isolation Resistance	R _{I-O}	V _{I-O} = 1 kV _{DC}	10 ¹¹			Ω
	Isolation Capacitance	C _{I-O}	V = 0 V, f = 1 MHz		0.4		pF
	Rise Time ^{*2}	t _r	V _{CC} = 5 V, I _c = 2 mA, R _L = 1 kΩ		10		μs
	Fall Time ^{*2}	t _f			10		

*1 CTR1 = I_{c1}/I_{F1}, CTR2 = I_{c2}/I_{F2}

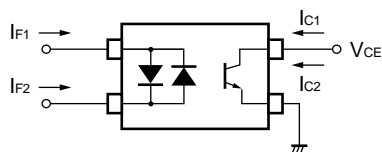

★ *2 Test circuit for switching time

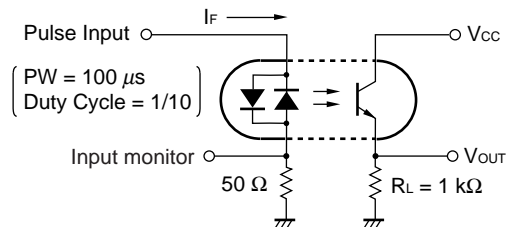

★ TYPICAL CHARACTERISTICS (T_A = 25 °C, unless otherwise specified)

DIODE POWER DISSIPATION vs. AMBIENT TEMPERATURE

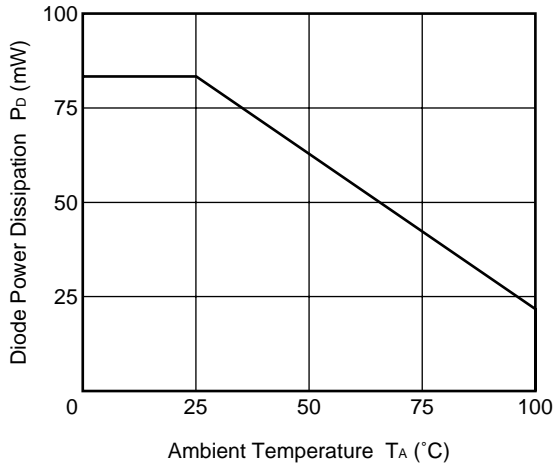

TRANSISTOR POWER DISSIPATION vs. AMBIENT TEMPERATURE

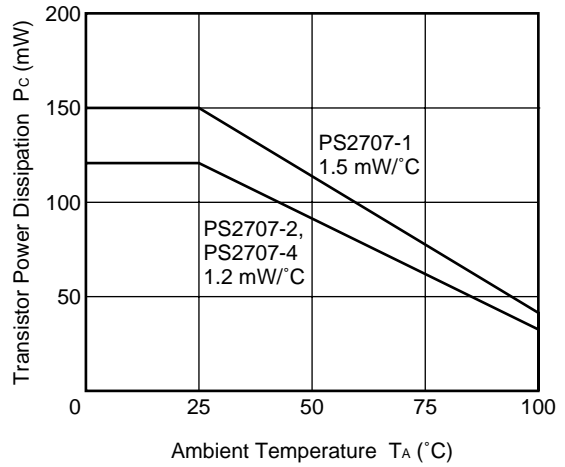

FORWARD CURRENT vs. FORWARD VOLTAGE

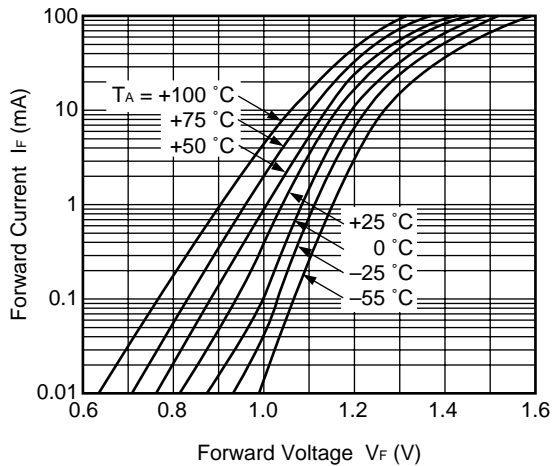

FORWARD CURRENT vs. FORWARD VOLTAGE

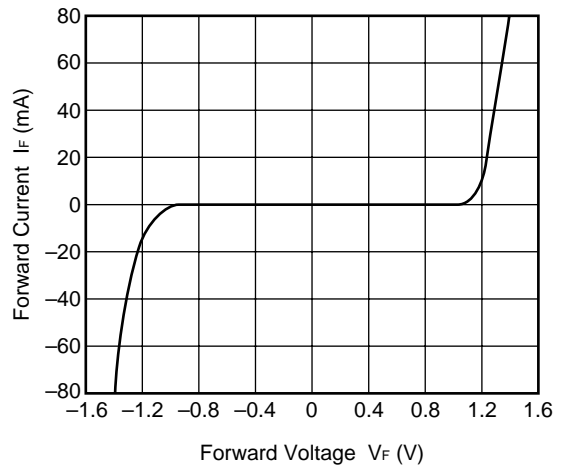

COLLECTOR TO EMITTER DARK CURRENT vs. AMBIENT TEMPERATURE

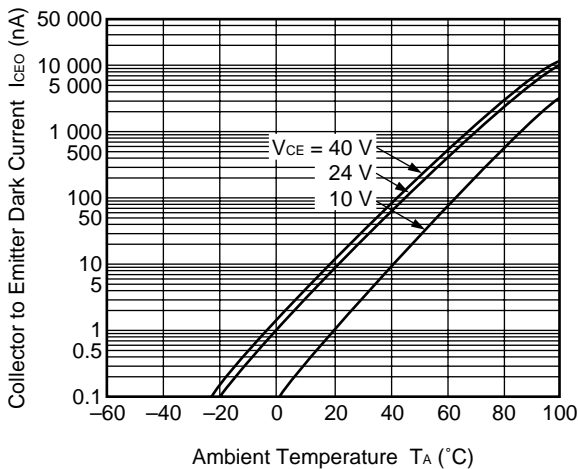

COLLECTOR CURRENT vs. COLLECTOR SATURATION VOLTAGE

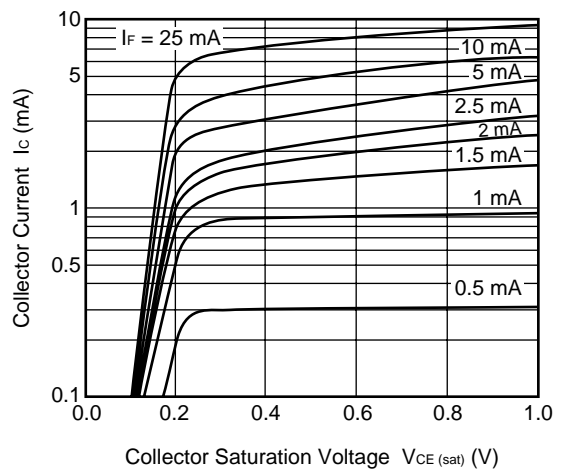

COLLECTOR CURRENT vs. COLLECTOR TO EMITTER VOLTAGE

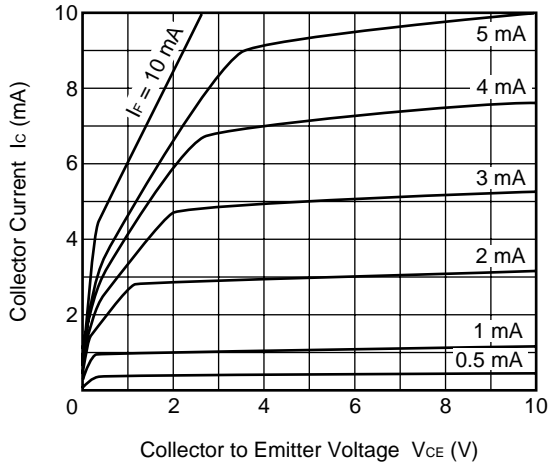

NORMALIZED CURRENT TRANSFER RATIO vs. AMBIENT TEMPERATURE

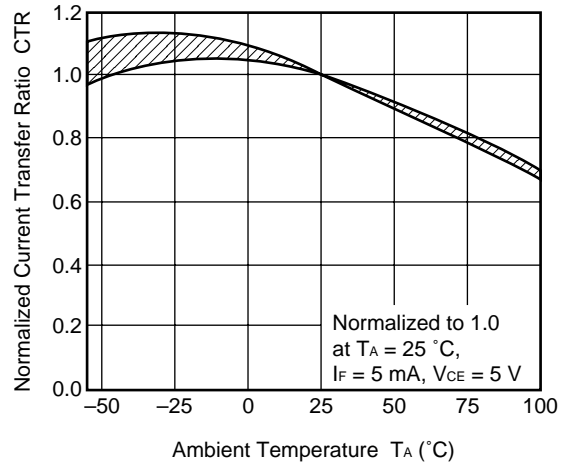

CURRENT TRANSFER RATIO vs. FORWARD CURRENT

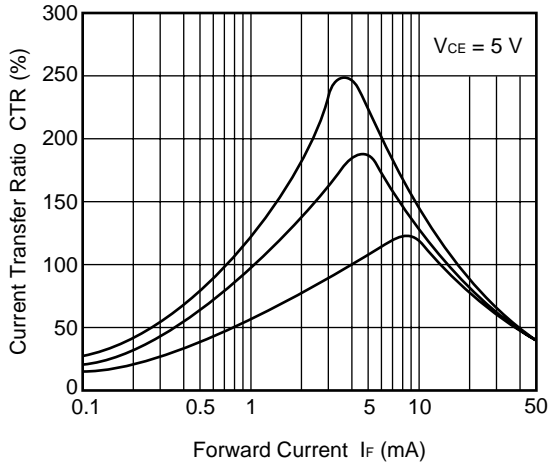

SWITCHING TIME vs. LOAD RESISTANCE

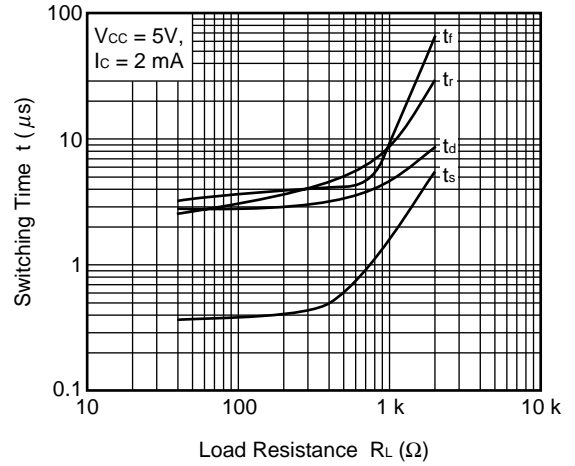

SWITCHING TIME vs. LOAD RESISTANCE

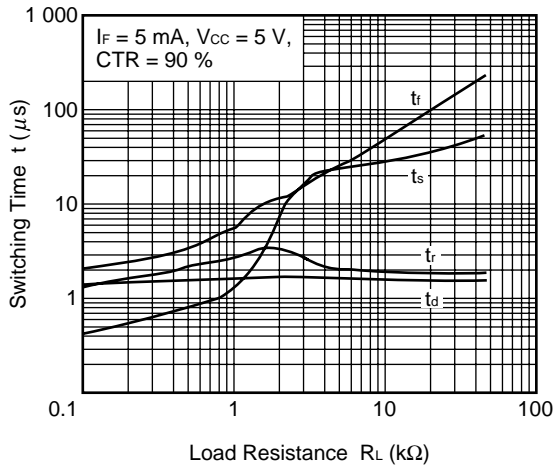

FREQUENCY RESPONSE

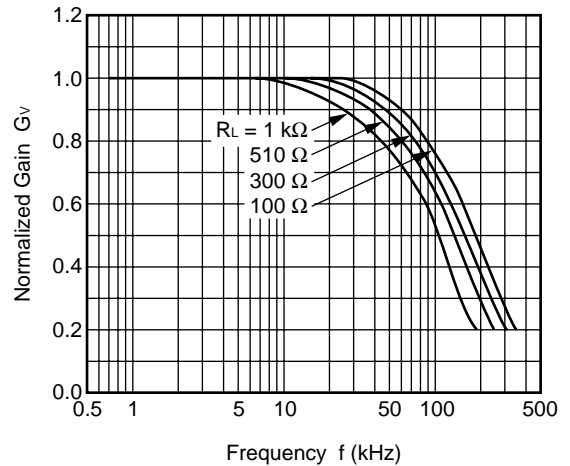

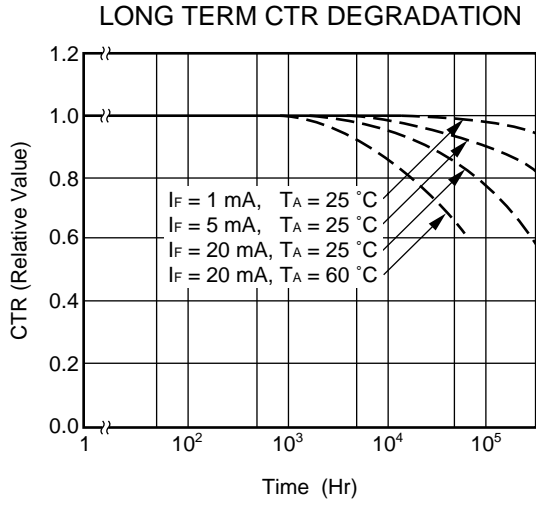

Remark The graphs indicate nominal characteristics.

★ TAPING SPECIFICATIONS (in millimeters)

Outline and Dimensions (Tape)

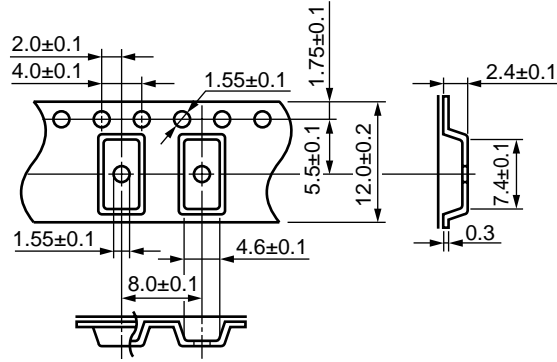

Tape Direction

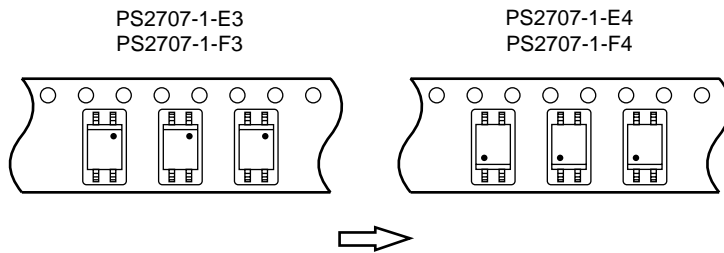

Outline and Dimensions (Reel)

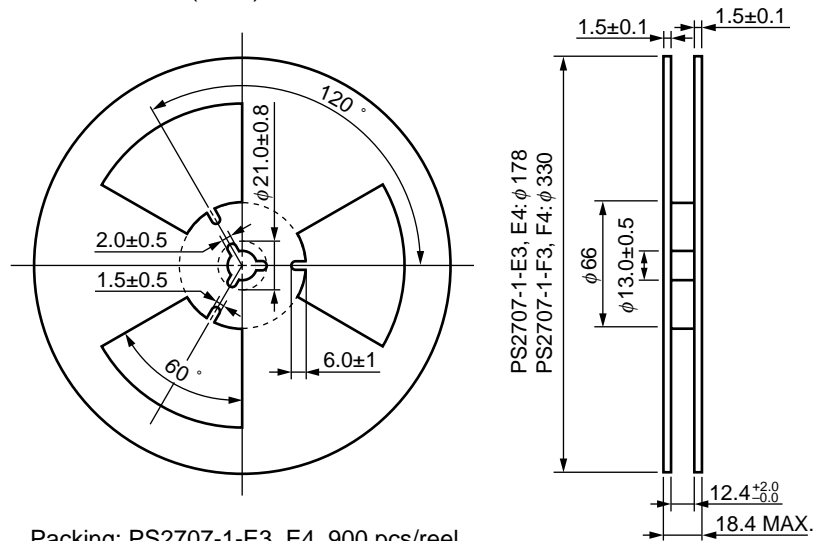

Packing: PS2707-1-E3, E4 900 pcs/reel
 PS2707-1-F3, F4 3 500 pcs/reel

★ **RECOMMENDED SOLDERING CONDITIONS**

(1) Infrared reflow soldering

- Peak reflow temperature 235 °C (package surface temperature)
- Time of temperature higher than 210 °C 30 seconds or less
- Number of reflows Three
- Flux Rosin flux containing small amount of chlorine (The flux with a maximum chlorine content of 0.2 Wt % is recommended.)

Recommended Temperature Profile of Infrared Reflow

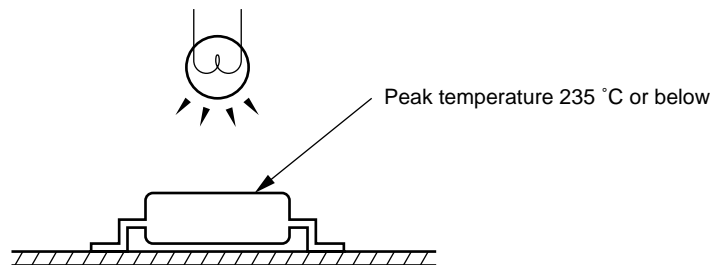
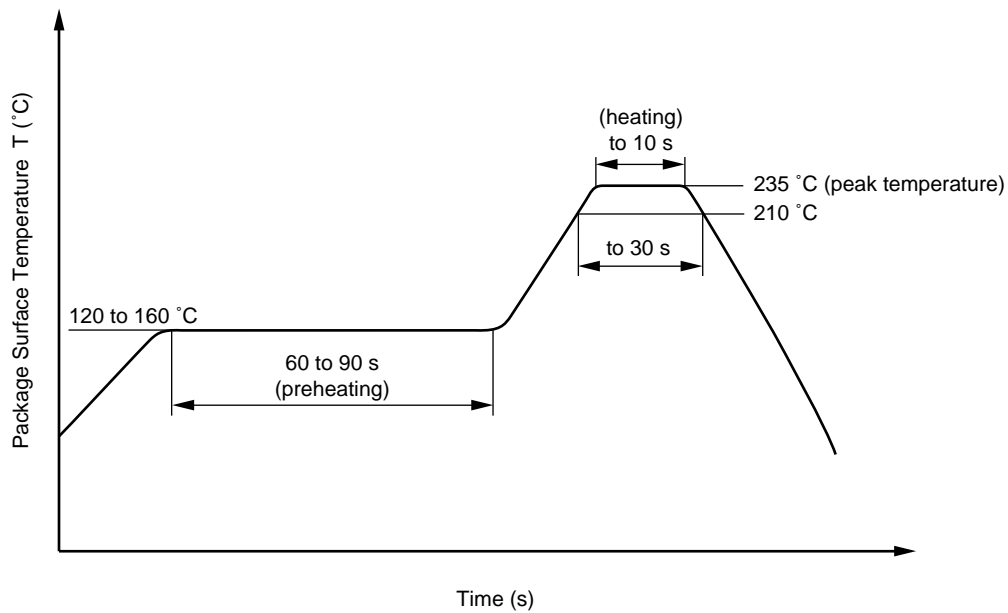

(2) Dip soldering

- Temperature 260 °C or below (molten solder temperature)
- Time 10 seconds or less
- Number of times One
- Flux Rosin flux containing small amount of chlorine (The flux with a maximum chlorine content of 0.2 Wt % is recommended.)

(3) Cautions

- Fluxes
Avoid removing the residual flux with freon-based and chlorine-based cleaning solvent.

SPECIFICATION OF VDE MARKS LICENSE DOCUMENT (VDE0884)

Parameter	Symbol	Speck	Unit
Application classification (DIN VDE 0109) for rated line voltages ≤ 300 Vr.m.s. for rated line voltages ≤ 600 Vr.m.s.		IV III	
Climatic test class (DIN IEC 68 Teil 1/09.80)		55/100/21	
Dielectric strength maximum operating isolation voltage Test voltage (partial discharge test, procedure a for type test and random test) $U_{pr} = 1.2 \times U_{IORM}, P_d < 5$ pC	U_{IORM} U_{pr}	710 850	V_{peak} V_{peak}
Test voltage (partial discharge test, procedure b for random test) $U_{pr} = 1.6 \times U_{IORM}, P_d < 5$ pC	U_{pr}	1 140	V_{peak}
Highest permissible overvoltage	U_{TR}	6 000	V_{peak}
Degree of pollution (DIN VDE 0109)		2	
Clearance distance		> 5	mm
Creepage distance		> 5	mm
Comparative tracking index (DIN IEC 112/VDE 0303 part 1)	CTI	175	
Material group (DIN VDE 0109)		III a	
Storage temperature range	T_{stg}	-55 to +150	°C
Operating temperature range	T_A	-55 to +100	°C
Isolation resistance, minimum value $V_{IO} = 500$ V dc at $T_A = 25$ °C $V_{IO} = 500$ V dc at T_A MAX. at least 100 °C	Ris MIN. Ris MIN.	10^{12} 10^{11}	Ω Ω
Safety maximum ratings (maximum permissible in case of fault, see thermal derating curve) Package temperature Current (input current $I_F, P_{si} = 0$) Power (output or total power dissipation) Isolation resistance $V_{IO} = 500$ V dc at $T_A = 175$ °C (T_{si})	T_{si} I_{si} P_{si} Ris MIN.	150 200 300 10^9	°C mA mW Ω

[MEMO]

CAUTION

Within this device there exists GaAs (Gallium Arsenide) material which is a harmful substance if ingested. Please do not under any circumstances break the hermetic seal.

NEPOC is a trademark of NEC Corporation.

- **The information in this document is subject to change without notice. Before using this document, please confirm that this is the latest version.**
 - No part of this document may be copied or reproduced in any form or by any means without the prior written consent of NEC Corporation. NEC Corporation assumes no responsibility for any errors which may appear in this document.
 - NEC Corporation does not assume any liability for infringement of patents, copyrights or other intellectual property rights of third parties by or arising from use of a device described herein or any other liability arising from use of such device. No license, either express, implied or otherwise, is granted under any patents, copyrights or other intellectual property rights of NEC Corporation or others.
 - Descriptions of circuits, software, and other related information in this document are provided for illustrative purposes in semiconductor product operation and application examples. The incorporation of these circuits, software, and information in the design of the customer's equipment shall be done under the full responsibility of the customer. NEC Corporation assumes no responsibility for any losses incurred by the customer or third parties arising from the use of these circuits, software, and information.
 - While NEC Corporation has been making continuous effort to enhance the reliability of its semiconductor devices, the possibility of defects cannot be eliminated entirely. To minimize risks of damage or injury to persons or property arising from a defect in an NEC semiconductor device, customers must incorporate sufficient safety measures in its design, such as redundancy, fire-containment, and anti-failure features.
 - NEC devices are classified into the following three quality grades:
"Standard", "Special", and "Specific". The Specific quality grade applies only to devices developed based on a customer designated "quality assurance program" for a specific application. The recommended applications of a device depend on its quality grade, as indicated below. Customers must check the quality grade of each device before using it in a particular application.
 - Standard: Computers, office equipment, communications equipment, test and measurement equipment, audio and visual equipment, home electronic appliances, machine tools, personal electronic equipment and industrial robots
 - Special: Transportation equipment (automobiles, trains, ships, etc.), traffic control systems, anti-disaster systems, anti-crime systems, safety equipment and medical equipment (not specifically designed for life support)
 - Specific: Aircraft, aerospace equipment, submersible repeaters, nuclear reactor control systems, life support systems or medical equipment for life support, etc.
- The quality grade of NEC devices is "Standard" unless otherwise specified in NEC's Data Sheets or Data Books. If customers intend to use NEC devices for applications other than those specified for Standard quality grade, they should contact an NEC sales representative in advance.