

FEATURES

- **HIGH DENSITY SURFACE MOUNTING:**
6 pin super minimold or SOT-363 package
- **LOW SUPPLY VOLTAGE:** $V_{CC} = 1.8$ to 3.3 V
- **WIDEBAND RESPONSE:**
UPC2745TB: $f_u = 2.7$ GHz TYP
UPC2746TB: $f_u = 1.5$ GHz TYP
- **HIGH ISOLATION:**
UPC2745TB: ISOL = 38 dB TYP
UPC2746TB: ISOL = 45 dB TYP

DESCRIPTION

The UPC2745TB and UPC2746TB are Silicon MMIC Wideband Amplifiers manufactured using NEC's 20 GHz f_T NESAT™ III silicon bipolar process. These devices are designed for use as buffer amps in mobile communication applications such as Cellular, PCS, and Cordless handsets, and WLAN transceivers. The UPC2745/46TB are pin compatible and have comparable performance as the larger UPC2745/46T, so they are suitable for use as a replacement to help reduce system size. These IC's are housed in a 6 pin super minimold or SOT-363 package.

NEC's stringent quality assurance and test procedure ensure the highest reliability and performance.

TYPICAL PERFORMANCE CURVES

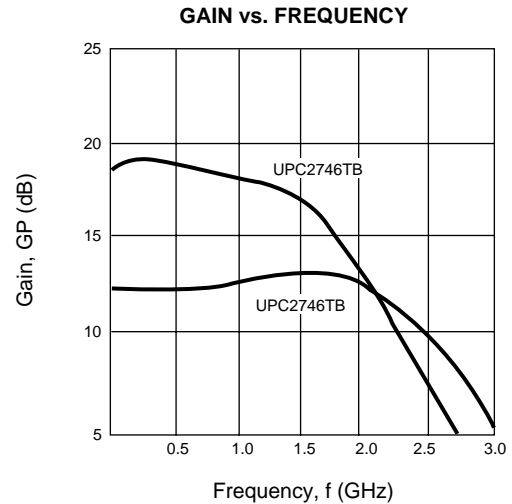

ELECTRICAL CHARACTERISTICS ($T_A = +25$ °C, $Z_L = Z_S = 50$ Ω)

PART NUMBER PACKAGE OUTLINE			UPC2745TB S06			UPC2746TB S06		
SYMBOLS	PARAMETERS AND CONDITIONS	UNITS	MIN	TYP	MAX	MIN	TYP	MAX
I _{CC}	Circuit Current (no signal), $V_{CC} = 3.0$ V $V_{CC} = 1.8$ V	mA mA	5.0	7.5 4.5	10.0	5.0	7.5 4.5	10.0
GP	Power Gain, $V_{CC} = 3.0$ V, $f = 0.5$ GHz $V_{CC} = 3.0$ V, $f = 1$ GHz $V_{CC} = 3.0$ V, $f = 2$ GHz $V_{CC} = 1.8$ V, $f = 500$ MHz	dB dB dB dB	9.0	12 12 11 7	14	16	19 18.5 14	21
f_u	Upper Limit Operating Frequency (3 dB down from the gain at $f = 100$ MHz) $V_{CC} = 3.0$ V $V_{CC} = 1.8$ V	GHz GHz	2.3	2.7 1.8		1.1	1.5 1.1	
P _{O(SAT)}	Maximum Output Level $V_{CC} = 3.0$ V, $f = 0.5$ GHz, P _{IN} = -6 dBm $V_{CC} = 3.0$ V, $f = 1$ GHz, P _{IN} = -6 dBm $V_{CC} = 3.0$ V, $f = 2$ GHz, P _{IN} = -6 dBm $V_{CC} = 1.8$ V, $f = 500$ MHz, P _{IN} = -10 dBm	dBm dBm dBm dBm	-4	-1 -2.5 -3.5 -11		-3	0 -1 -8	
NF	Noise Figure, $V_{CC} = 3.0$ V, $f = 0.5$ GHz $V_{CC} = 3.0$ V, $f = 1$ GHz $V_{CC} = 3.0$ V, $f = 2$ GHz $V_{CC} = 1.8$ V, $f = 500$ MHz	dB dB dB dB		6 5.5 5.7 8.0	7.5		4.0 4.2 5.0	5.5

ELECTRICAL CHARACTERISTICS ($T_A = +25\text{ }^\circ\text{C}$, $Z_L = Z_S = 50\ \Omega$)

PART NUMBER PACKAGE OUTLINE			UPC2745TB S06			UPC2746TB S06		
SYMBOLS	PARAMETERS AND CONDITIONS	UNITS	MIN	TYP	MAX	MIN	TYP	MAX
RLIN	Input Return Loss, $V_{CC} = 3.0\text{ V}$, $f = 0.5\text{ GHz}$ $V_{CC} = 3.0\text{ V}$, $f = 1\text{ GHz}$ $V_{CC} = 3.0\text{ V}$, $f = 2\text{ GHz}$ $V_{CC} = 1.8\text{ V}$, $f = 0.5\text{ GHz}$	dB dB dB dB	8	11 13 14 6.5		10	13 10 10	
ROUT	Output Return Loss, $V_{CC} = 3.0\text{ V}$, $f = 0.5\text{ GHz}$ $V_{CC} = 3.0\text{ V}$, $f = 1\text{ GHz}$ $V_{CC} = 3.0\text{ V}$, $f = 2\text{ GHz}$ $V_{CC} = 1.8\text{ V}$, $f = 0.5\text{ GHz}$	dB dB dB dB	2.5	5.5 6.5 8.5 6.0		5.5	8.5 8.5 9.5	
ISOL	Isolation, $V_{CC} = 3.0\text{ V}$, $f = 0.5\text{ GHz}$ $V_{CC} = 3.0\text{ V}$, $f = 1\text{ GHz}$ $V_{CC} = 3.0\text{ V}$, $f = 2\text{ GHz}$ $V_{CC} = 1.8\text{ V}$, $f = 0.5\text{ GHz}$	dB dB dB dB	33	38 33 30 35		40	45 38 37	
IM3	3rd Order Intermodulation Distortion $V_{CC} = 3.0\text{ V}$, $P_{OUT} = -20\text{ dBm}$, $f_1 = 500\text{ MHz}$, $f_2 = 502\text{ MHz}$ $V_{CC} = 3.0\text{ V}$, $P_{OUT} = -20\text{ dBm}$, $f_1 = 1000\text{ MHz}$, $f_2 = 1002\text{ MHz}$ $V_{CC} = 1.8\text{ V}$, $P_{OUT} = -20\text{ dBm}$, $f_1 = 500\text{ MHz}$, $f_2 = 502\text{ MHz}$	dBc dBc dBc		-54 -50 -31			-51 -37	

ABSOLUTE MAXIMUM RATINGS¹ ($T_A = 25\text{ }^\circ\text{C}$)

SYMBOLS	PARAMETERS	UNITS	RATINGS
VCC	Supply Voltage (Pin 5, Pin 8)	V	4.0
PIN	Input Power	dBm	0
PT	Total Power Dissipation ²	mW	200
TOP	Operating Temperature	$^\circ\text{C}$	-45 to +85
TSTG	Storage Temperature	$^\circ\text{C}$	-55 to +150

RECOMMENDED OPERATING CONDITIONS

SYMBOL	PARAMETER	UNITS	MIN	TYP	MAX
VCC	Supply Voltage	V	2.7	3.0	3.3
TOP	Operating Temperature	$^\circ\text{C}$	-40	+25	+85

Notes:

- Operation in excess of any one of these parameters may result in permanent damage.
- Mounted on double sided copper clad 50 x 50 x 1.6 mm epoxy glass PWB ($T_A = +85\text{ }^\circ\text{C}$).

PIN DESCRIPTION

Pin No.	Pin Name	Applied Voltage (V)	Description	Internal Equivalent Circuit
1	Input		Signal input pin. An internal matching circuit, configured with resistors, enables $50\ \Omega$ connection over a wide bandwidth. This pin must be coupled to the signal source with a blocking capacitor.	
4	Output		Signal output pin. An internal matching circuit, configured with resistors, enables $50\ \Omega$ connection over a wide bandwidth. This pin must be coupled to the output load with a blocking capacitor.	
6	VCC	2.7 to 3.3	Power supply pin. This pin should be externally equipped with a bypass capacitor to minimize ground impedance.	
2 3 5	GND	0	Ground pin. This pin should be connected to system ground with minimum inductance. Ground pattern on the board should be formed as wide as possible. All the ground pins must be connected together with wide ground pattern to minimize impedance difference.	

TYPICAL PERFORMANCE CURVES (TA = 25°C)

UPC2745TB
CURRENT vs. VOLTAGE

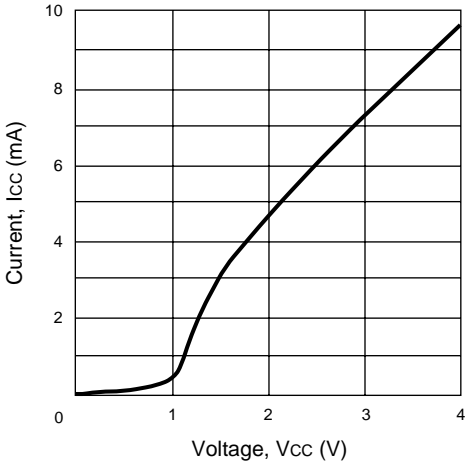

UPC2745TB
CURRENT vs. TEMPERATURE AND VOLTAGE

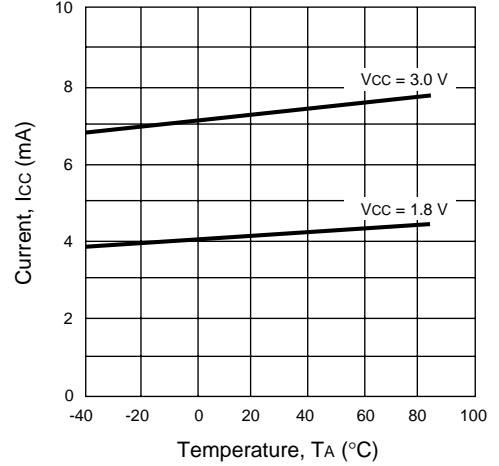

UPC2745TB
GAIN AND NOISE FIGURE vs.
FREQUENCY AND VOLTAGE

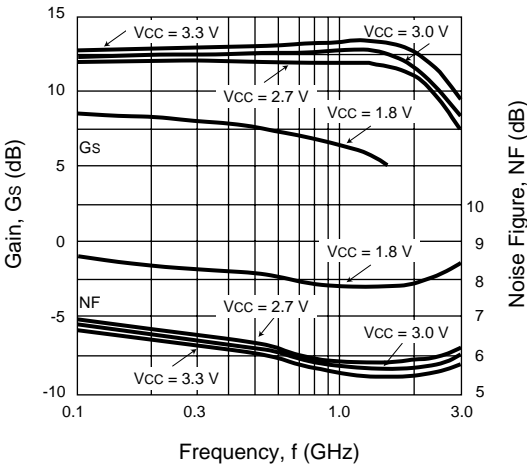

UPC2745TB
GAIN vs.
FREQUENCY AND TEMPERATURE

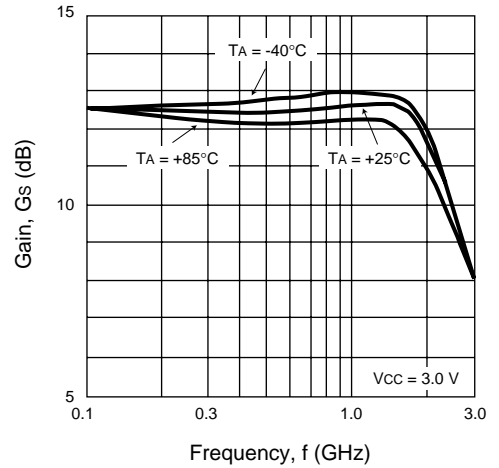

UPC2745TB
ISOLATION vs.
FREQUENCY AND VOLTAGE

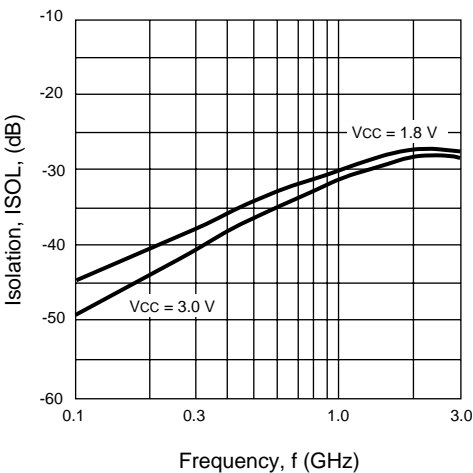

UPC2745TB
INPUT RETURN LOSS AND OUTPUT RETURN
LOSS vs. FREQUENCY AND VOLTAGE

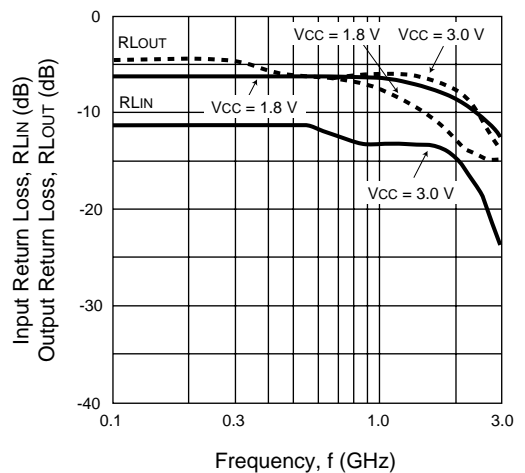

TYPICAL PERFORMANCE CURVES (TA = 25°C)

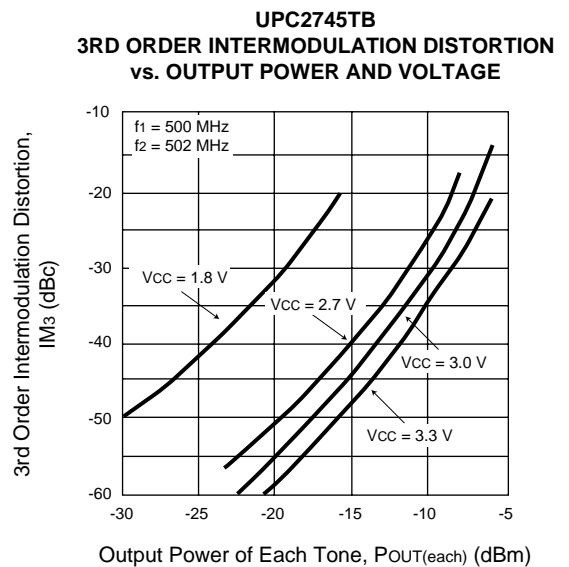
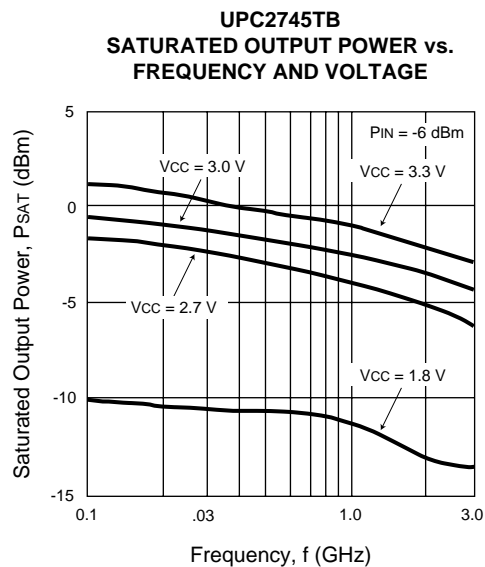
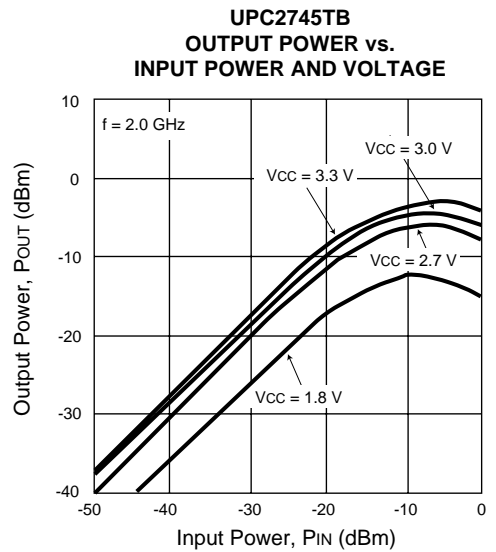
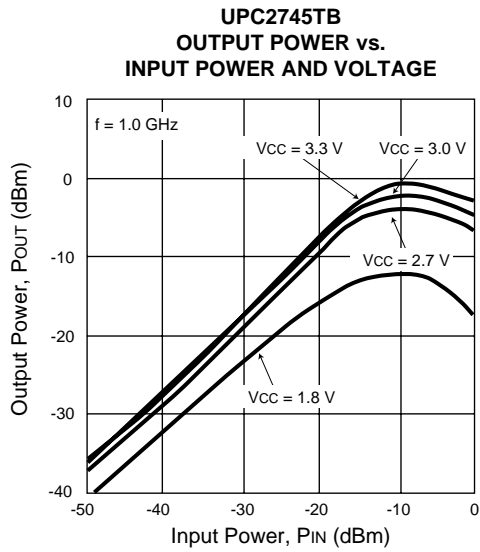
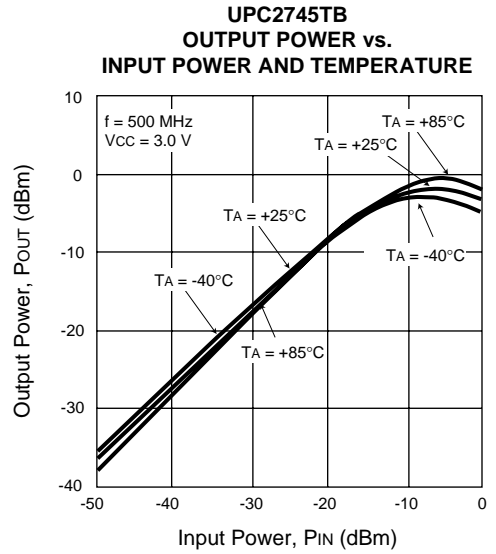
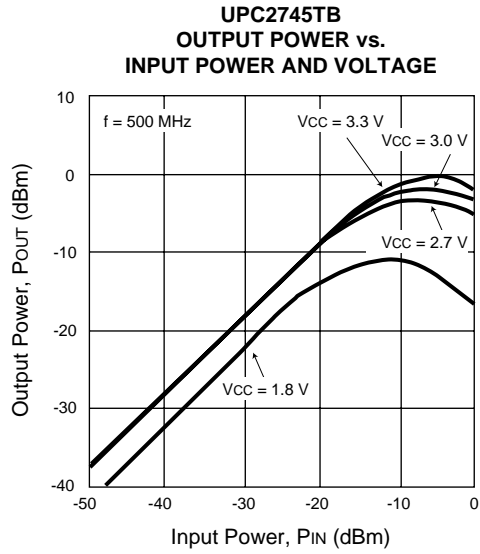

TYPICAL PERFORMANCE CURVES (TA = 25°C)

UPC2746TB
CURRENT vs. VOLTAGE

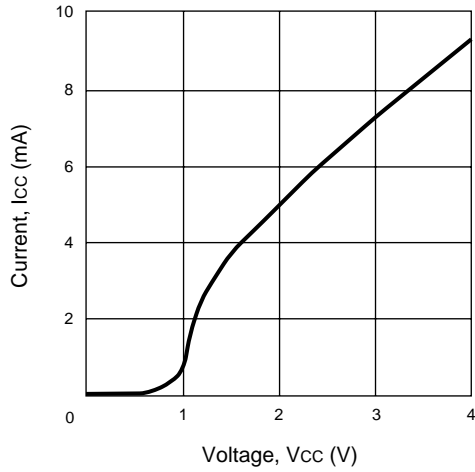

UPC2746TB
CURRENT vs. TEMPERATURE AND VOLTAGE

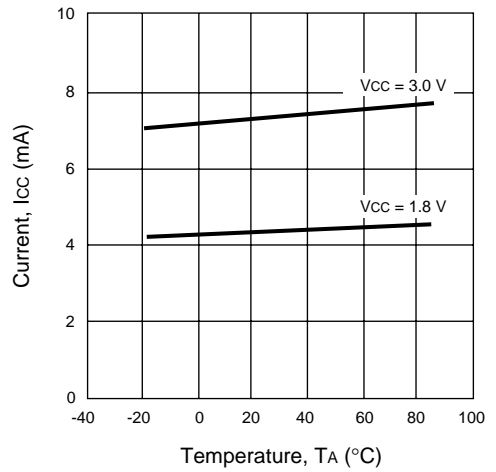

UPC2746TB
GAIN AND NOISE FIGURE vs.
FREQUENCY AND VOLTAGE

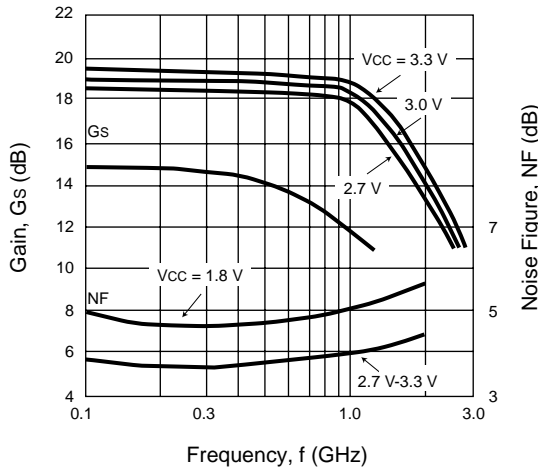

UPC2746TB
GAIN vs.
FREQUENCY AND TEMPERATURE

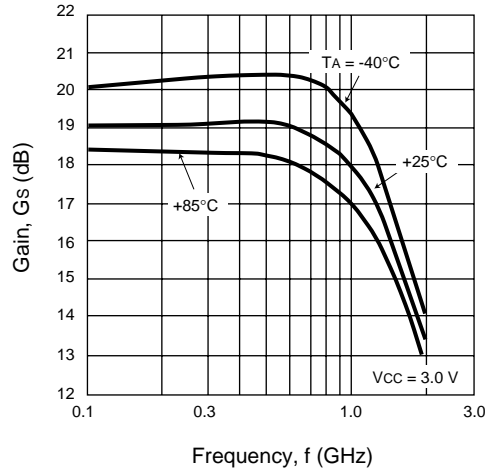

UPC2746TB
ISOLATION vs.
FREQUENCY AND VOLTAGE

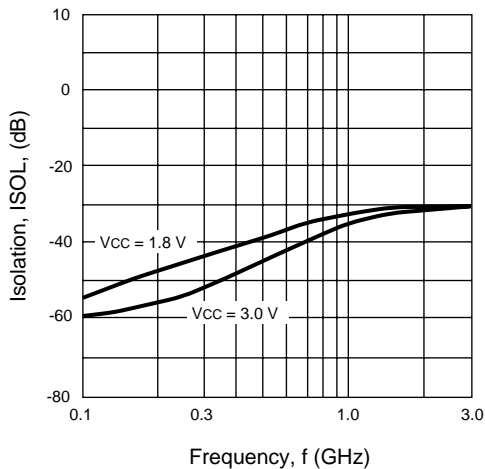

UPC2746TB
INPUT RETURN LOSS AND OUTPUT RETURN
LOSS vs. FREQUENCY AND VOLTAGE

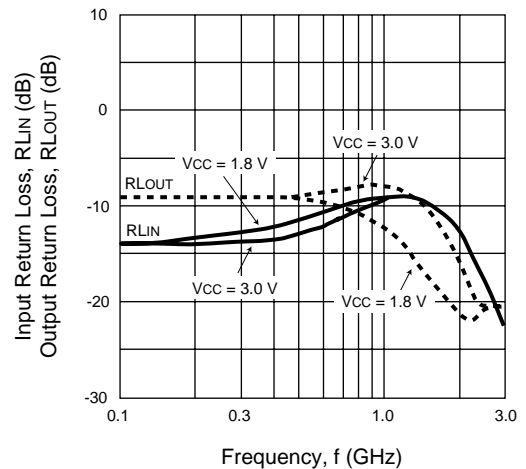

TYPICAL PERFORMANCE CURVES (TA = 25°C)

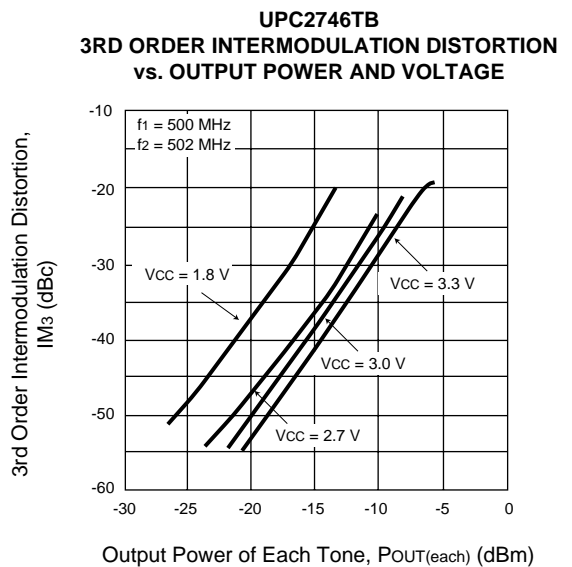
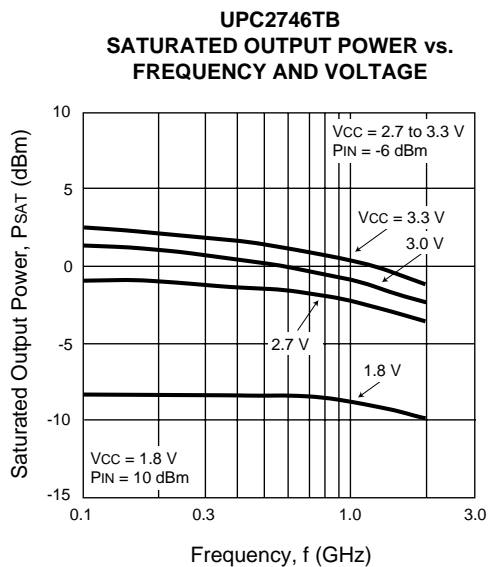
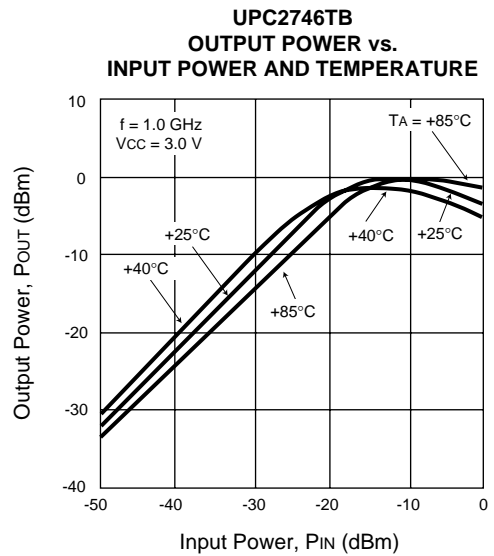
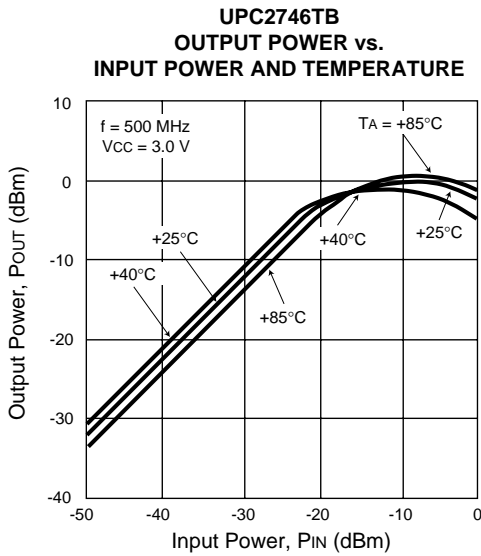
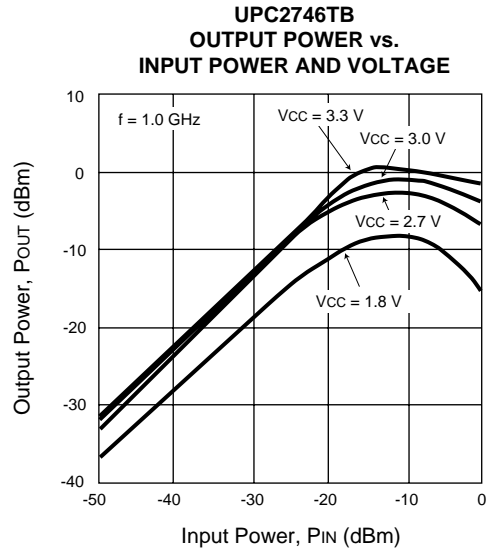
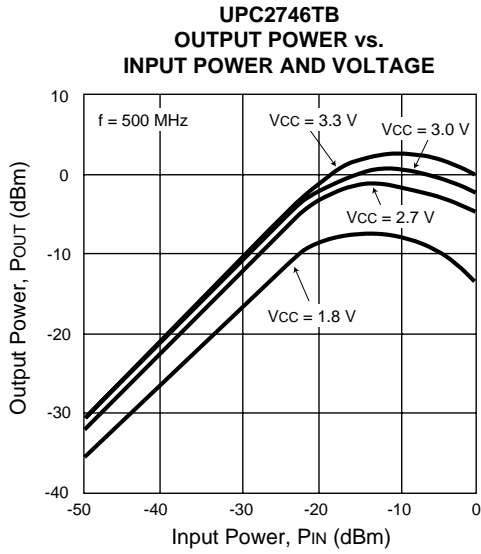

TYPICAL SCATTERING PARAMETERS ($T_A = 25^\circ\text{C}$)**UPC2745TB**V_{CC} = 3 V, I_{CC} = 8.4 mA

FREQUENCY (MHz)	S ₁₁		S ₂₁		S ₁₂		S ₂₂		K
	MAG	ANG	MAG	ANG	MAG	ANG	MAG	ANG	
100.00	0.318	-3.90	4.055	-17.20	0.003	62.90	0.593	-6.60	20.94
200.00	0.325	-5.90	4.030	-35.50	0.006	54.20	0.584	-12.10	11.68
300.00	0.346	-7.20	3.985	-52.50	0.009	42.00	0.579	-16.50	8.29
400.00	0.341	-8.90	3.916	-70.70	0.012	29.40	0.562	-20.60	6.26
500.00	0.339	-10.80	3.842	-87.30	0.013	11.80	0.546	-23.00	6.29
600.00	0.326	-13.90	3.775	-104.70	0.015	1.60	0.527	-26.20	5.50
700.00	0.311	-20.80	3.668	-121.50	0.017	-11.90	0.515	-29.90	5.46
800.00	0.312	-25.80	3.594	-138.10	0.018	-24.20	0.511	-32.40	5.36
900.00	0.325	-31.90	3.525	-154.20	0.020	-38.40	0.512	-34.80	4.91
1000.00	0.356	-32.80	3.497	-170.30	0.019	-45.90	0.523	-35.80	4.93
1100.00	0.382	-32.70	3.503	173.70	0.020	-54.30	0.525	-36.30	4.56
1200.00	0.416	-31.20	3.542	156.70	0.022	-70.50	0.530	-36.80	4.14
1300.00	0.416	-30.90	3.569	139.10	0.023	-78.40	0.518	-37.50	3.92
1400.00	0.415	-30.80	3.520	121.40	0.025	-88.40	0.509	-38.80	3.53
1500.00	0.393	-30.30	3.501	103.70	0.025	-102.90	0.492	-40.50	3.68
1600.00	0.386	-31.30	3.429	86.80	0.025	-114.10	0.481	-42.50	3.78
1700.00	0.373	-30.50	3.355	69.70	0.026	-125.70	0.474	-43.80	3.68
1800.00	0.369	-31.60	3.303	52.70	0.028	-130.30	0.468	-44.80	3.50
1900.00	0.366	-29.60	3.229	35.80	0.028	-142.50	0.457	-44.80	3.63
2000.00	0.353	-30.00	3.179	18.80	0.030	-152.40	0.440	-45.00	3.62
2100.00	0.344	-28.60	3.081	1.50	0.031	-164.90	0.416	-45.00	3.85
2200.00	0.313	-29.50	2.999	-15.40	0.031	-177.10	0.389	-45.40	4.23
2300.00	0.293	-31.60	2.911	-32.50	0.033	171.10	0.365	-46.40	4.23
2400.00	0.267	-35.10	2.802	-49.40	0.034	160.80	0.346	-47.40	4.40
2500.00	0.262	-39.90	2.695	-66.00	0.036	148.30	0.331	-48.20	4.45
2600.00	0.253	-40.30	2.598	-82.30	0.036	134.80	0.321	-48.30	4.54
2700.00	0.253	-40.90	2.496	-98.60	0.034	121.40	0.311	-47.60	5.08
2800.00	0.248	-35.50	2.400	-114.60	0.036	106.50	0.299	-46.70	5.01
2900.00	0.237	-30.20	2.306	-130.20	0.032	92.80	0.279	-46.30	5.88
3000.00	0.230	-20.60	2.209	-146.60	0.031	83.60	0.254	-46.20	6.49

UPC2746TBV_{CC} = 3 V, I_{CC} = 7.7 mA

FREQUENCY (MHz)	S ₁₁		S ₂₁		S ₁₂		S ₂₂		K
	MAG	ANG	MAG	ANG	MAG	ANG	MAG	ANG	
100.00	0.146	165.00	6.443	-19.40	0.001	77.00	0.403	-5.30	108.63
200.00	0.130	141.70	6.594	-38.70	0.003	51.80	0.406	-8.60	20.56
300.00	0.117	117.90	6.623	-58.10	0.004	47.70	0.418	-11.10	16.33
400.00	0.128	100.80	6.522	-77.55	0.005	51.10	0.417	-14.00	12.34
500.00	0.139	90.80	6.613	-96.90	0.008	33.10	0.424	-16.20	8.14
600.00	0.145	83.10	6.481	-116.10	0.009	21.70	0.422	-19.40	7.22
700.00	0.135	77.00	6.424	-135.10	0.010	14.70	0.426	-23.80	6.52
800.00	0.131	67.40	6.353	-153.60	0.011	-0.40	0.433	-27.70	5.63
900.00	0.119	49.30	6.234	-172.10	0.014	-10.50	0.442	-32.10	4.80
1000.00	0.142	30.40	6.137	169.60	0.015	-24.20	0.455	-34.70	4.44
1100.00	0.170	18.10	5.992	151.10	0.016	-28.70	0.455	-37.50	4.02
1200.00	0.219	10.60	5.972	133.30	0.019	-48.00	0.453	-39.70	3.49
1300.00	0.245	7.40	5.867	115.10	0.019	-63.40	0.433	-42.70	3.40
1400.00	0.268	3.10	5.679	97.00	0.022	-72.20	0.409	-45.50	3.16
1500.00	0.270	1.50	5.582	79.10	0.021	-86.90	0.375	-48.30	3.38
1600.00	0.268	-3.90	5.380	61.80	0.022	-99.60	0.349	-49.90	3.36
1700.00	0.258	-7.80	5.122	44.50	0.024	-110.70	0.318	-50.00	3.42
1800.00	0.251	-14.30	4.880	27.90	0.024	-122.90	0.294	-49.20	3.67
1900.00	0.249	-16.70	4.634	11.70	0.025	-135.30	0.268	-45.40	3.73
2000.00	0.240	-20.50	4.475	-4.40	0.026	-146.00	0.248	-40.50	3.91

SYSTEM APPLICATION EXAMPLE

PCS

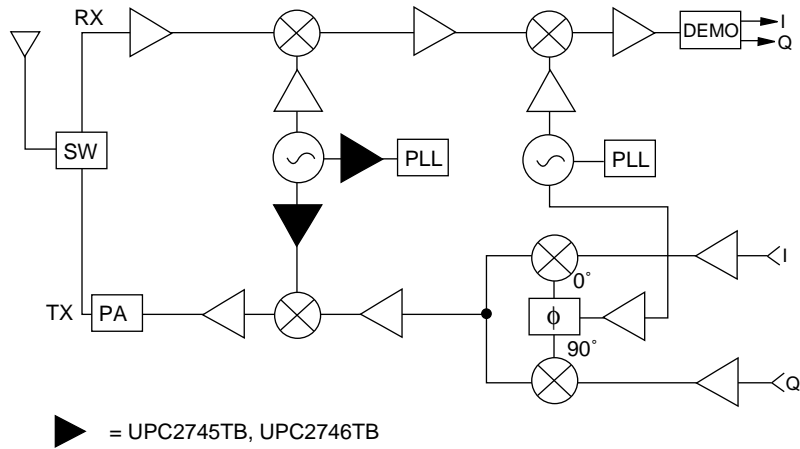

OUTLINE DIMENSIONS (Units in mm)

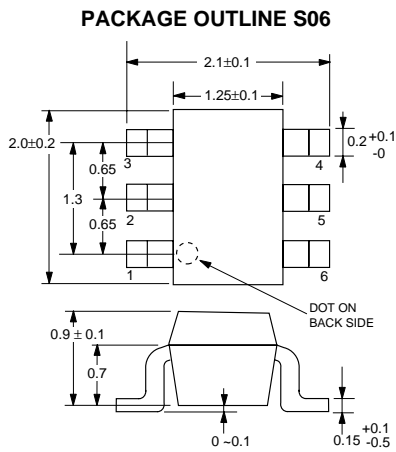

PIN CONNECTIONS

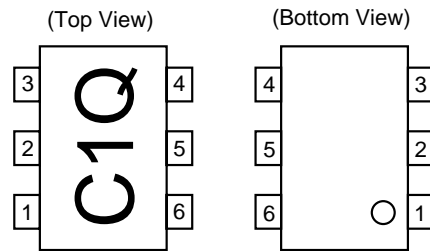

Marking is an example of UPC2745TB

- 1. Input 4. Output
- 2. GND 5. GND
- 3. GND 6. Vcc

TEST CIRCUIT

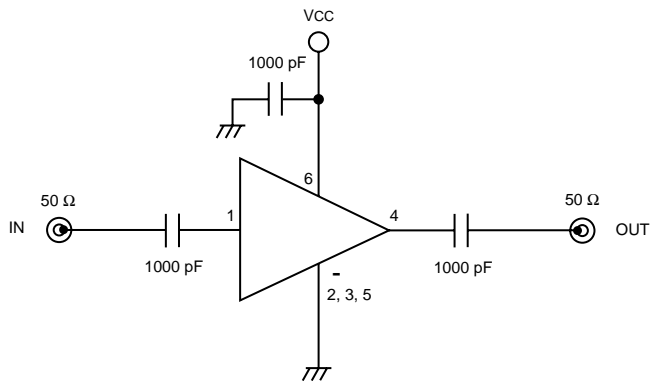

ORDERING INFORMATION

PART NUMBER	MARKING	QTY
UPC2745TB-E3	C1Q	3 K/reel
UPC2746TB-E3	C1R	3 K/reel

Note: Embossed tape, 8 mm wide. Pins 1, 2, and 3 face perforated side of tape.

EXCLUSIVE NORTH AMERICAN AGENT FOR **NEC** RF, MICROWAVE & OPTOELECTRONIC SEMICONDUCTORS

CEL CALIFORNIA EASTERN LABORATORIES • Headquarters • 4590 Patrick Henry Drive • Santa Clara, CA 95054-1817 • (408) 988-3500 • Telex 34-6393 • FAX (408) 988-0279
 24-Hour Fax-On-Demand: 800-390-3232 (U.S. and Canada only) • Internet: <http://WWW.CEL.COM>

DATA SUBJECT TO CHANGE WITHOUT NOTICE

PRINTED IN USA ON RECYCLED PAPER -12/97