

Complementary Silicon power transistors (15A / 60V / 115W)

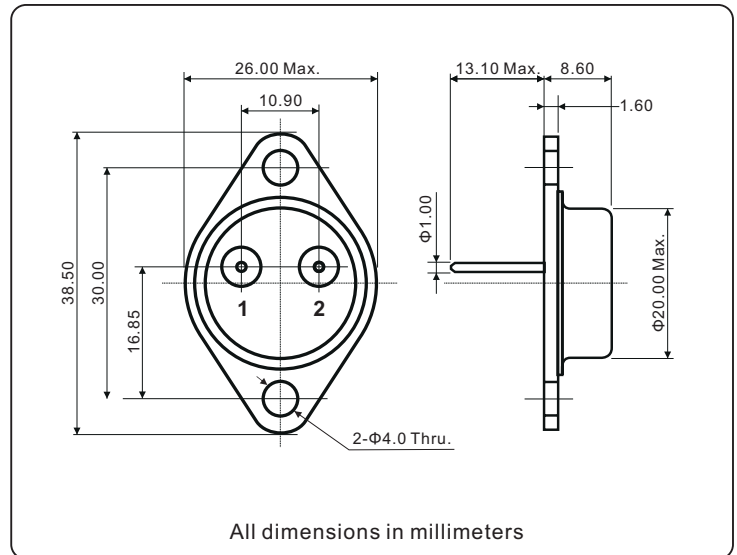
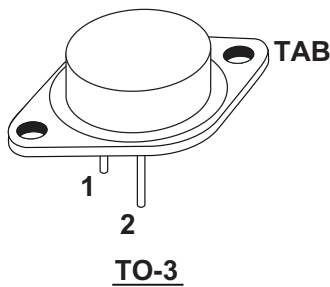

FEATURES

- Designed for general purpose switching and amplifier applications.
- DC current gain- $h_{FE} = 20-70 @ I_C = 4 \text{ Adc}$
- Collector-Emitter saturation voltage-
 $V_{CE(sat)} = 1.1 \text{ Vdc (Max) @ } I_C = 4 \text{ Adc}$
- Excellent safe operating area

DESCRIPTION

The 2N3055 is a silicon epitaxial-base planar NPN transistor mounted in JEDEC TO-3 metal case.

It is intended for power switching circuits, series and shunt regulators, output stages and fidelity amplifiers.

The complementary PNP type is MJ2955.

INTERNAL SCHEMATIC DIAGRAM

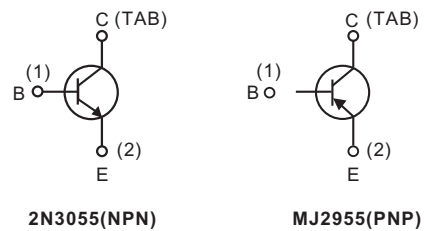

ABSOLUTE MAXIMUM RATINGS ($T_C = 25^\circ\text{C}$ unless otherwise specified)				
SYMBOL	PARAMETER		VALUE	UNIT
V_{CBO}	Collector to base voltage ($I_E = 0$)		100	V
V_{CER}	Collector to emitter voltage ($R_{BE} = 100\Omega$)		70	
V_{CEO}	Collector to emitter voltage ($I_B = 0$)		60	
V_{EBO}	Emitter to base voltage		7	
I_C	Collector current		15	A
I_B	Base current		7	
P_D	Total power dissipation	$T_C = 25^\circ\text{C}$	115	W
	Derate above 25°C		0.657	W/ $^\circ\text{C}$
T_j	Junction temperature		200	$^\circ\text{C}$
T_{stg}	Storage temperature		-65 to 200	

*For PNP types voltage and current values are negative.

THERMAL CHARACTERISTICS ($T_C = 25^\circ\text{C}$ unless otherwise specified)				
SYMBOL	PARAMETER		VALUE	UNIT
$R_{th(j-c)}$	Thermal resistance, junction to case		1.50	$^\circ\text{C/W}$

ELECTRICAL CHARACTERISTICS ($T_C = 25^\circ\text{C}$ unless otherwise specified)					
SYMBOL	PARAMETER	CONDITIONS	MIN	MAX	UNIT
I_{CEX}	Collector cutoff current	$V_{CE} = 100\text{V}, V_{BE} = -1.5\text{V}$		1.0	mA
		$V_{CE} = 100\text{V}, V_{BE} = -1.5\text{V}, T_C = 150^\circ\text{C}$		5.0	
I_{CEO}	Collector cutoff current	$V_{CE} = 30\text{V}, I_B = 0$		0.7	mA
I_{EBO}	Emitter cutoff current	$V_{EBO} = 7\text{V}, I_C = 0$		5.0	
$V_{CEO(SUS)}^*$	Collector to emitter sustaining voltage	$I_C = 200\text{mA}, I_B = 0$	60		V
$V_{CER(SUS)}^*$	Collector to emitter sustaining voltage	$I_C = 200\text{mA}, R_{BE} = 100\Omega$	70		
V_{CBO}	Collector to base voltage	$I_E = 0$	100		
V_{EBO}	Emitter to base voltage	$I_C = 0$	7		
h_{FE}	Forward current transfer ratio (DC current gain)	$I_C = 4\text{A}, V_{CE} = 4\text{V}$	20	70	
		$I_C = 10\text{A}, V_{CE} = 4\text{V}$	5		
$V_{CE(sat)}^*$	Collector to emitter saturation voltage	$I_C = 4\text{A}, I_B = 400\text{mA}$		1.1	V
		$I_C = 10\text{A}, I_B = 3.3\text{A}$		3.0	
$V_{BE(on)}^*$	Base to emitter on voltage	$V_{CE} = 4\text{V}$		1.5	
f_T	Transition frequency	$I_C = 0.5\text{A}, V_{CE} = 10\text{V}, f = 1.0\text{MHz}$	2.5		MHz
$I_{s/b}^*$	Second breakdown collector current with base forward biased	$V_{CE} = 40\text{V}, t = 1.0\text{s}$	2.87		A

*Pulsed : Pulse duration = 300 μs , duty cycle 1.5%.

*For PNP types voltage and current values are negative.

Fig.1 Power derating

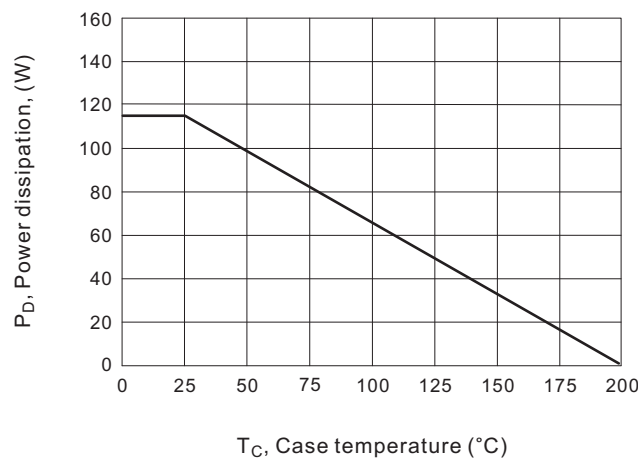
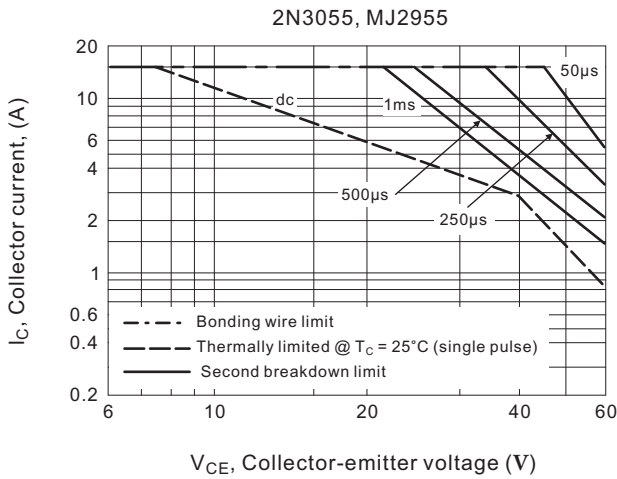

Fig.2 Active region safe operating area



There are two limitations on the power handling ability of a transistor: average junction temperature and second breakdown. Safe operating area curves indicate I_C - V_{CE} limits of the transistor that must be observed for reliable operation; i.e., the transistor must not be subjected to greater dissipation than the curves indicate.

The data of fig.2 is based on $T_C = 25^\circ\text{C}$; $T_{J(pk)}$ is variable depending on power level. Second breakdown pulse limits are valid for duty cycles to 10% but must be derated for temperature according to fig.1

Fig.3 DC Current gain

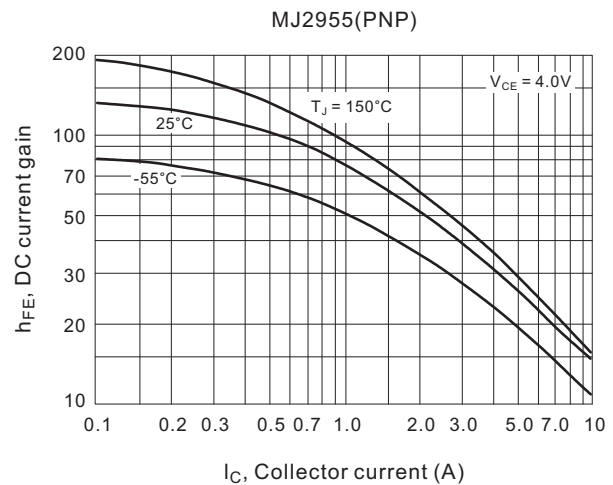
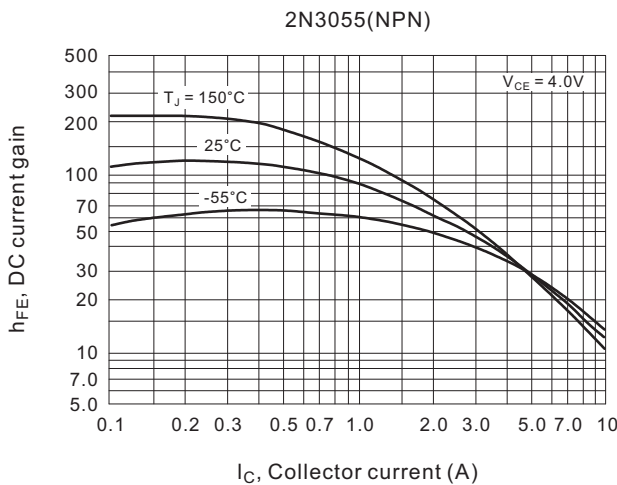

Fig.4 Collector saturation region

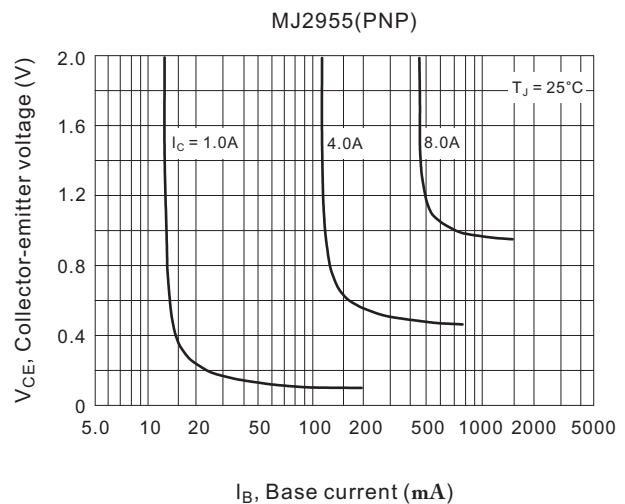
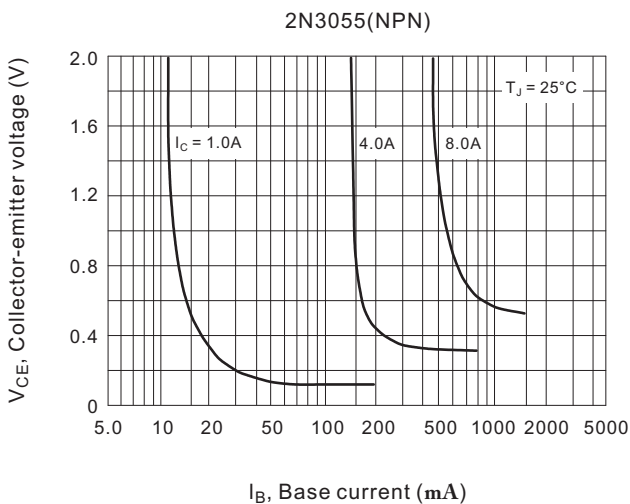

Fig.5 "On" Voltages

