

**Panasonic**  
 ideas for life

Miniature DIL SSR  
 1A control type for PCBs

**AQ-C RELAYS**

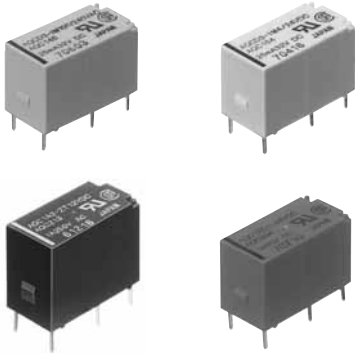

RoHS compliant

### FEATURES

1. Compact DIL type:  
L20 mm × W10 mm × H12.8 mm  
(.787×.394×.504 inch)
2. Excellent in noise resistance
3. Snubber circuit integrated
4. High dielectric strength: 2,500 V between input and output
5. Reverse polarity type available

### TYPICAL APPLICATIONS

1. Compact AC motor, Solenoid, Magnet, Driver of magnetic valve
2. Copying equipment
3. NC machine, Robot
4. Programmable controller
5. Air conditioners

### ORDERING INFORMATION

AQC  -  -  -  -

Load current  
 Nil: Input module  
 1A: Output module

Load voltage  
 1: 75 to 125 V AC (Output module)  
 2: 75 to 250 V AC (Output module)  
 D1: 3 to 60 V DC (Output module)  
 D3: 4 to 32 V DC (Input module)

Type  
 Nil: DC output  
 IM: Input module  
 T: AC output Random  
 ZT: AC output Zero-cross

Input voltage  
 Output module: 5, 12, 24 V DC  
 Input module: 4/24 V DC, 100/240 V AC

Input polarity  
 Nil: Standard polarity  
 R: Reverse polarity (Only for output module)

### TYPES

#### 1. Input module

Type	Output voltage	Input voltage	Part No.
AC input	4 to 32 V DC	80 to 250 V AC	AQCD3-IM 100/240 V AC
DC input	4 to 32 V DC	3 to 32 V DC	AQCD3-IM 4/24 V DC

Standard packing: Carton: 50 pcs.; Case: 500 pcs.

# AQ-C

## 2. Output module

Type	Load voltage	Input voltage	Part No.
AC output Zero-cross	75 to 125 V AC	5 V DC	AQC1A1 - ZT5 V DC
		12 V DC	AQC1A1 - ZT12 V DC
		24 V DC	AQC1A1 - ZT24 V DC
	75 to 250 V AC	5 V DC	AQC1A2 - ZT5 V DC
		12 V DC	AQC1A2 - ZT12 V DC
		24 V DC	AQC1A2 - ZT24 V DC
AC output Random	75 to 125 V AC	5 V DC	AQC1A1 - T 5 V DC
		12 V DC	AQC1A1 - T 12 V DC
		24 V DC	AQC1A1 - T 24 V DC
	75 to 250 V AC	5 V DC	AQC1A2 - T 5 V DC
		12 V DC	AQC1A2 - T 12 V DC
		24 V DC	AQC1A2 - T 24 V DC
DC output	3 to 60 V DC	5 V DC	AQC1AD1- 5 V DC
		12 V DC	AQC1AD1- 12 V DC
		24 V DC	AQC1AD1- 24 V DC

Standard packing: Carton: 50 pcs.; Case: 500 pcs.

Note: Reverse polarity type (AQC5\*\* and AQC6\*\*) is also produced by lot after receipt of order.

## RATING

1. Rating [Ambient temperature: 20°C 68°F; Input voltage ripple (output module) and output voltage ripple (input module): 1% or less]

### 1) Input module

Item	Type	AC input	DC input	Remarks
		AQCD3-IM 100/240 V AC	AQCD3-IM 4/24 V DC	
Input side	Input voltage	80 to 250 V AC	3 to 32 V DC	
	Input current	Max. 5 mA	Max. 5 mA	
	Pick-up voltage	Max. 80 V AC	Max. 3 V DC	
	Drop-out voltage	Min. 10 V AC	Min. 1 V DC	
Output side	Load voltage	4 to 32 V DC	4 to 32 V DC	
	Load current	0.1 to 25 mA	0.1 to 25 mA	
	Max. "OFF-state" leakage current	Max. 5μA	Max. 5μA	When 32 V DC applied
	Max. "ON-state" voltage drop	Max. 1.6 V	Max. 1.6 V	at max. carrying current

### 2) Output module

#### (1) AC output type

Item	Type	AQC1A1-ZT5VDC	AQC1A1-T12VDC	AQC1A1-ZT24VDC	AQC1A2-ZT5VDC	AQC1A2-ZT12VDC	AQC1A2-ZT24VDC	Remarks
		AQC1A1-T5VDC	AQC1A1-T12VDC	AQC1A1-T24VDC	AQC1A2-T5VDC	AQC1A2-T12VDC	AQC1A2-T24VDC	
Input side	Input voltage	(5 V type) 4 to 6 V DC	(12 V type) 9.6 to 14.4 V DC	(24 V type) 21.6 to 26.4 V DC	(5 V type) 4 to 6 V DC	(12 V type) 9.6 to 14.4 V DC	(24 V type) 21.6 to 26.4 V DC	*1
	Input impedance (Approx.)	0.3 kΩ	0.8 kΩ	1.8 kΩ	0.3 kΩ	0.8 kΩ	1.8 kΩ	
	Drop-out voltage, min	0.5 V	1.2 V	2.4 V	0.5 V	1.2 V	2.4 V	
Load side	Max. load current	1 A*2						Ta = Max. 40°C 104°F
	Load voltage	75 to 125 V AC			75 to 250 V AC			
	Non-repetitive surge current	20 A*3						In one cycle at 60 Hz
	Max. "OFF-state" leakage current	0.6 m A (When 100 V AC applied)			1.1 m A (When 200 V AC applied)			at 60 Hz
	Max. "ON-state" voltage drop	1.6 V						at max. carrying current
	Min. load current	10 mA*4			20 mA*4			

#### (2) DC output type

Item	Type	AQC1AD1-5VDC	AQC1AD1-12VDC	AQC1AD1-24VDC	Remarks
		AQC1AD1-5VDC	AQC1AD1-12VDC	AQC1AD1-24VDC	
Input side	Input voltage	(5 V type) 4 to 6 V DC	(12 V type) 9.6 to 14.4 V DC	(24 V type) 21.6 to 26.4 V DC	*1
	Input impedance (Approx.)	0.43 kΩ	1.2 kΩ	2.8 kΩ	
	Drop-out voltage, min	0.8 V			
Load side	Max. load current	1 A*2			Ta = Max. 40°C 104°F
	Load voltage	3 to 60 V DC			
	Non-repetitive surge current	1.5 A*3			at 1 s
	Max. "OFF-state" leakage current	0.1 m A (When 60 V DC applied)			
	Max. "ON-state" voltage drop	1.6 V			at max. carrying current
	Min. load current	1 mA*4			

Notes: \*1. Refer to REFERENCE DATA "3. Input current vs. input voltage characteristics".

\*2. Refer to REFERENCE DATA "1. Load current vs. ambient temperature".

\*3. Refer to REFERENCE DATA "2. Non-repetitive surge current vs. carrying time".

\*4. When the load current is less than the rated minimum load current, please refer to "Cautions for Use of SSR".

**2. Characteristics**

[Ambient temperature: 20°C 68°F; Input voltage ripple (output module) and output voltage ripple (input module): 1% or less]

1) Input module

Item	Type	AC Input module	DC Input module	Remarks
Operate time, max.		20 ms	0.5 ms	Input voltage: 24 V DC or 100V AC Output voltage: 24 V DC Output current: 25mA
Release time, max		20 ms	0.5 ms	
Insulation resistance, min.		10 <sup>9</sup> Ω between input and output		at 500 V DC
Breakdown voltage		2,500 Vrms between input and output		For 1 minute
Vibration resistance	Destructive	10 to 55Hz double amplitude of 3 mm		1 hour for X, Y, Z, axis
	Functional	10 to 55Hz double amplitude of 3 mm		10 minutes for X, Y, Z, axis
Shock resistance	Destructive	Min. 980 m/s <sup>2</sup> {100 G}		5 time each for X, Y, Z axis
	Functional	Min. 980 m/s <sup>2</sup> {100 G}		4 time each for X, Y, Z axis
Ambient temperature		-30°C to +80°C -22°F to +176°F		
Storage temperature		-30°C to +100°C -22°F to +212°F		

2) Output module

Item	Type	AC output		DC output	Remarks
		Random	Zero-cross		
Operate time, max.		1 ms	1/2 cycle of voltage sine wave + 1ms	0.5 ms	
Release time, max.		1/2 cycle of voltage sine wave + 1ms		1 ms	
Insulation resistance, min.		10 <sup>9</sup> Ω between input and output			at 500 V DC
Breakdown voltage		2,500 Vrms between input and output			For 1 minute
Vibration resistance	Destructive	10 to 55Hz double amplitude of 3 mm			1 hour for X, Y, Z, axis
	Functional	10 to 55Hz double amplitude of 3 mm			10 minutes for X, Y, Z, axis
Shock resistance	Destructive	Min. 980 m/s <sup>2</sup> {100 G}			5 time each for X, Y, Z axis
	Functional	Min. 980 m/s <sup>2</sup> {100 G}			4 time each for X, Y, Z axis
Ambient temperature		-30°C to +80°C -22°F to +176°F			
Storage temperature		-30°C to +100°C -22°F to +212°F			
Operational method		Random Turn-ON, Zero-cross (Turn-OFF)	Zero-cross (Turn-ON and Turn-OFF)	—	

**REFERENCE DATA**

1. Load current vs. ambient temperature characteristics (AC/DC output)

Use load current within range specified in the figure below

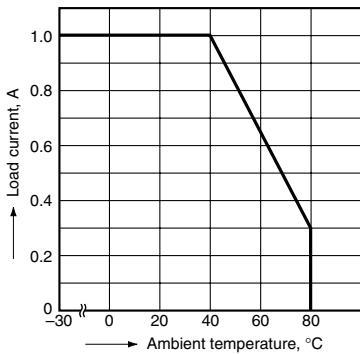

2.-(1) Non-repetitive surge current vs. carrying time characteristics (AC output)

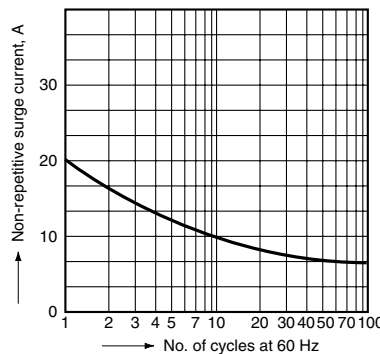

2.-(2) Non-repetitive surge current vs. carrying time characteristics (DC output)

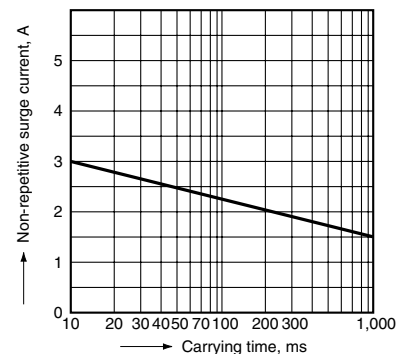

3. Input current vs. input voltage characteristics (AC/DC output)

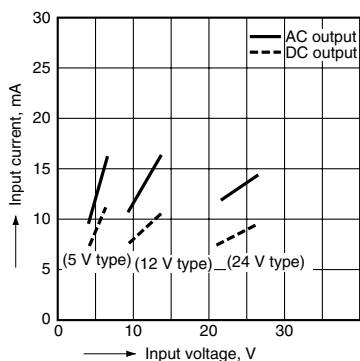

4.-(1) Input current vs. input voltage characteristics (AC input)

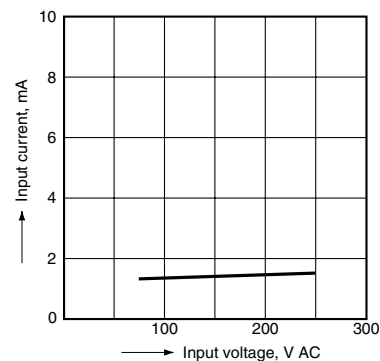

4.-(2) Input current vs. input voltage characteristics (DC input)

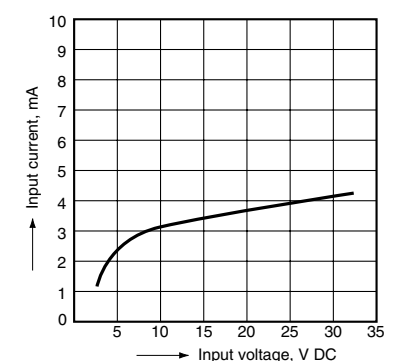

# AQ-C

## 5. Load current vs. ambient temperature characteristics for adjacent mounting (AC/DC output)

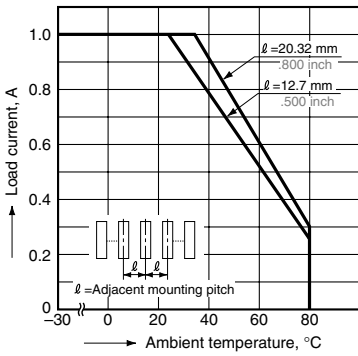

## DIMENSIONS (mm inch)

The CAD data of the products with a **CAD Data** mark can be downloaded from: <http://industrial.panasonic.com/ac/e/>

### 1. Input module (AC, DC)

**CAD Data**

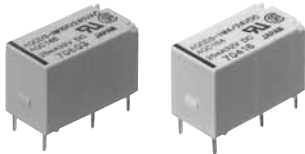

#### External dimensions

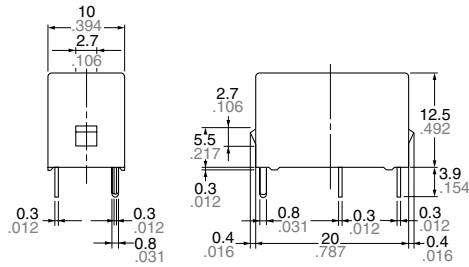

AC input  
 ⑤... Output: DC-  
 ⑧... Output: DC+  
 ⑯... Input: AC  
 ①... Input: AC  
 Case color: Yellow

DC input  
 ⑤... Output: DC-  
 ⑧... Output: DC+  
 ⑯... Input: DC+  
 ①... Input: DC-  
 Case color: White

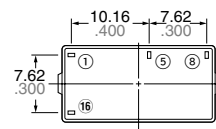

General tolerance:  $\pm 0.5 \pm 0.20$

#### PC board pattern (Copper-side view)

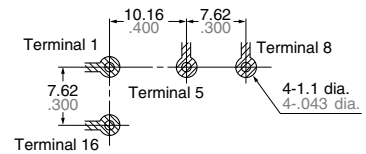

Tolerance:  $\pm 0.1 \pm 0.04$

#### Schematic

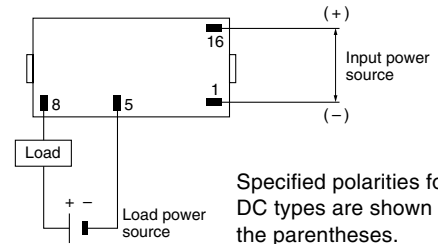

Specified polarities for DC types are shown in the parentheses.

### 2. Output module (AC, DC)

**CAD Data**

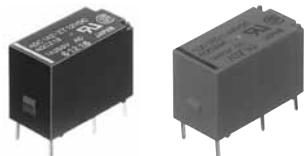

#### External dimensions

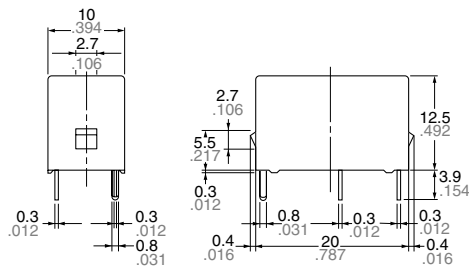

AC output  
 ⑤... Output: AC  
 ⑧... Output: AC  
 ⑯... Input: DC+  
 ①... Input: DC-  
 Case color: Black

DC output  
 ⑤... Output: DC-  
 ⑧... Output: DC+  
 ⑯... Input: DC+  
 ①... Input: DC-  
 Case color: Red

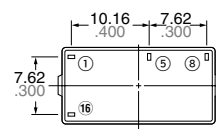

General tolerance:  $\pm 0.5 \pm 0.20$

#### PC board pattern (Copper-side view)

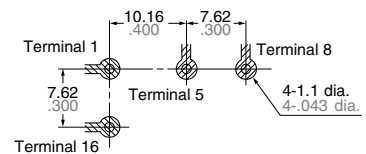

Tolerance:  $\pm 0.1 \pm 0.04$

#### Schematic

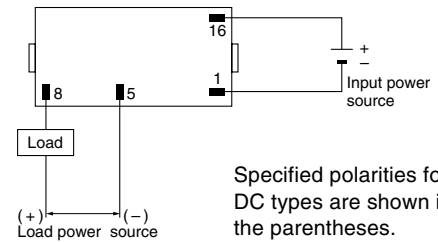

Specified polarities for DC types are shown in the parentheses.

## ACCESSORY

### Socket



PC1A-PS

## NOTES

### When used for the load less than rated

In the case of the load current less than rated, malfunction may result from the residual voltage across the both ends of the load even if the solid state relay is turned off.

Use a dummy resistor as a countermeasure.

The total of the current through the resistor and the load current must exceed the min. rated load current.

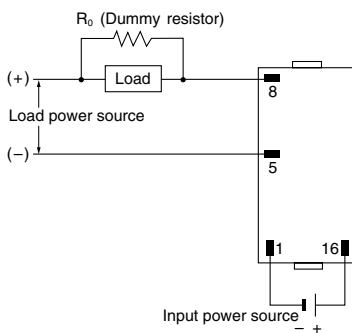

In case the dummy resistor is not used, keep in mind that the residual voltage becomes as follows:

Example:

For the inductive load by the 5 mA load current and the 200 V AC load voltage, the load impedance becomes 40 kΩ and  $V_e/V = 16\%$  is estimated from the below graph.

Accordingly, the 32 V voltage remains across the both ends of the load when the solid state relay is turned off.

### • Characteristics of residual voltage vs. load impedance (AC output)

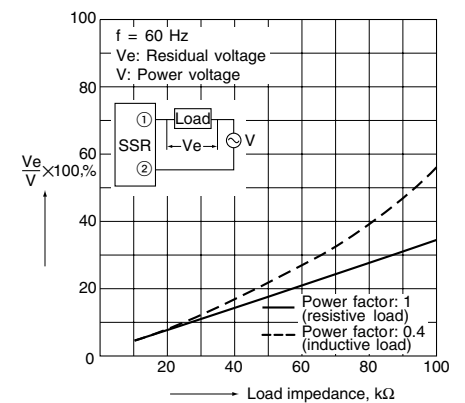

## For Cautions for Use.