



3
GENERAL PURPOSE
AMPLIFIERS (LNAs,
HPAs, LINEAR AMPS)

Features

- 6W Output Power
- High Linearity
- 45% Power-Added Efficiency
- Thermally-Enhanced AIN Packaging
- 150MHz to 960MHz Operation
- 5V to 8V Supply with Adjustable Bias

Applications

- Driver for 450MHz and 850MHz Basestation Amplifiers
- PA Stage for Commercial Wireless Infrastructure

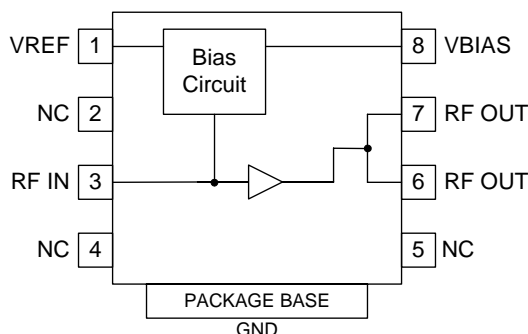

Functional Block Diagram

Product Description

The RF3800 is specifically designed for wireless infrastructure applications at 450MHz and 850MHz. Using a highly reliable GaAs HBT fabrication process, this high-performance single-stage amplifier achieves high output power over a broad frequency range. The RF3800 also provides excellent efficiency and thermal stability through the use of a thermally-enhanced surface-mount AIN package. Ease of integration is accomplished through the incorporation of an optimized evaluation board design provided to achieve proper 50Ω operation. Various evaluation board configurations are available to address a broad range of wireless infrastructure applications.

Ordering Information

RF3800	GaAs HBT Pre-Driver Amplifier
RF3800PCBA-416	Fully Assembled Evaluation Board

Optimum Technology Matching® Applied

- | | | | |
|--|--------------------------------------|-------------------------------------|-----------------------------------|
| <input checked="" type="checkbox"/> GaAs HBT | <input type="checkbox"/> SiGe BiCMOS | <input type="checkbox"/> GaAs pHEMT | <input type="checkbox"/> GaN HEMT |
| <input type="checkbox"/> GaAs MESFET | <input type="checkbox"/> Si BiCMOS | <input type="checkbox"/> Si CMOS | |
| <input type="checkbox"/> InGaP HBT | <input type="checkbox"/> SiGe HBT | <input type="checkbox"/> Si BJT | |

RF MICRO DEVICES®, RFMD®, Optimum Technology Matching®, Enabling Wireless Connectivity™, PowerStar®, POLARIS™ TOTAL RADIO™ and UltimateBlue™ are trademarks of RFMD, LLC. BLUETOOTH is a trademark owned by Bluetooth SIG, Inc., U.S.A. and licensed for use by RFMD. All other trade names, trademarks and registered trademarks are the property of their respective owners. ©2006, RF Micro Devices, Inc.

Absolute Maximum Ratings

Parameter	Rating	Unit
Supply Voltage (V_{CC})	9.0	V_{PC}
DC Supply Current	2300	mA
Input RF Power	29	dBm
Output Load VSWR	7:1	
Operating Ambient Temperature	85	$^{\circ}C$
Storage Temperature	+125	$^{\circ}C$



Caution! ESD sensitive device.

The information in this publication is believed to be accurate and reliable. However, no responsibility is assumed by RF Micro Devices, Inc. ("RFMD") for its use, nor for any infringement of patents, or other rights of third parties, resulting from its use. No license is granted by implication or otherwise under any patent or patent rights of RFMD. RFMD reserves the right to change component circuitry, recommended application circuitry and specifications at any time without prior notice.

RoHS status based on EU Directive 2002/95/EC (at time of this document revision).

Parameter	Specification			Unit	Condition
	Min.	Typ.	Max.		
Overall - 450MHz					$I_{REF} = 16\text{ mA}$, $V_{CC} = V_{BIAS} = V_{REF} = 8\text{ V}$, Temp = +25 $^{\circ}C$
Frequency	450		470	MHz	
Output P1dB	37.0	38.0	39.1	dBm	
Power Added Efficiency		45		%	@ P1dB
		52		%	@ P_{SAT}
Small Signal Gain	14.0	14.7		dB	
Input Return Loss	15	20		dB	
Output Return Loss	8	12		dB	
OIP3		41		dBm	23 dBm/tone
		44		dBm	26 dBm/tone
		45		dBm	28 dBm/tone
	46	51		dBm	30 dBm/tone
		51		dBm	31 dBm/tone
		50		dBm	32 dBm/tone
Noise Figure		6.5		dB	
Second Harmonic		-35		dBc	@ P1dB
Third Harmonic		-50		dBc	@ P1dB
Overall - 850MHz					$I_{REF} = 35\text{ mA}$, $V_{CC} = V_{BIAS} = V_{REF} = 8\text{ V}$, Temp = +25 $^{\circ}C$
Frequency	869		894	MHz	
Output P1dB		37.0		dBm	
Power Added Efficiency		42.5		%	
Small Signal Gain		12		dB	
Input Return Loss	-11	-15		dB	
Output Return Loss	-10	-10		dB	
OIP3		48		dBm	23 dBm/tone
Second Harmonic		-60		dBc	@ P1dB
Third Harmonic		-60		dBc	@ P1dB
Power Control					
V_{REF}		8.0		V	To set I_{REF} at 16 mA
Power Control "OFF"	0	0	0.5	V	
Power Supply					
Power Supply Voltage	7	8	9	V	
Supply Current	300	400	500	mA	$V_{REF} = 8\text{ V}$, $I_{REF} = 16\text{ mA}$
Power Down Current			10	μA	$V_{REF} = 0\text{ V}$, $V_{CC} = 8\text{ V}$

Pin	Function	Description
1	VREF	Control for active bias. Set to 8V at board jack. Drops to ~3.2V at pin.
2	NC	Not connected.
3	RF IN	RF input. Requires RF match and DC block.
4	NC	Not connected.
5	NC	Not connected.
6	RF OUT	RF output. Requires RF match, bias feed and DC block.
7	RF OUT	See pin 6.
8	VBIAS	Supply for active bias. Set to 8V.
Pkg Base	GND	Backside of package should be connected to a short path to ground.

Package Drawing

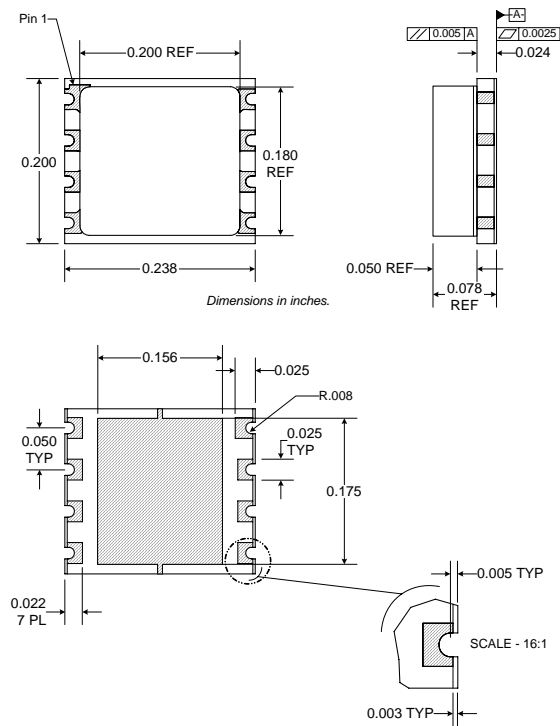

3
GENERAL PURPOSE
AMPLIFIERS (LNAs,
HPAs, LINEAR AMPS)

Application Schematic - 220 MHz

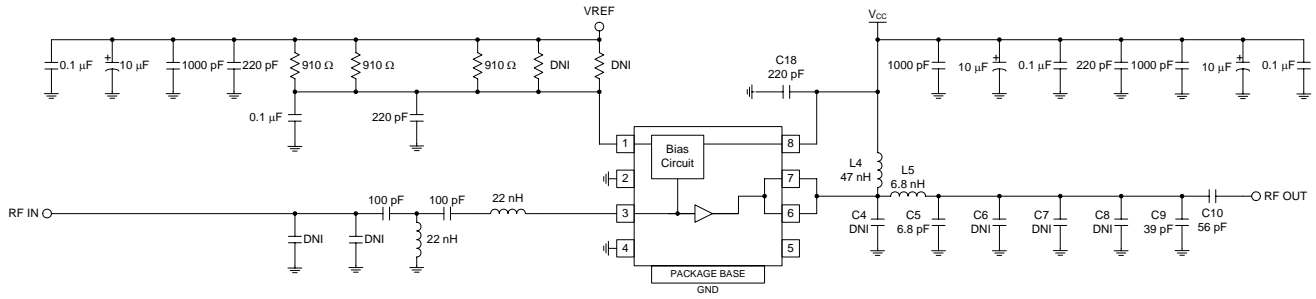

Application Schematic - 570 MHz to 610 MHz

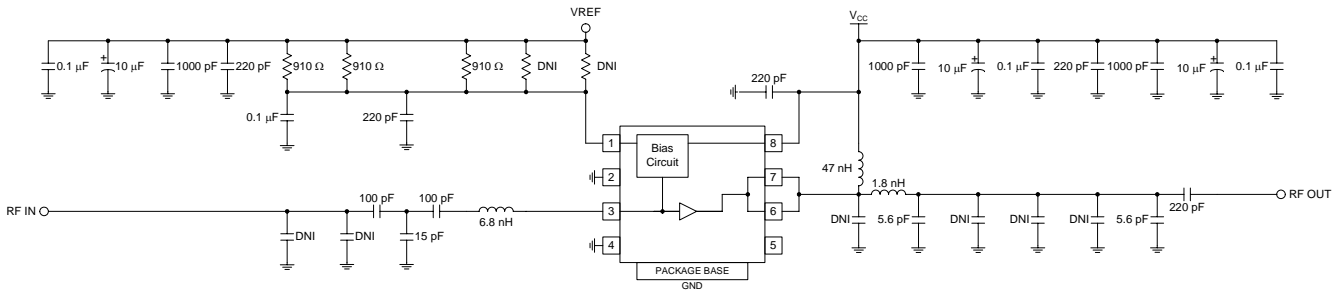

Application Schematic - 680 MHz

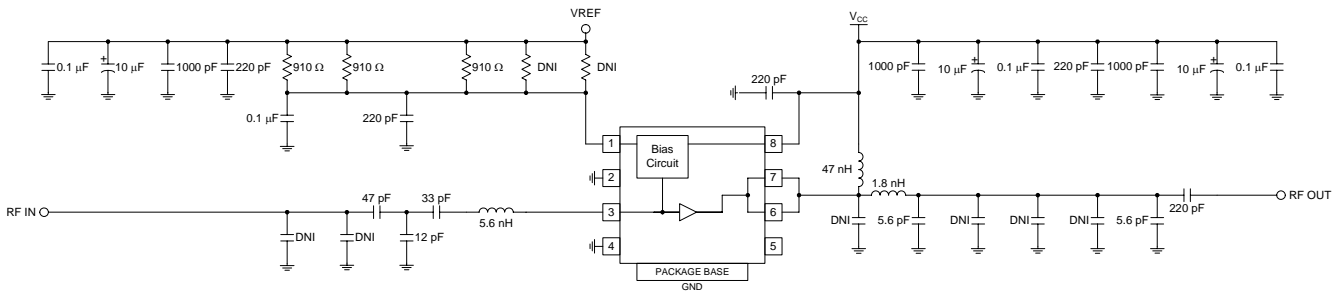

Application Schematic - 880 MHz

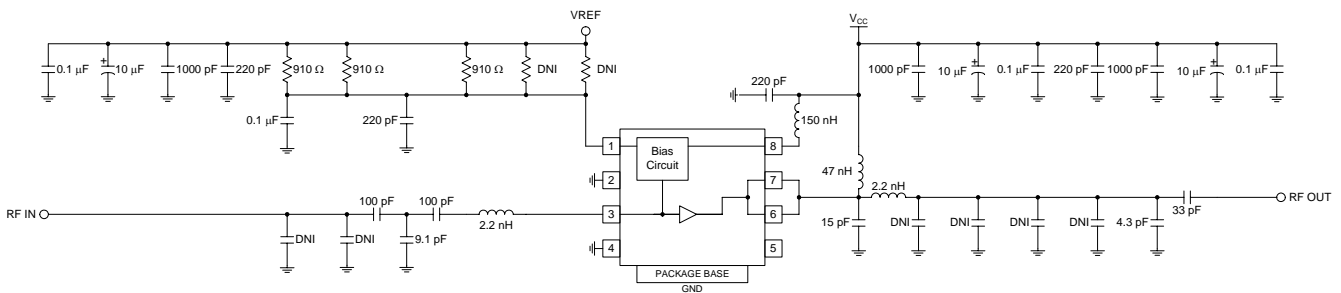

Application Schematic - 945 MHz

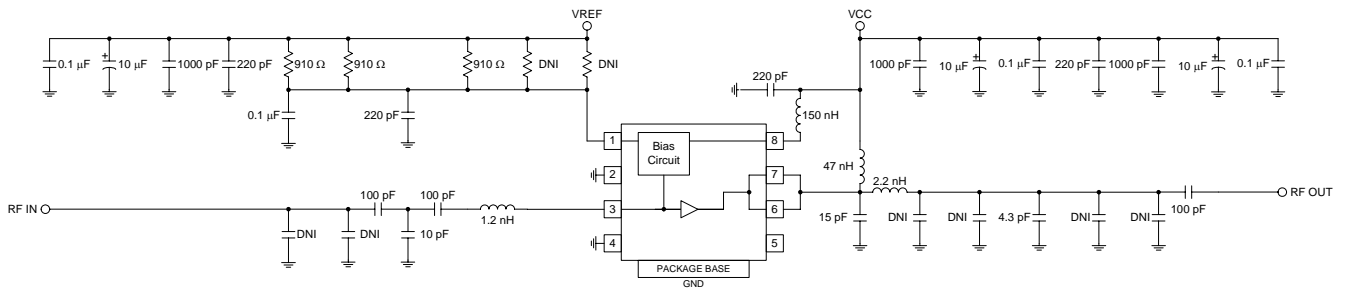

3
**GENERAL PURPOSE
 AMPLIFIERS (LNAs,
 HPAs, LINEAR AMPS)**

Evaluation Board Schematic - 450 MHz

3
GENERAL PURPOSE
AMPLIFIERS (LNAs,
HPAs, LINEAR AMPS)

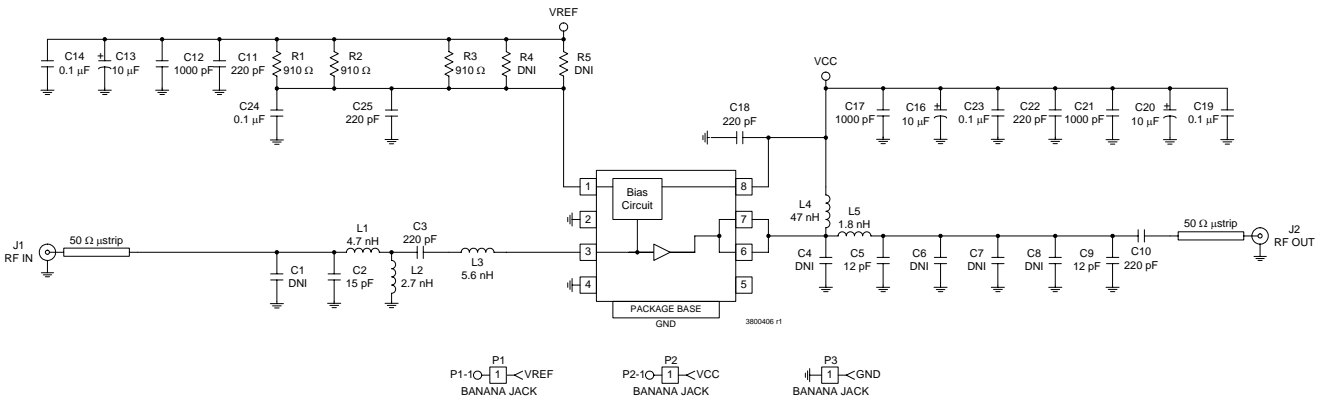

RF3800 Biasing Table

The resistor values shown below are for varied V_{CC}/I_{CQ} conditions. Biasing for higher quiescent current will give increased linearity. "R_Bias" = equivalent R in line with V_{REF} (see values on evaluation board schematic: R1, R2, R3).

V_{CC} (V)	V_{REF} (V)	R_Bias (Ω)	I_{REF} (mA)	I_{CQ} (mA)
8	8	300	16	400
8	8	170	25	563
8	8	105	35	632
8	8	72	45	684
5	5	110	16	372
5	5	48	25	493
5	5	21	35	574
5	5	4.9	45	629

Evaluation Board Layout
Board Size 2.0" x 2.0"
Board Thickness 0.02", Board Material Rogers 4350

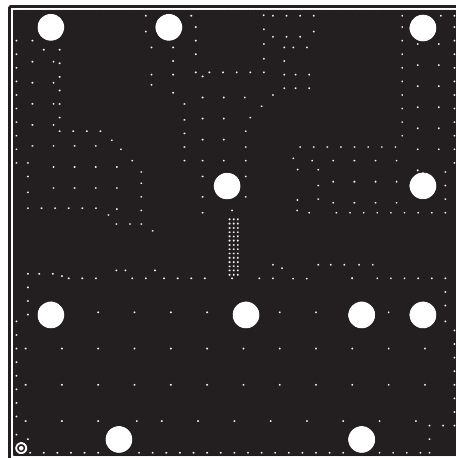
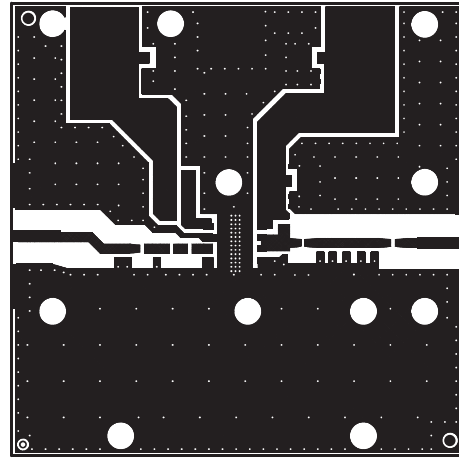
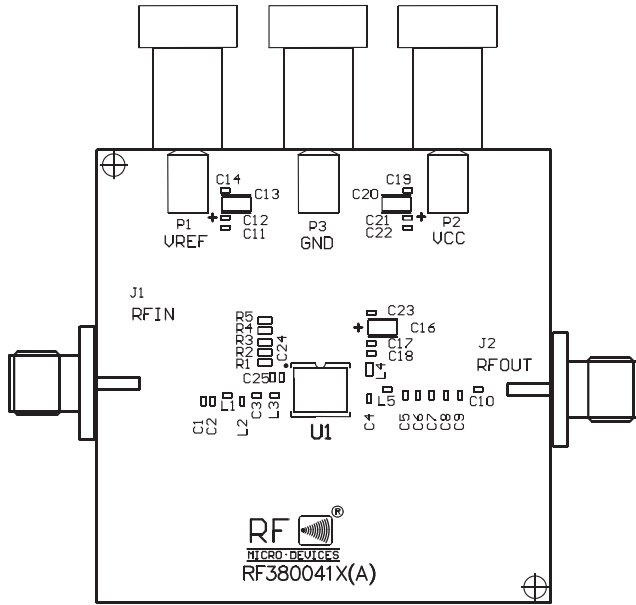

3
GENERAL PURPOSE
AMPLIFIERS (LNAs,
HPAs, LINEAR AMPS)

GENERAL PURPOSE
AMPLIFIERS (LNAs,
HPAs, LINEAR AMPs)

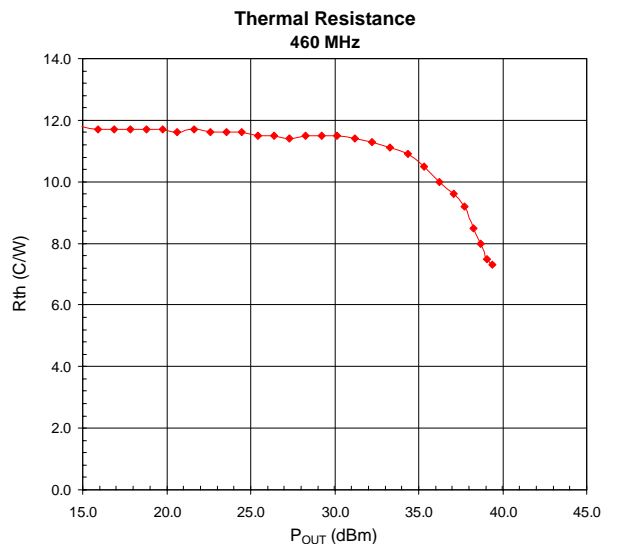
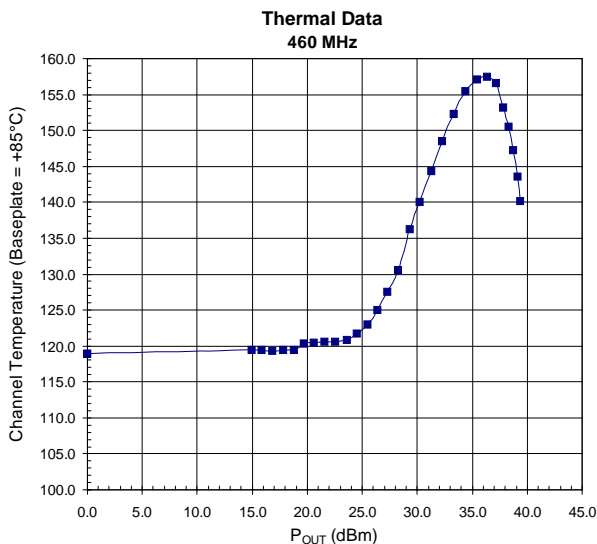
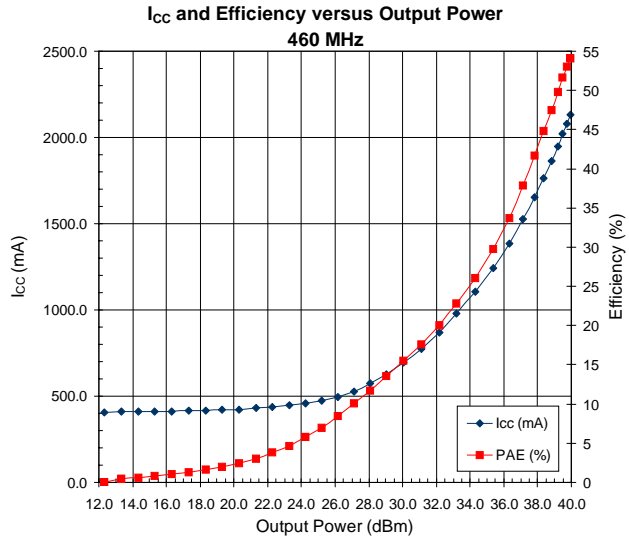
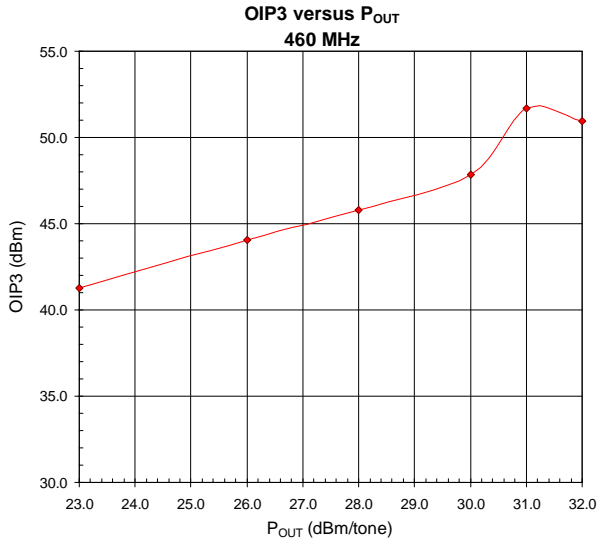
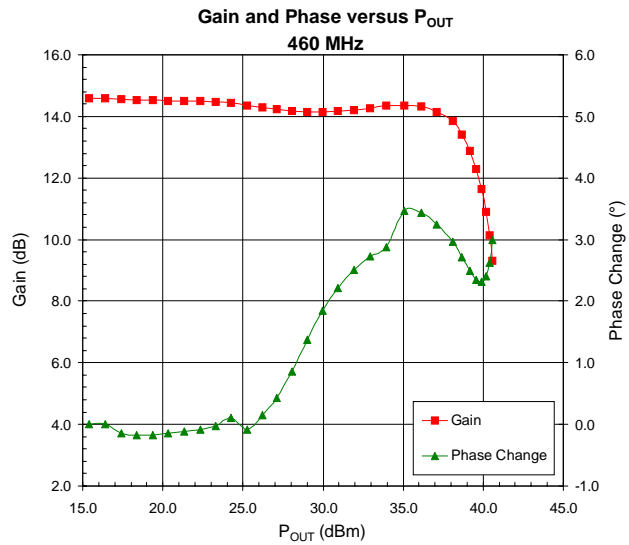
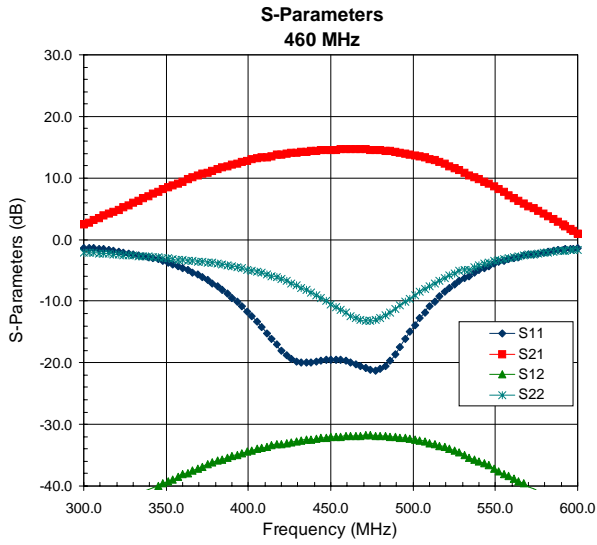

**P1dB and Gain versus Frequency
460 MHz**

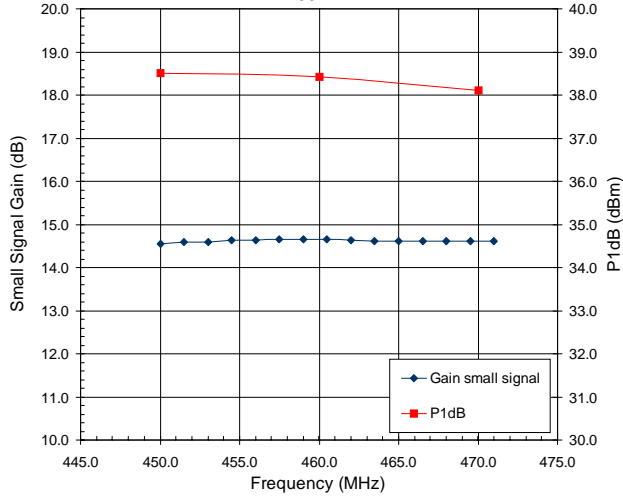

**EDGE EVM
460 MHz**

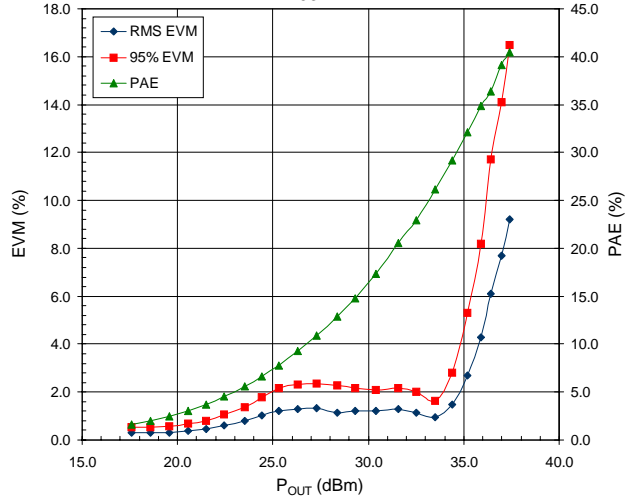

**CDMA2000 Performance
460 MHz**

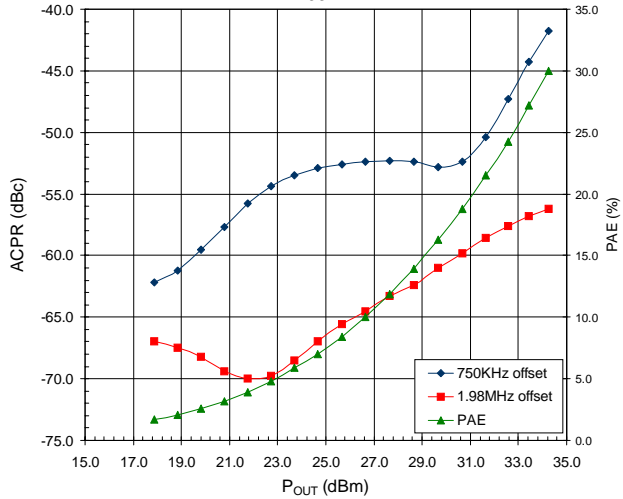

3
GENERAL PURPOSE
AMPLIFIERS (LNAs,
HPAs, LINEAR AMPS)

PCB Design Requirements

PCB Surface Finish

The PCB surface finish used for RFMD's qualification process is electroless nickel, immersion gold. Typical thickness is 3µinch to 8µinch gold over 180µinch nickel.

PCB Land Pattern Recommendation

PCB land patterns for PFMD components are based on IPC-7351 standards and RFMD empirical data. The pad pattern shown has been developed and tested for optimized assembly at RFMD. The PCB land pattern has been developed to accommodate lead and package tolerances. Since surface mount processes vary from company to company, careful process development is recommended.

PCB Metal Land Pattern

- A = 1.14 x 0.71
- B = 1.02 x 0.71 Typ.
- C = 3.96 x 4.44

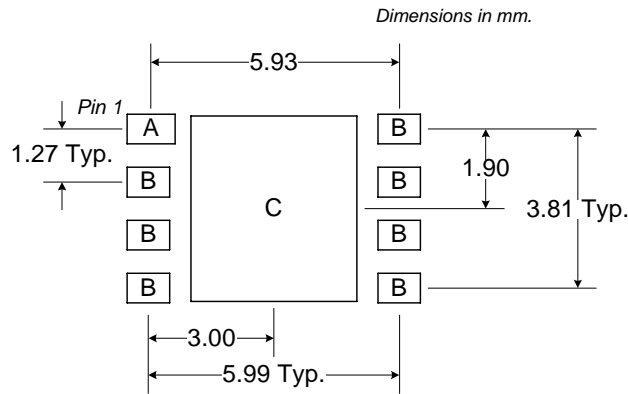

PCB Solder Mask Pattern

Liquid Photo-Imageable (LPI) solder mask is recommended. The solder mask footprint will match what is shown for the PCB metal land pattern with a 2mil to 3mil expansion to accommodate solder mask registration clearance around all pads. The center-grounding pad shall also have a solder mask clearance. Expansion of the pads to create solder mask clearance can be provided in the master data or requested from the PCB fabrication supplier.

- A = 1.30 x 0.86
- B = 1.17 x 0.86 Typ.
- C = 4.11 x 4.60

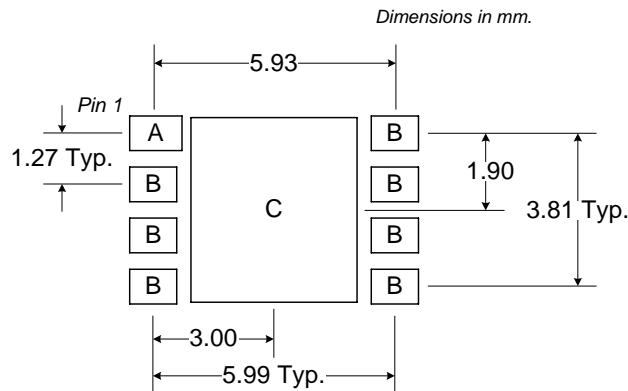

Thermal Pad and Via Design

The DUT must be connected to the PCB backside ground through a low inductance, low thermal resistance path. The required interface is achieved with the via pattern shown below for both low inductance as well as low thermal resistance. The footprint provided below worked well on the RFMD 20mil thick Rogers 4350 PCB and also standard FR4. The vias are 8mil vias that are partially plated through and are finished to 8mils±2mils with a minimum plating of 1.5mil. Failure to place these vias within the DUT mounting area on the PCB in this prescribed manner may result in electrical performance and/or reliability degradation.

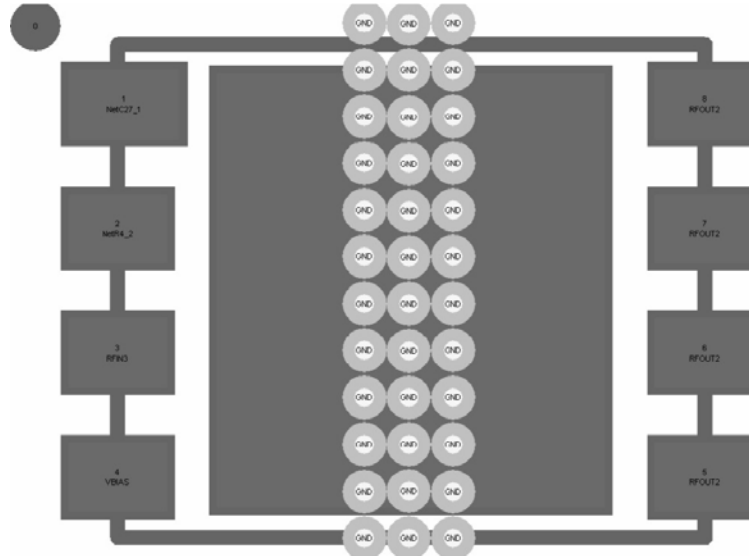

3
**GENERAL PURPOSE
 AMPLIFIERS (LNAs,
 HPAs, LINEAR AMPS)**

Tape and Reel Information

Carrier tape basic dimensions are based on EIA481. The pocket is designed to hold the part for shipping and loading onto SMT manufacturing equipment, while protecting the board and the solder terminals from damaging stresses. The individual pocket design can vary from vendor to vendor, but wide and pitch will be consistent.

Carrier tape is wound or placed on a shipping reel with a diameter of either 330mm (13 inches) or 178mm (7 inches). The center hub design is large enough to ensure the radius formed by the carrier tape around it does not put unnecessary stress on the parts.

Prior to shipping, moisture sensitive parts (MSL level 2a to 5a) are baked and placed into the pockets of the carrier tape. A cover tape is sealed over the top of the entire length of the carrier tape. The reel is sealed in a moisture barrier, ESD bag, which is placed in a cardboard shipping box. It is important to note that unused moisture sensitive parts need to be resealed in the moisture barrier bag. If the reels exceed the exposure limit and need to be rebaked, most carrier tape and shipping reels are not rated as bakeable at 125°C. If baking is required, devices may be baked according to section 4, table 4-1, column 8 of Joint Industry Standard IPC/JEDECJ-STD-033A.

The following table provides useful information for carrier tape and reels used for shipping the devices described in this document.

RFMD Part Number	Reel Diameter Inch (mm)	Hub Diameter Inch (mm)	Width (mm)	Pocket Pitch (mm)	Feed	Units per Reel
RF3800TR13	13 (330)	4 (102)	12	8	Single	2500
RF3800TR7	7 (178)	2.4 (61)	12	8	Single	750

Carrier Tape Drawing with Part Orientation

Notes:

- All dimensions are in millimeters (mm).
- Unless otherwise specified, all dimension tolerances per EIA-481.

$A_o = 6.70 \pm 0.10$
 $B_o = 5.40 \pm 0.10$
 $F = 5.50 \pm 0.05$
 $K_o = 2.10 \pm 0.10$
 $P = 8.00 \pm 0.10$
 $W = 12.00 +0.30/-0.10$

