



2SA1415/2SC3645

High-Voltage Switching, Predriver Applications

Features

- Adoption of FBET process.
- High breakdown voltage ($V_{CEO}=160V$).
- Excellent linearity of h_{FE} and small C_{ob} .
- Fast switching speed.
- Very small size marking it easy to provide high-density, small-sized hybrid ICs.

Package Dimensions

unit:mm

2038

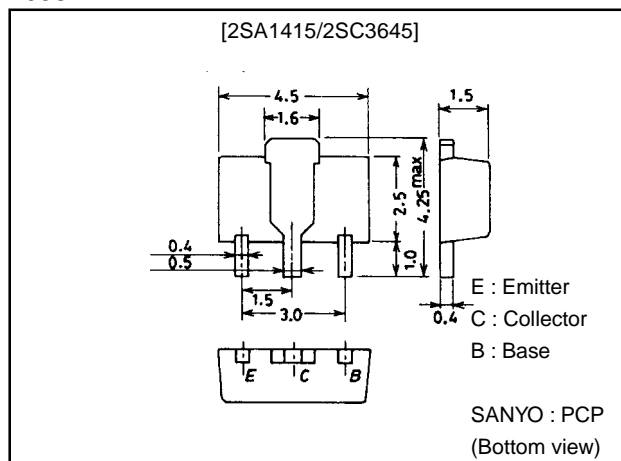

() : 2SA1415

Specifications

Absolute Maximum Ratings at $T_a = 25^\circ C$

Parameter	Symbol	Conditions	Ratings	Unit
Collector-to-Base Voltage	V_{CBO}		(-)180	V
Collector-to-Emitter Voltage	V_{CEO}		(-)160	V
Emitter-to-Base Voltage	V_{EBO}		(-)5	V
Collector Current	I_C		(-)140	mA
Collector Current (Pulse)	I_{CP}		(-)200	mA
Collector Dissipation	$PC1$		500	mW
	$PC2$	Mounted on ceramic board (250mm ² ×0.8mm)	1.3	W
Junction Temperature	T_j		150	$^\circ C$
Storage Temperature	T_{stg}		-55 to +150	$^\circ C$

Electrical Characteristics at $T_a = 25^\circ C$

Parameter	Symbol	Conditions	Ratings			Unit
			min	typ	max	
Collector Cutoff Current	I_{CBO}	$V_{CB}=(-)80V, I_E=0$			(-)100	nA
Emitter Cutoff Current	I_{EBO}	$V_{EB}=(-)4V, I_C=0$			(-)100	nA
DC Current Gain	h_{FE}	$V_{CE}=(-)5V, I_C=(-)10mA$	100*		400*	
Gain-Bandwidth Product	f_T	$V_{CE}=(-)10V, I_C=(-)10mA$		150		MHz
Output Capacitance	C_{ob}	$V_{CB}=(-)10V, f=1MHz$		(4.0)		pF
					3.0	pF
Collector-to-Emitter Saturation Voltage	$V_{CE(sat)}$	$I_C=(-)50mA, I_B=(-)5mA$		(-0.14)	(-0.4)	V
				0.07	0.3	V
Turn-ON Time	t_{on}	See sepcified Test Circuit.		0.1		μs
Storage Time	t_{stg}	See sepcified Test Circuit.		1.5		μs
Fall Time	t_f	See sepcified Test Circuit.		0.1		μs

* : The 2SA1415/2SC3645 are classified by 10mA h_{FE} as follows :

100	R	200	140	S	280	200	T	400
-----	---	-----	-----	---	-----	-----	---	-----

Marking 2SA1415 : AA h_{FE} rank : R, S, T
 2SC3645 : CA

2SA1415/2SC3645

Switching Time Test Circuit

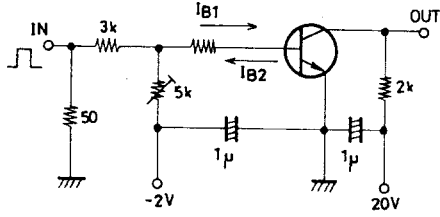

$$I_C = 10I_{B1} = 10I_{B2} = 10\text{mA}$$

(For PNP, the polarity is reversed)

Unit (resistance : Ω , capacitance : F)

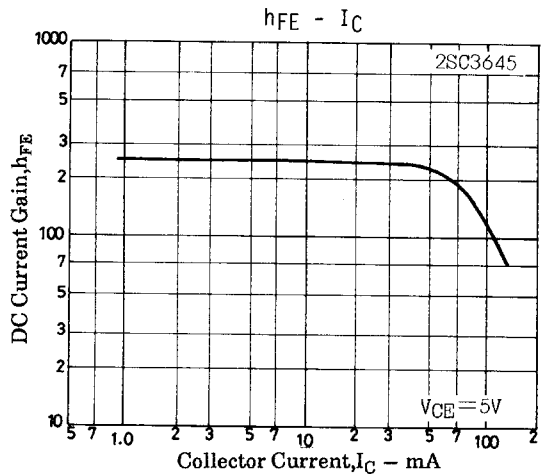
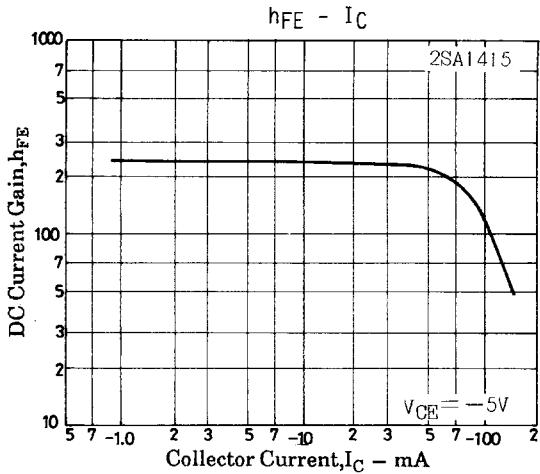
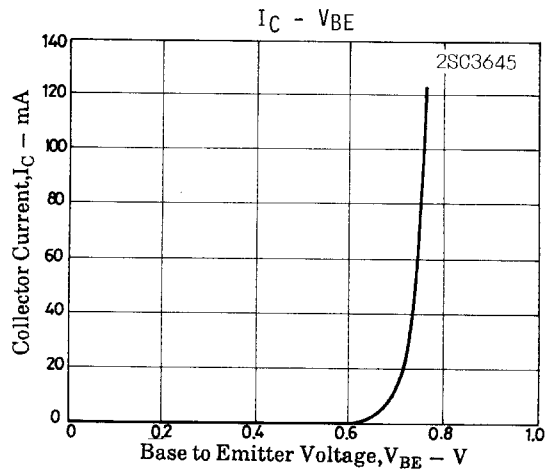
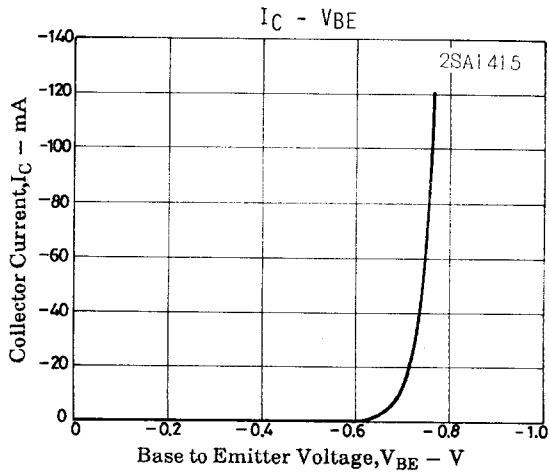
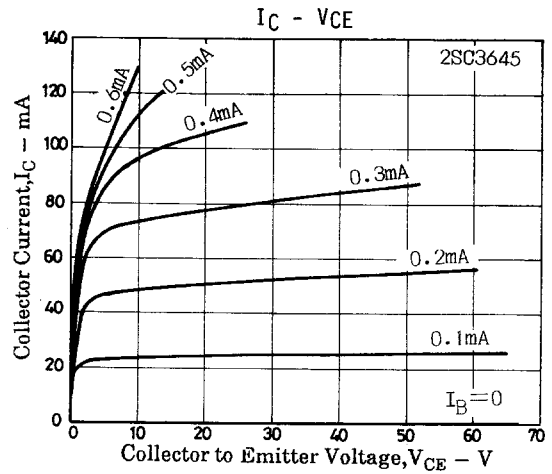
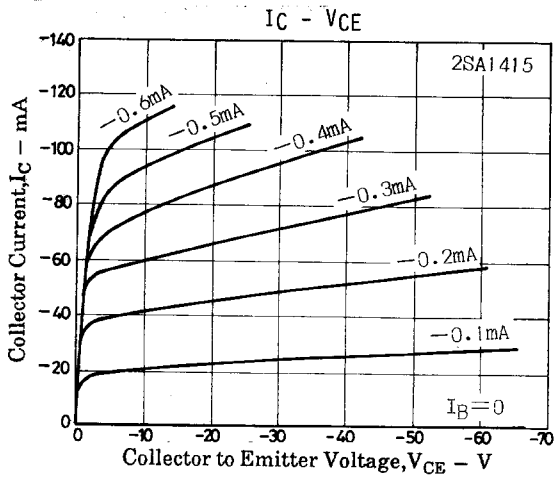

2SA1415/2SC3645

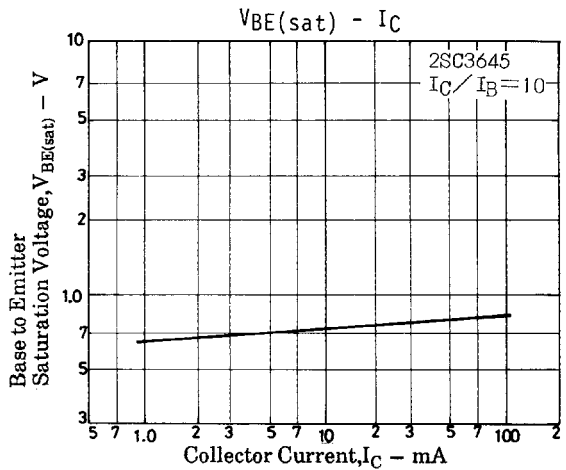
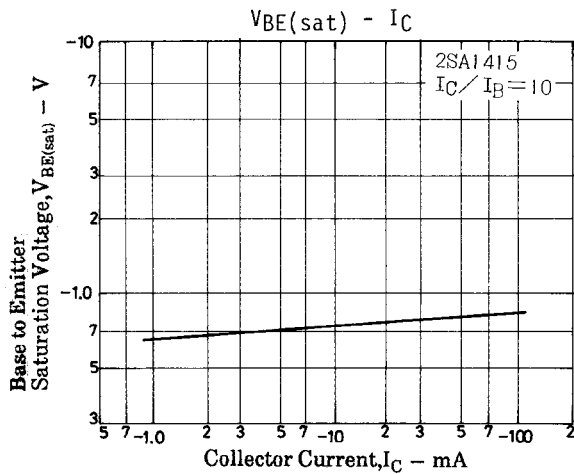
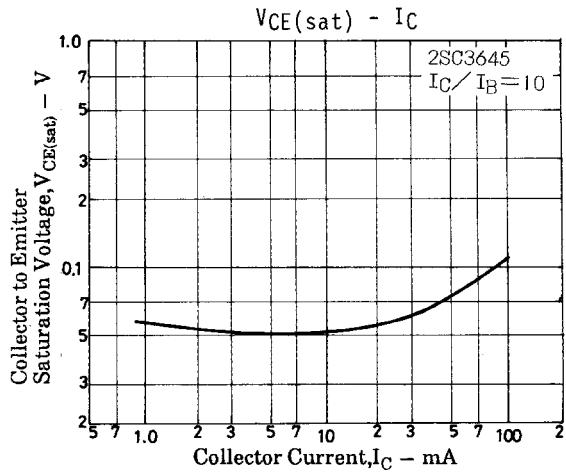
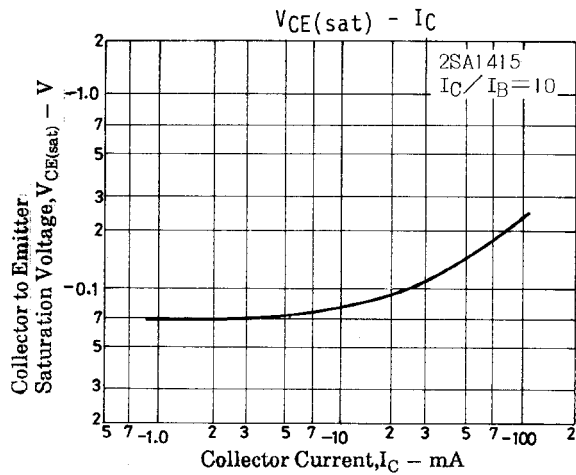
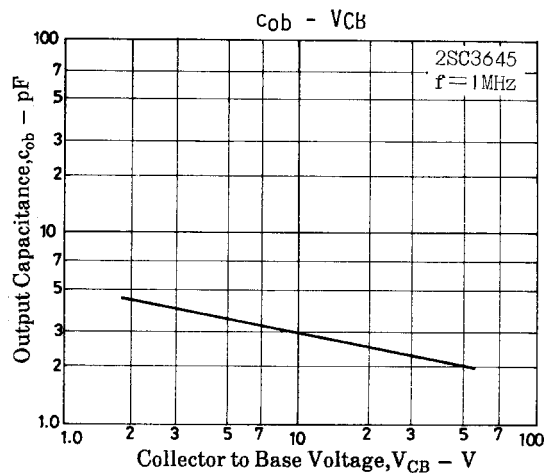
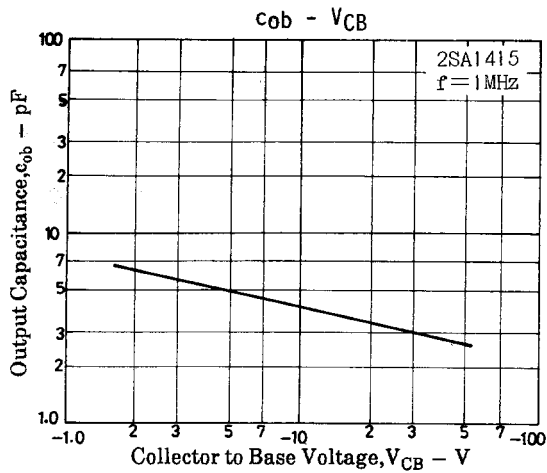
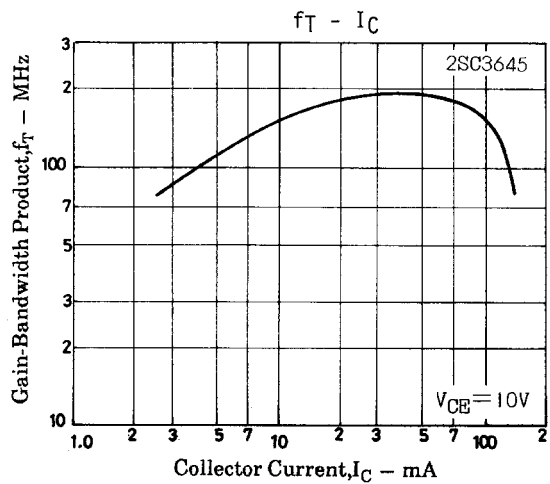
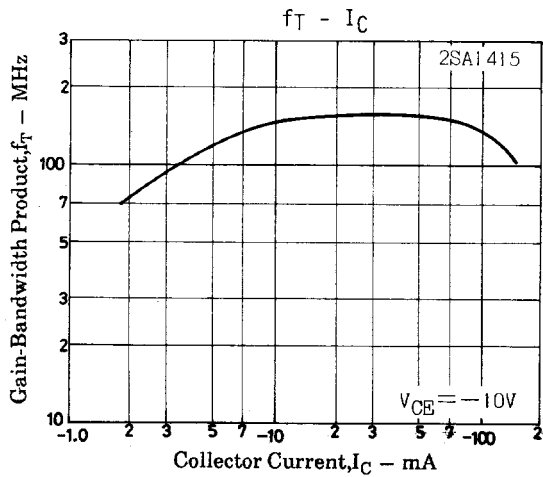

2SA1415/2SC3645

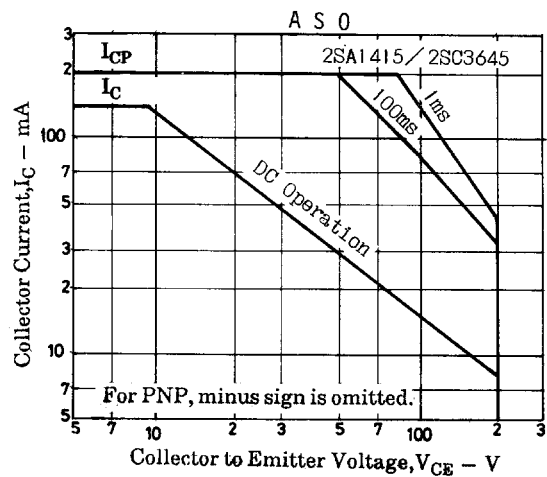
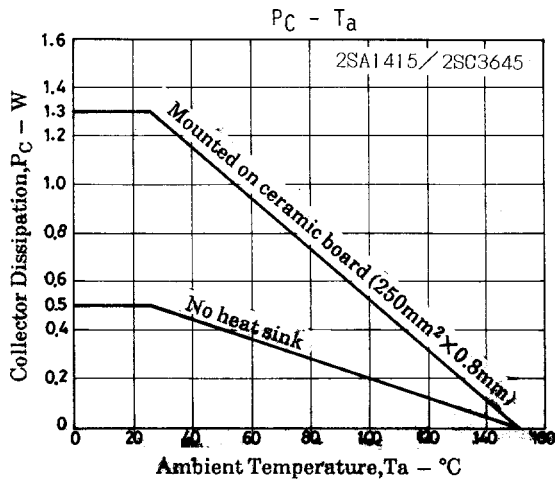

- No products described or contained herein are intended for use in surgical implants, life-support systems, aerospace equipment, nuclear power control systems, vehicles, disaster/crime-prevention equipment and the like, the failure of which may directly or indirectly cause injury, death or property loss.
- Anyone purchasing any products described or contained herein for an above-mentioned use shall:
 - ① Accept full responsibility and indemnify and defend SANYO ELECTRIC CO., LTD., its affiliates, subsidiaries and distributors and all their officers and employees, jointly and severally, against any and all claims and litigation and all damages, cost and expenses associated with such use:
 - ② Not impose any responsibility for any fault or negligence which may be cited in any such claim or litigation on SANYO ELECTRIC CO., LTD., its affiliates, subsidiaries and distributors or any of their officers and employees jointly or severally.
- Information (including circuit diagrams and circuit parameters) herein is for example only; it is not guaranteed for volume production. SANYO believes information herein is accurate and reliable, but no guarantees are made or implied regarding its use or any infringements of intellectual property rights or other rights of third parties.

This catalog provides information as of July, 1998. Specifications and information herein are subject to change without notice.