



2SC5027E

NPN SILICON TRANSISTOR

HIGH VOLTAGE AND HIGH RELIABILITY TRANSISTOR

■ FEATURES

- * High Speed Switching
- * Wide SOA

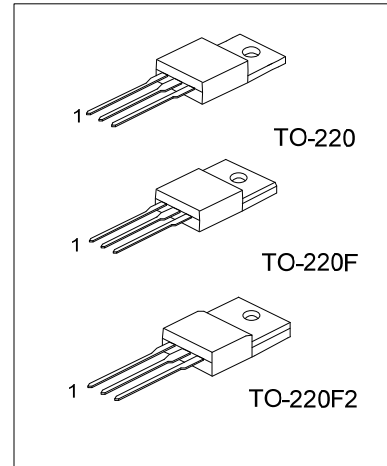

■ ORDERING INFORMATION

Order Number		Package	Pin Assignment			Packing
Lead Free	Halogen Free		1	2	3	
2SC5027EL-x-TA3-T	2SC5027EL-x-TA3-T	TO-220	B	C	E	Tube
2SC5027EL-x-TF2-T	2SC5027EL-x-TF2-T	TO-220F2	B	C	E	Tube
2SC5027EL-x-TF3-T	2SC5027EL-x-TF3-T	TO-220F	B	C	E	Tube

<p>2SC5027EL-x-TA3-T</p>	<p>(1) Packing Type (2) Package Type (3) Rank (4) Lead Plating</p> <p>(1) T: Tube (2) TA3: TO-220, TF3: TO-220F (3) x: refer to Classification of h_{FE1} (4) L: Lead Free Plating, Blank: Pb/Sn</p>
--------------------------	---

■ ABSOLUTE MAXIMUM RATINGS ($T_C = 25^\circ\text{C}$)

PARAMETER		SYMBOL	RATINGS	UNIT
Collector-Base Voltage		V_{CBO}	750	V
Collector-Emitter Voltage		V_{CEO}	700	V
Collector-Emitter Voltage		V_{EBO}	7	V
Peak Collector Current		I_C	3	A
Collector Current (Pulse)		I_{CP}	10	A
Base Current		I_B	1.5	A
Power Dissipation	TO-220/TO-220F	P_D	50	W
	TO-220F2		52	
Junction Temperature		T_J	150	$^\circ\text{C}$
Storage Temperature		T_{STG}	-40 ~ +150	$^\circ\text{C}$

Note Absolute maximum ratings are those values beyond which the device could be permanently damaged.

Absolute maximum ratings are stress ratings only and functional device operation is not implied.

■ ELECTRICAL CHARACTERISTICS ($T_C = 25^\circ\text{C}$, unless otherwise specified.)

PARAMETER	SYMBOL	TEST CONDITIONS	MIN	TYP	MAX	UNIT
Collector-Base Breakdown Voltage	BV_{CBO}	$I_C=1\text{mA}, I_E=0$	750			V
Collector-Emitter Breakdown Voltage	BV_{CEO}	$I_C=5\text{mA}, I_B=0$	700			V
Emitter-Base Breakdown Voltage	BV_{EBO}	$I_E=1\text{mA}, I_C=0$	7			V
Collector-Emitter sustaining Voltage	$V_{CEO(SUS)}$	$I_C=1.5\text{A}, I_{B1}=-I_{B2}=0.3\text{A}$ $L=2\text{mH}$, Clamped	700			V
Collector Cut-off Current	I_{CBO}	$V_{CB}=750\text{V}, I_E=0$			10	μA
Emitter Cut-off Current	I_{EBO}	$V_{EB}=5\text{V}, I_C=0$			10	μA
DC Current Gain	h_{FE1}	$V_{CE}=5\text{V}, I_C=0.2\text{A}$	10		40	
	h_{FE2}	$V_{CE}=5\text{V}, I_C=1\text{A}$	8			
Collector-Emitter Saturation Voltage	$V_{CE(SAT)}$	$I_C=1.5\text{A}, I_B=0.3\text{A}$			2	V
Base-Emitter Saturation Voltage	$V_{BE(SAT)}$	$I_C=1.5\text{A}, I_B=0.3\text{A}$			1.5	V
Output Capacitance	C_{OB}	$V_{CB}=10\text{V}, f=1\text{MHz}, I_E=0$		60		pF
Current Gain Bandwidth Product	f_T	$V_{CE}=10\text{V}, I_C=0.2\text{A}$		15		MHz
Turn ON Time	t_{ON}	$V_{CC}=400\text{V}$			0.5	μs
Storage Time	t_S	$I_C=5\text{A}, I_{B1}=-2.5\text{A}, I_{B2}=2\text{A}$			3	μs
Fall Time	t_F	$R_L=200\Omega$			0.3	μs

■ CLASSIFICATION of h_{FE1}

CLASSIFICATION	N	R	O
RANGE	10 ~ 20	15 ~ 30	20 ~ 40

TYPICAL CHARACTERISTICS

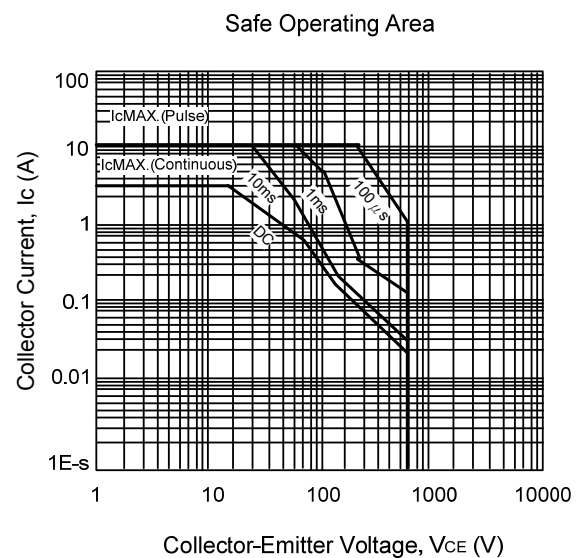
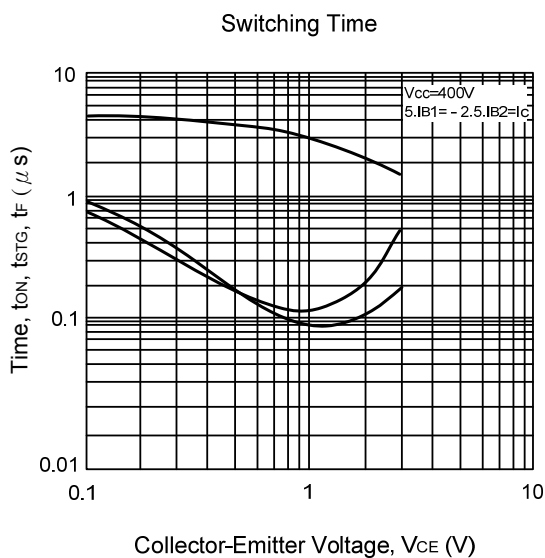
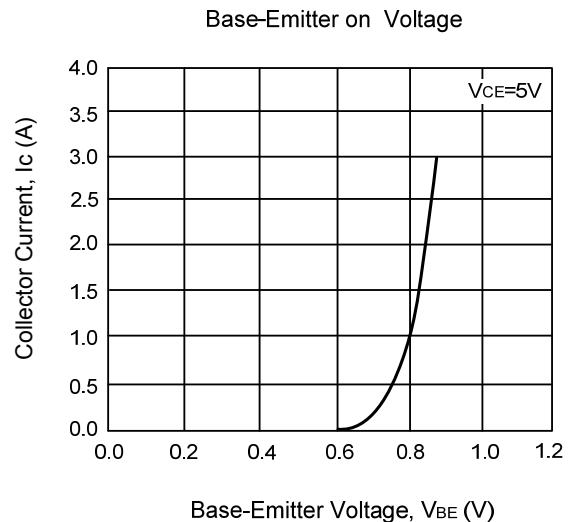
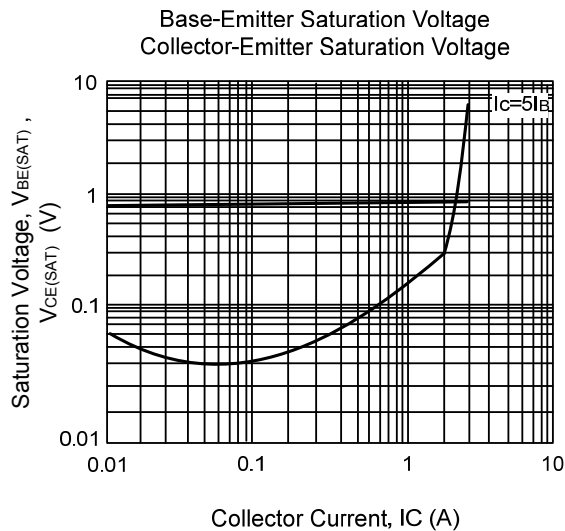
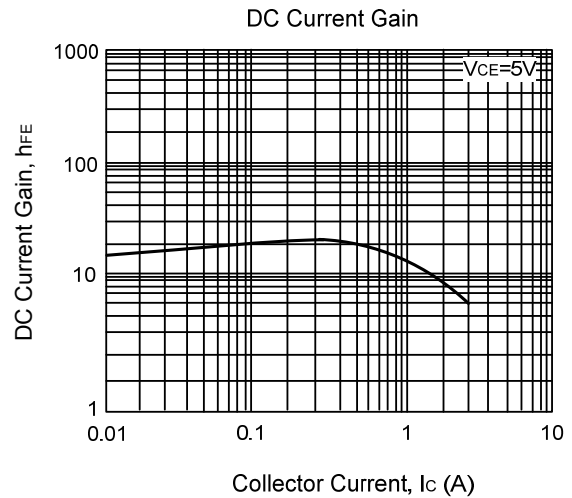
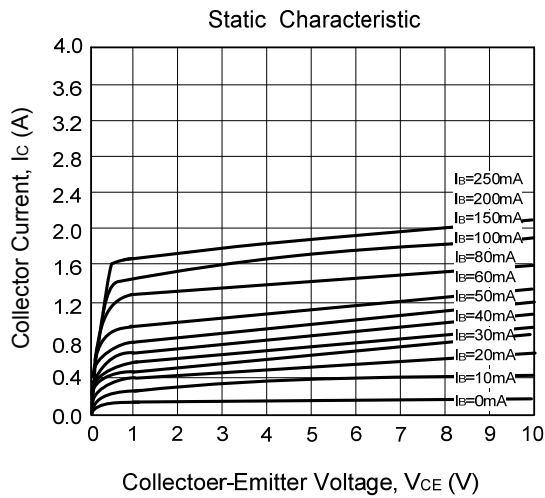

■ TYPICAL CHARACTERISTICS(Cont.)

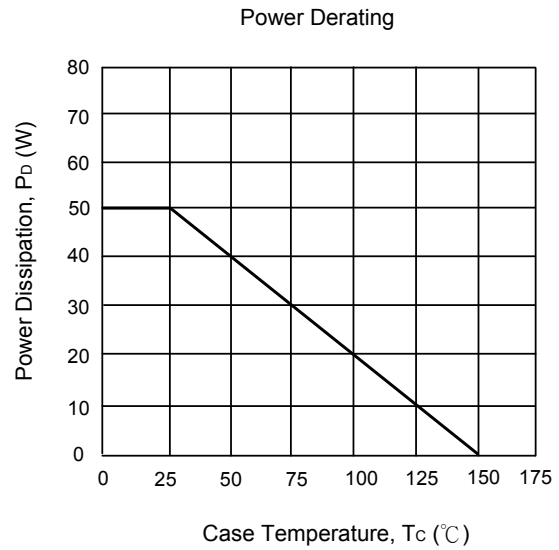
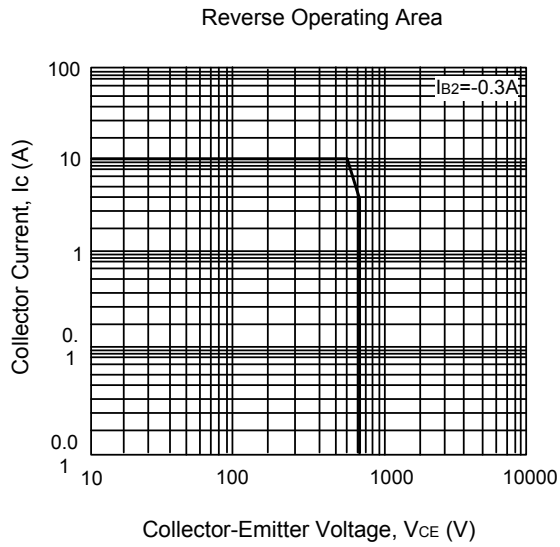

UTC assumes no responsibility for equipment failures that result from using products at values that exceed, even momentarily, rated values (such as maximum ratings, operating condition ranges, or other parameters) listed in products specifications of any and all UTC products described or contained herein. UTC products are not designed for use in life support appliances, devices or systems where malfunction of these products can be reasonably expected to result in personal injury. Reproduction in whole or in part is prohibited without the prior written consent of the copyright owner. The information presented in this document does not form part of any quotation or contract, is believed to be accurate and reliable and may be changed without notice.