

Low Capacitance TVS Diode Array for ESD Protection

UESD6V8L4A SC70-5/SC88A/SOT353
UESD6V8L4B SC89-5/SOT553/SOT665
UESD6V8L5A6 SC70-6/SC88/SOT363
UESD6V8L5B SC89-6/SOT563/SOT666

General Description

The UESD6V8Lxx of TVS diode array is designed to protect sensitive electronics from damage or latch-up due to ESD, for use in applications where board space is at a premium. It is unidirectional device and may be used on lines where the signal polarities are above ground. UESD6V8L4A and UESD6V8L4B protect up to four lines while UESD6V8L5A6 and UESD6V8L5B will protect up to five lines. TVS diodes are solid-state devices feature large cross-sectional area junctions for conducting high transient currents, specifically for transient suppression. It offers desirable characteristics for board level protection including fast response time, low operating, low clamping voltage, and no device degradation. The UESD6V8Lxx may be used to meet the immunity requirements of IEC 61000-4-2, level 4. The small package makes them ideal for use in portable electronics such as cell phones, PDA's, notebook computers, and digital cameras. The UESD6V8Lxx is fabricated using dual diffusion technology, offer low junction capacitance (20pF), which is required in high speed signal protection application.

Applications

- Cellular Handsets & Accessories
- Cordless Phones
- Personal Digital Assistants (PDA's)
- Notebooks & Handhelds
- Portable Instrumentation
- Digital Cameras
- Peripherals
- MP3 Players

Features

- Transient Protection for Data Lines to IEC 61000-4-2 (ESD) $\pm 15\text{kV}$ (Air), $\pm 8\text{kV}$ (Contact)
- Ultra-Small Package
- Working Voltages: 5V
- Low Leakage Current
- Low Clamping Voltage
- Solid-State Silicon Avalanche Technology

Ordering Information

Part Number	Working Voltage	Packaging Type	Channel	Marking Code	Shipping Qty
UESD6V8L4A	5.0V	SC70-5/SC88A/SOT353	4	UKA	3000pcs/7Inch Tape & Reel
UESD6V8L4B		SC89-5/SOT553/SOT665		USB	
UESD6V8L5A6		SC70-6/SC88/SOT363	5	U6A	
UESD6V8L5B		SC89-6/SOT563/SOT666		UB	

Pin Configurations

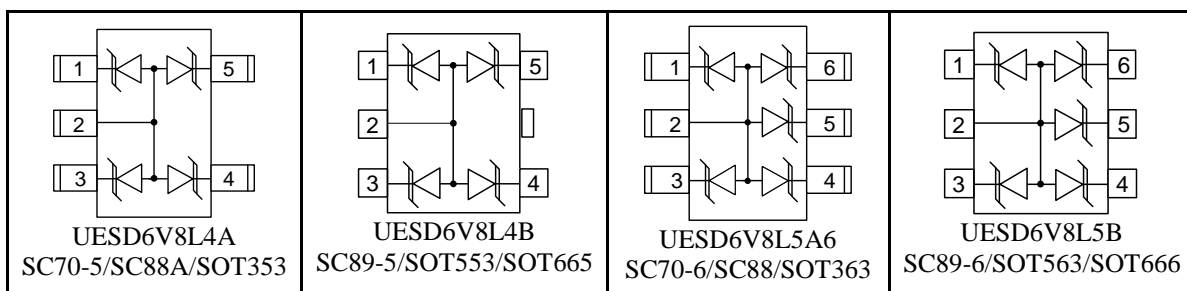

Top View

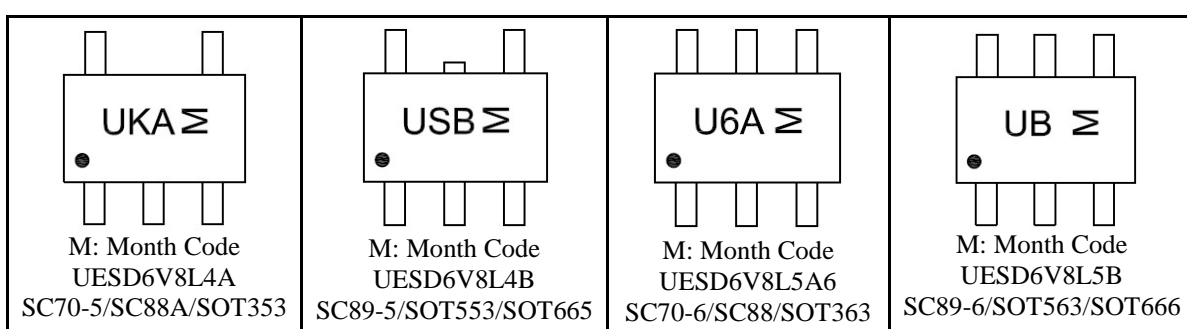

Absolute Maximum Ratings

Rating	Symbol	Value	Unit
Peak Pulse Power ($t_p = 8/20\mu s$)	P_{PK}	55	Watts
Lead Soldering Temperature	T_L	260(10 sec.)	°C
Operating Temperature	T_J	-55 to +125	°C
Storage Temperature	T_{STG}	-55 to +125	°C
Maximum Junction Temperature	T_{JMAX}	150	°C

Electrical Characteristics

Parameter	Symbol	Conditions	Min	Typ	Max	Unit
Reverse Stand-Off Voltage	V_{RWM}				5	V
Reverse Breakdown Voltage	V_{BR}	$I_t = 1mA$	6	6.8	7.2	V
Reverse Leakage Current	I_R	$V_{RWM} = 5V, T=25^\circ C$		0.005	0.1	μA
Clamping Voltage	V_C	$I_{PP} = 1A, t_p = 8/20\mu s$			6	V
		$I_{PP} = 2A, t_p = 8/20\mu s$			8	
		$I_{PP} = 5A, t_p = 8/20\mu s$			10.8	
Junction Capacitance	C_J	Pin 1,3,4,5,6 to 2 $V_R = 0V, f = 1MHz$		20	25	pF
Junction Capacitance	C_J	Pin 1,3,4,5,6 to 2 $V_R = 2.5V, f = 1MHz$		12	17	pF

Typical Operating Characteristics

Non-Repetitive Peak Pulse Power vs. Pulse Time

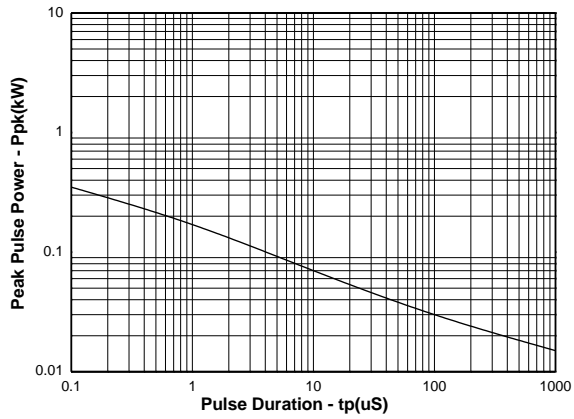

Clamping Voltage vs. Peak Pulse Current

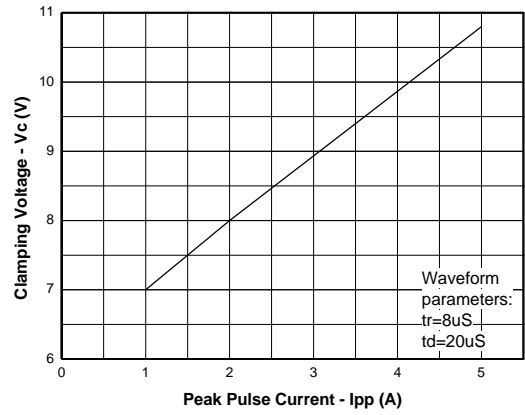

Forward Voltage vs. Forward Current

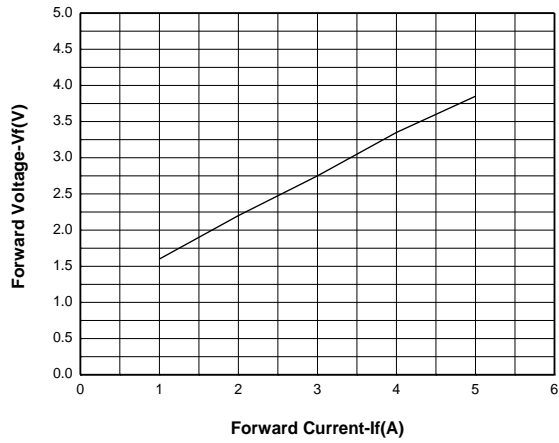

Junction Capacitance vs. Reverse Voltage

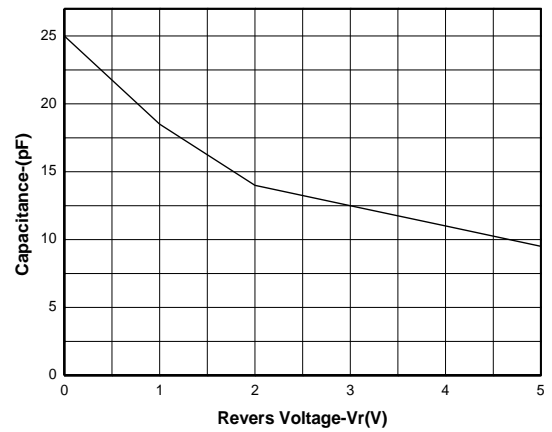

Application Information

UESD6V8Lxx can use as unidirectional lines or bidirectional lines protector. For example, UESD6V8L4B can use as a four unidirectional lines protector, and also can use as a three bidirectional lines protector (as figure1 shows). For bidirectional applications, the junction capacitance between I/O ports and ground is half of the single TVS's junction capacitance, that is to say the typical value of the junction capacitance between I/O ports and ground is 6pF. The break down voltage of these two series connection TVS is a forwards voltage (about 0.7V) higher than a single TVS's.

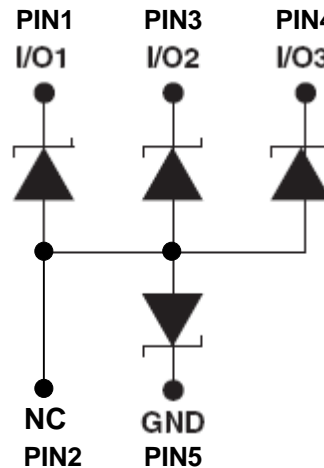

Figure1: UESD6V8L4B use as three bidirectional lines protector

Circuit Board Layout Recommendations for Suppression of ESD

Good circuit board layout is critical for the suppression of ESD induced transients. The following guidelines are recommended:

1. Place the TVS near the input terminals or connectors to restrict transient coupling.
2. Minimize the path length between the TVS and the protected line.
3. Minimize all conductive loops including power and ground loops.
4. The ESD transient return path to ground should be kept as short as possible.
5. Never run critical signals near board edges.
6. Use ground planes whenever possible. For multilayer printed-circuit boards, use ground vias.
7. Keep parallel signal paths to a minimum.
8. Avoid running protection conductors in parallel with unprotected conductor.
9. Minimize all printed-circuit board conductive loops including power and ground loops.
10. Avoid using shared transient return paths to a common ground point.

Package Information

UESD6V8L4A SC70-5/SC88A/SOT353

Outline Drawing

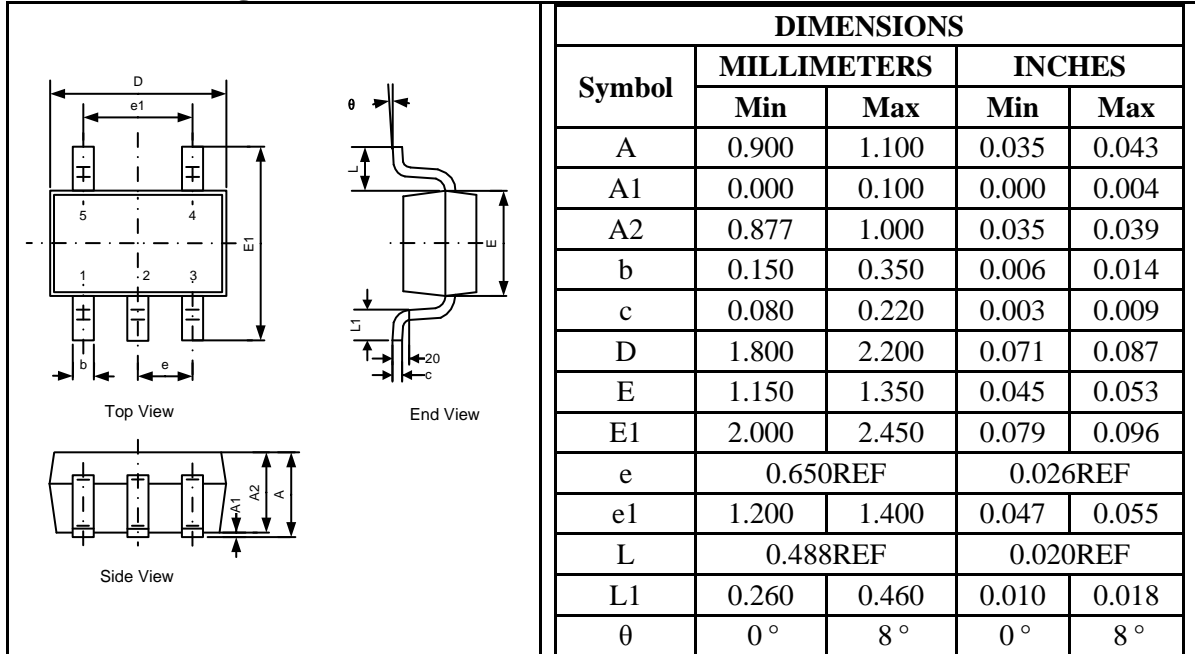

Land Pattern

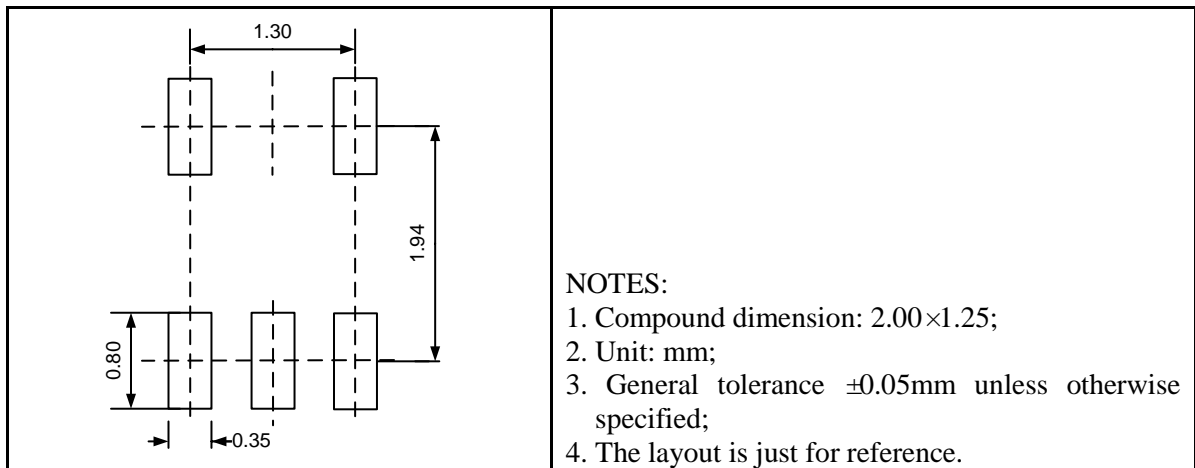

Tape and Reel Orientation

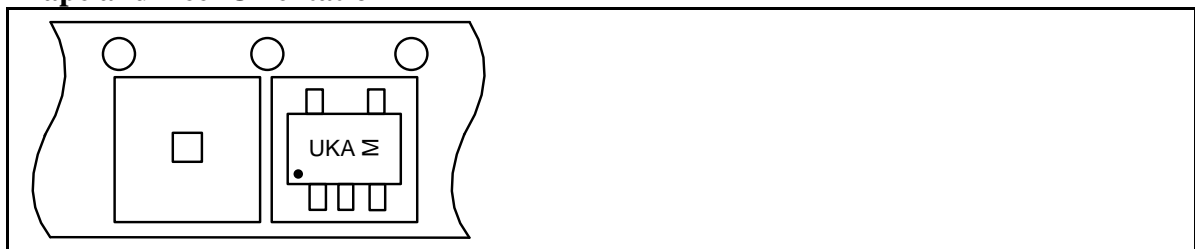

UESD6V8L4B SC89-5/SOT553/SOT665

Outline Drawing

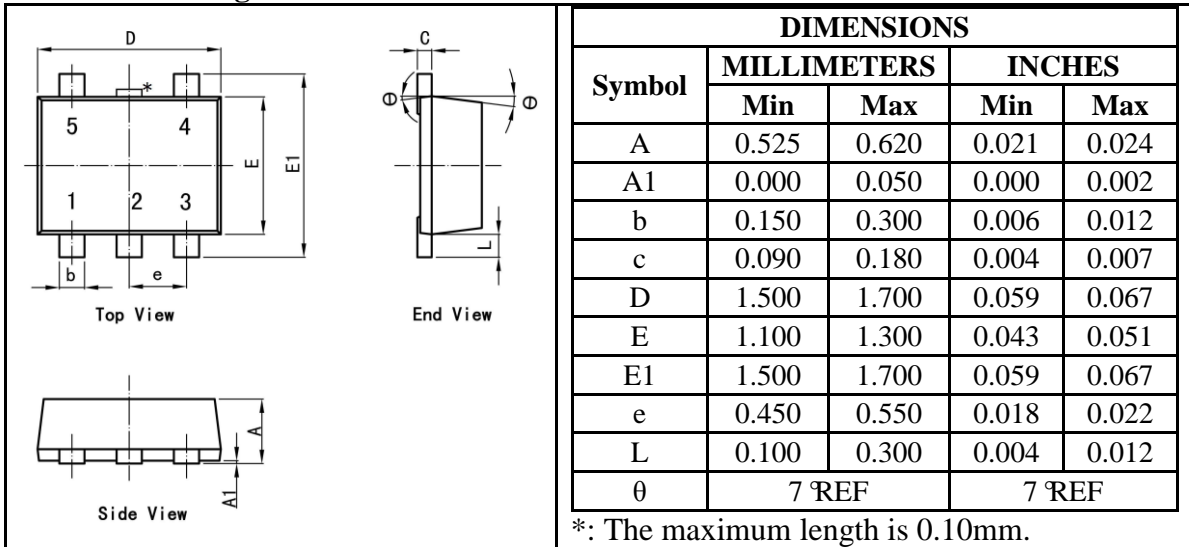

Land Pattern

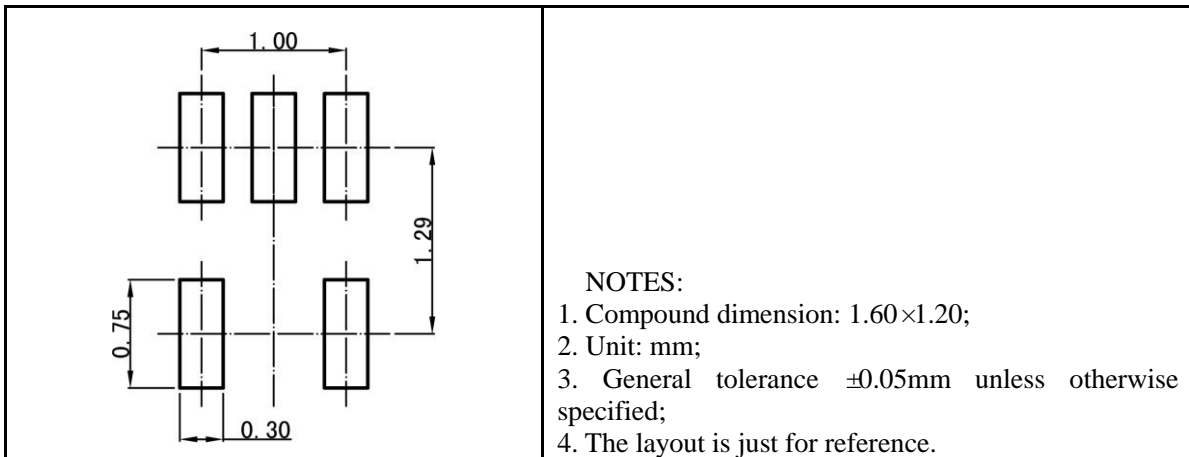

Tape and Reel Orientation



UESD6V8L5A6 SC70-6/SC88/SOT363

Outline Drawing

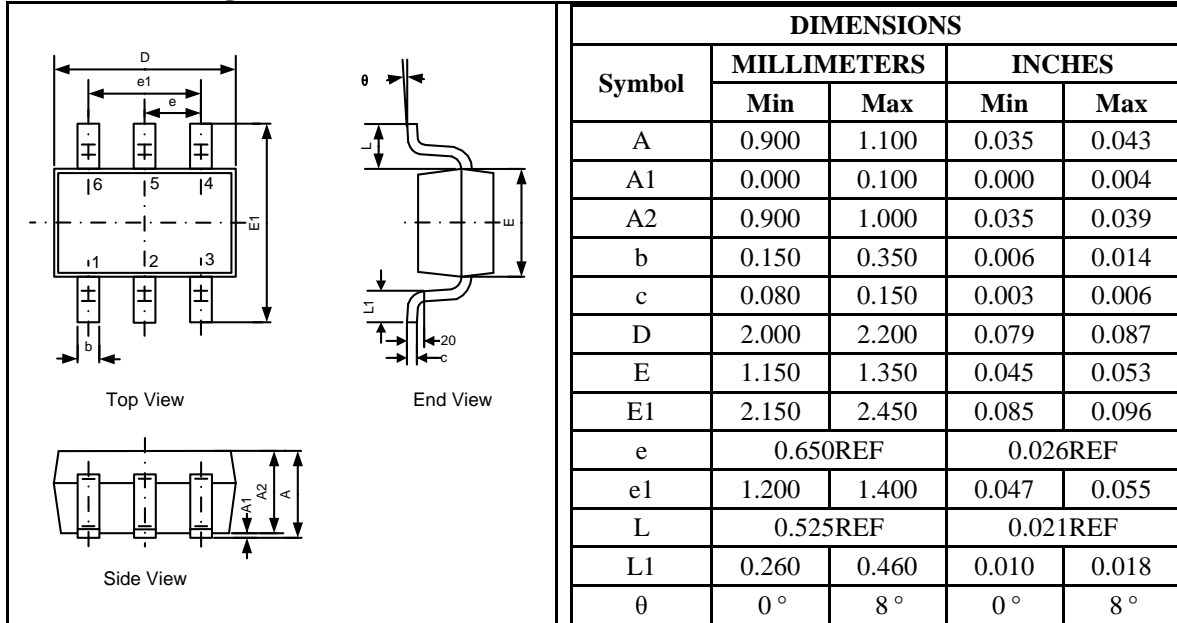

Land Pattern

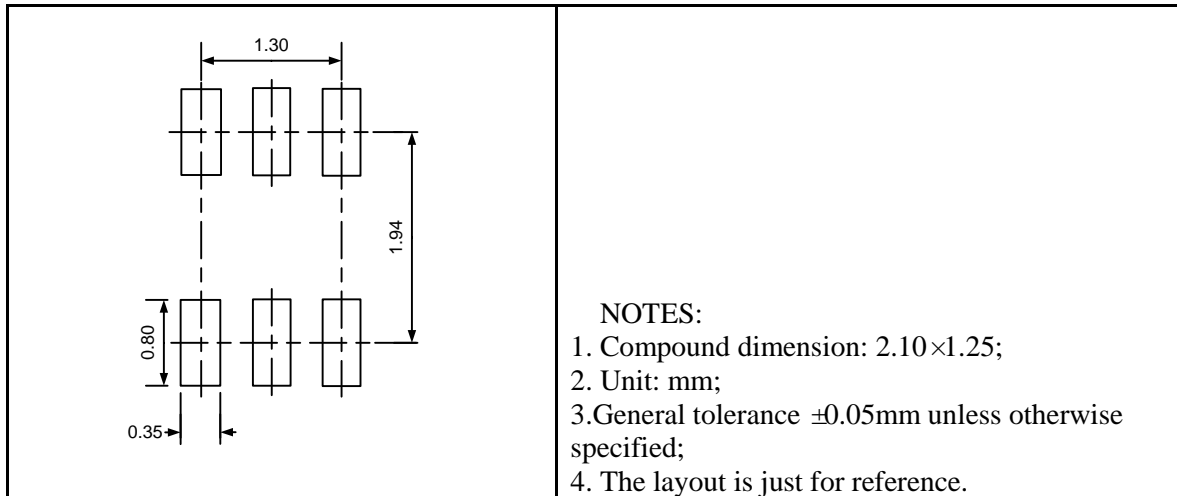

Tape and Reel Orientation

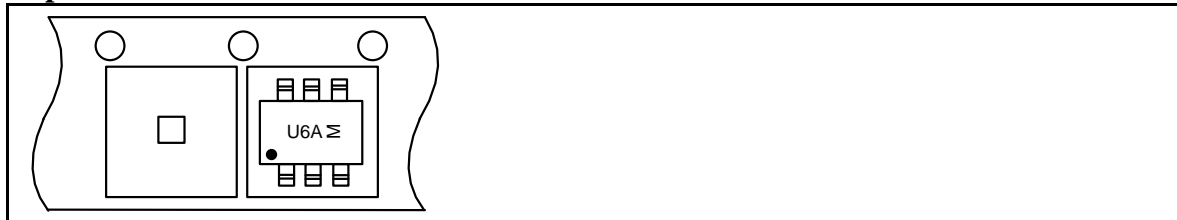

UESD6V8L5B SC89-6/SOT563/SOT666

Outline Drawing

DIMENSIONS				
Symbol	MILLIMETERS		INCHES	
	Min	Max	Min	Max
A	0.525	0.600	0.021	0.024
A1	0.000	0.050	0.000	0.002
b	0.150	0.300	0.006	0.012
c	0.090	0.180	0.004	0.007
D	1.500	1.700	0.059	0.067
E	1.100	1.300	0.043	0.051
E1	1.500	1.700	0.059	0.067
e	0.450	0.550	0.018	0.022
L	0.100	0.300	0.004	0.012
θ	7 REF		7 REF	

Land Pattern

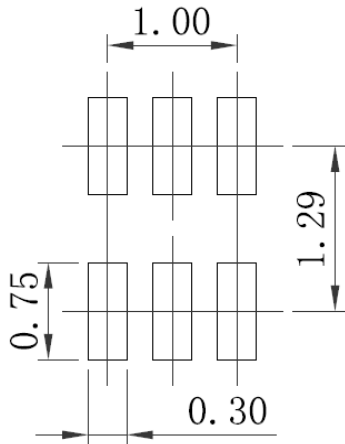
	<p>NOTES:</p> <ol style="list-style-type: none"> Compound dimension: 1.60×1.20; Unit: mm; General tolerance ± 0.05mm unless otherwise specified; The layout is just for reference.
------------------------------------------------------------------------------------	---------------------------------------------------------------------------------------------------------------------------------------------------------------------------------------------------------------------------------------------

Tape and Reel Orientation

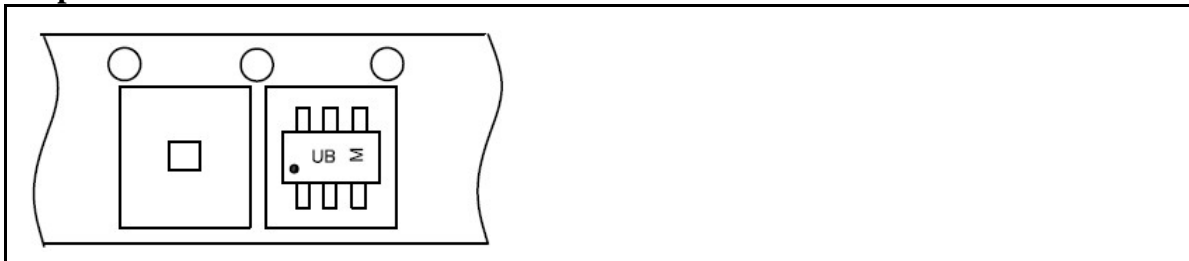

IMPORTANT NOTICE

The information in this document has been carefully reviewed and is believed to be accurate. Nonetheless, this document is subject to change without notice. Union assumes no responsibility for any inaccuracies that may be contained in this document, and makes no commitment to update or to keep current the contained information, or to notify a person or organization of any update. Union reserves the right to make changes, at any time, in order to improve reliability, function or design and to attempt to supply the best product possible.



Union Semiconductor, Inc

Add: Unit 606, No.570 Shengxia Road, Shanghai 201210

Tel: 021-51093966

Fax: 021-51026018

Website: www.union-ic.com