

1FI150B-060(150A)

FAST RECOVERY DIODE MODULE

600V / 150A 1 in one-package

FAST RECOVERY DIODE MODULE

■ Features

- Short Reverse Recovery Time
- Variety of Connection Menu
- Insulated Type

■ Applications

- Arc-Welders
- Free-Wheeling Diode
- High Speed Rectifiers

■ Maximum ratings and characteristics

● Absolute maximum ratings

Item	Symbol	Conditions	Rating	Unit
Repetitive peak reverse voltage	V_{RRM}		600	V
Non-repetitive peak reverse voltage	V_{RSM}		650	V
Average output current	$I_{F(AV)}$	50/60Hz Sine wave, $T_c=92^\circ\text{C}$	150	A
Surge current	I_{FSM}	From rated load, Sine wave 10ms	2000	A
I^2t	I^2t	From rated load	16000	A^2s
Operating junction temperature	T_j		-40 to +150	$^\circ\text{C}$
Storage temperature	T_{stg}		-40 to +125	$^\circ\text{C}$
Isolation voltage	V_{is}		AC2000(1min.)	V
Screw torque	Terminals	(M6)	3.5	N·m
	Mountings	(M5)	2.5	N·m

● Electrical characteristics ($T_a=25^\circ\text{C}$ Unless otherwise specified)

Item	Symbol	Conditions	Min.	Typ.	Max.	Unit
Forward voltage drop	V_{FM}	$T_j=25^\circ\text{C}$, $I_{FM}=150\text{A}$			1.10	V
Reverse current	I_{RRM}	$T_j=150^\circ\text{C}$, $V_R=V_{RRM}$			15	mA
Reverse recovery time	t_{rr}	$T_j=25^\circ\text{C}$, $I_F=75\text{A}$, $-di/dt=375\text{A}/\mu\text{s}$			0.5	μs

● Thermal Characteristics

Item	Symbol	Conditions	Min.	Typ.	Max.	Unit
Thermal resistance	$R_{th(j-c)}$	Junction to case			0.32	$^\circ\text{C}/\text{W}$
	$R_{th(c-f)}$	the base to cooling fin *			0.06	$^\circ\text{C}/\text{W}$

* : With Thermal Compound

■ Outline Drawings, mm

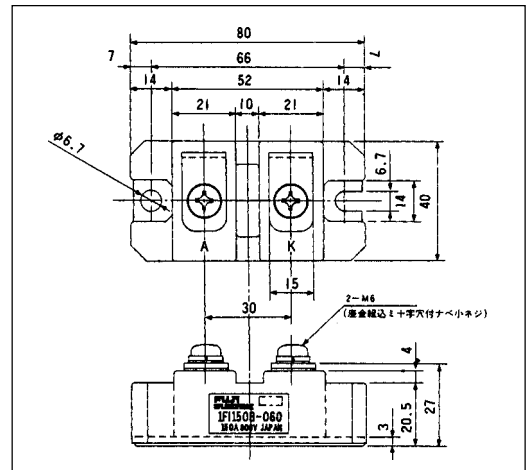

■ Inner Circuit Schematic

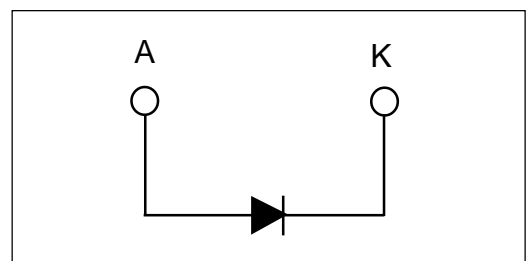

■ Characteristics

Forward Characteristics

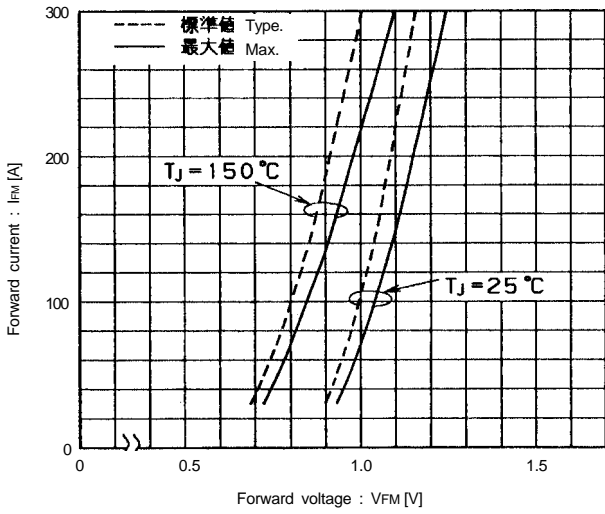

Output Current vs. Total Loss

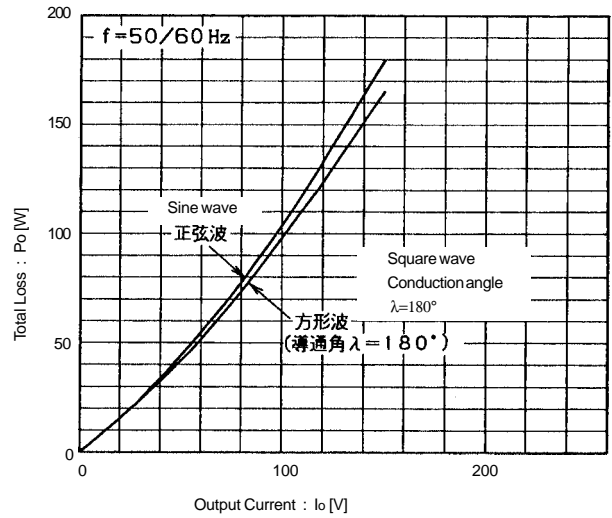

Reverse Recovery Characteristics

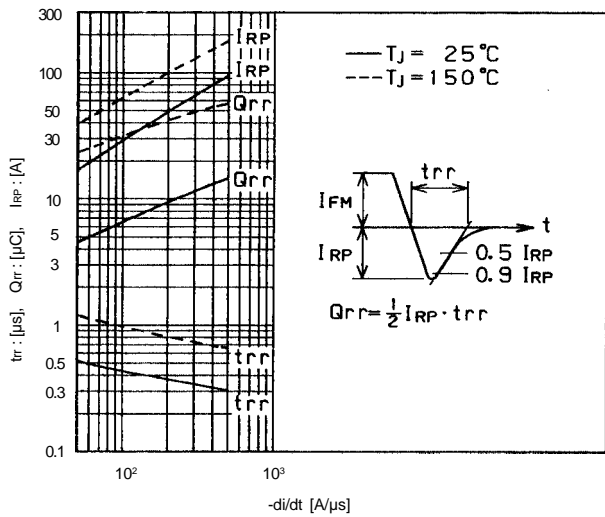

Surge Current

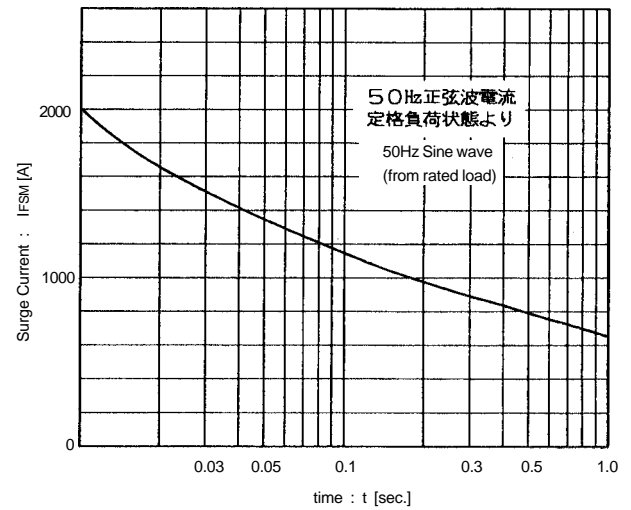

Transient Thermal Impedance

