

## ZENER DIODES

POWER DISSIPATION: 5.0 W

### FEATURES

- ◇ Silicon planar power zener diodes
- ◇ For use in stabilizing and clipping circuits with high power rating.
- ◇ Standard zener voltage tolerance is  $\pm 10\%$ . Add suffix "B" for  $\pm 5\%$  tolerance. other zener voltage and tolerances are available upon request.

### MECHANICAL DATA

- ◇ Case: DO-27
- ◇ Terminals: solderable per MIL-STD-202, method 208
- ◇ Polarity: cathode Band
- ◇ Marking: type number
- ◇ Approx. weight: 1.15 grams.

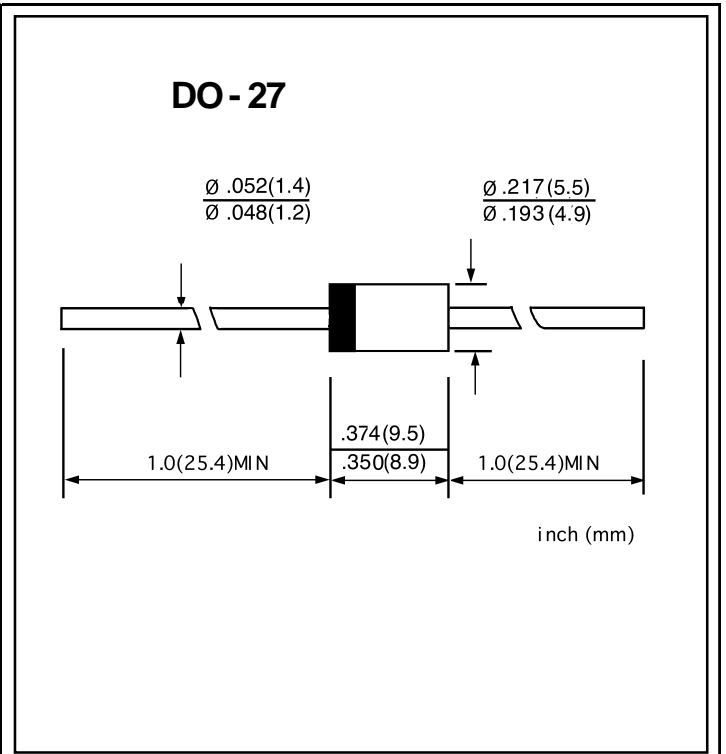

### MAXIMUM RATINGS AND ELECTRICAL CHARACTERISTICS

Ratings at 25°C ambient temperature unless otherwise specified.

Single phase, half wave, 60 Hz, resistive or inductive load. For capacitive load, derate by 20%.

	SYMBOL	VALUE	UNIT
Zener current (see Table "Characteristics")			
DC power dissipation @ $T_L = 75^\circ\text{C}$ , measure at zero lead length (Fig.1) derate above 75 (NOTE 1)	$P_D$	5.0 40.0	W mW
Peak forward surge current 8.3ms single half sine-wave superimposed on rated load (JEDEC Method)(NOTE 1,2)	$I_{FSM}$	see fig.5	A
Junction temperature	$T_J$	-55---+150	°C
Storage temperature range	$T_s$	-55---+150	°C

NOTES: (1) Mounted on 8.0mm<sup>2</sup> copper pads to each terminal.

www.galaxycn.com

(2) 8.3ms single half sine-wave, or equivalent square wave, duty cycle=4 pulses per minute maximum.

# ELECTRICAL CHARACTERISTICS (T<sub>A</sub>=25 )

Type (Note 1)	Zener voltage (Note 2)		Maximum Zener Impedance (Note 2)		Max Reverse Leakage Current		I <sub>R</sub> (Note 3) A	V <sub>Z</sub> (Note 4) V	I <sub>ZM</sub> (Note 5) mA
	V <sub>Z</sub> @I <sub>ZT</sub> V	I <sub>ZT</sub> mA	Z <sub>ZT</sub> @I <sub>ZT</sub> Ω	Z <sub>ZT</sub> @I <sub>ZK</sub> =1μA Ω	I <sub>R</sub>	V <sub>R</sub>			
					μA	V			
1N5333B	3.3	380	3.0	400	300	1.0	20	0.85	1440
1N5334B	3.6	350	2.5	500	150	1.0	18.7	0.80	1320
1N5335B	3.9	320	2.0	500	50	1.0	17.6	0.54	1220
1N5336B	4.3	290	2.0	500	10	1.0	16.4	0.49	1100
1N5337B	4.7	260	2.0	450	5.0	1.0	15.3	0.44	1010
1N5338B	5.1	240	1.5	400	1.0	1.0	14.4	0.39	930
1N5339B	5.6	220	1.0	400	1.0	2.0	13.4	0.25	865
1N5340B	6.0	200	1.0	300	1.0	3.0	12.7	0.19	790
1N5341B	6.2	200	1.0	200	1.0	3.0	12.4	0.10	765
1N5342B	6.8	175	1.0	200	10	5.2	11.5	0.15	700
1N5343B	7.5	175	1.5	200	10	5.7	10.7	0.15	630
1N5344B	8.2	150	1.5	200	10	6.2	10.0	0.20	580
1N5345B	8.7	150	2.0	200	10	6.6	9.5	0.20	545
1N5346B	9.1	150	2.0	150	7.5	6.9	9.2	0.22	520
1N5347B	10	125	2.0	125	5.0	7.6	8.6	0.22	475
1N5348B	11	125	2.5	125	5.0	8.4	8.0	0.25	430
1N5349B	12	100	2.5	125	2.0	9.1	7.5	0.25	395
1N5350B	13	100	2.5	100	1.0	9.9	7.0	0.25	365
1N5351B	14	100	2.5	75	1.0	10.6	6.7	0.25	340
1N5352B	15	75	2.5	75	1.0	11.5	6.3	0.25	315
1N5353B	16	75	2.5	75	1.0	12.2	6.0	0.30	295
1N5354B	17	70	2.5	75	0.5	12.9	5.8	0.35	280
1N5355B	18	65	2.5	75	0.5	13.7	5.5	0.40	264
1N5356B	19	65	3.0	75	0.5	14.4	5.3	0.40	250
1N5357B	20	65	3.0	75	0.5	15.2	5.1	0.40	237
1N5358B	22	50	3.5	75	0.5	16.7	4.7	0.45	216
1N5359B	24	50	3.5	100	0.5	18.2	4.4	0.55	198
1N5360B	25	50	4.0	110	0.5	19.0	4.3	0.55	190
1N5361B	27	50	5.0	120	0.5	20.6	4.1	0.60	176
1N5362B	28	50	6.0	130	0.5	21.2	3.9	0.60	170
1N5363B	30	40	8.0	140	0.5	22.8	3.7	0.60	158
1N5364B	33	40	10	150	0.5	25.1	3.5	0.60	144
1N5365B	36	30	11	160	0.5	27.4	3.5	0.65	132
1N5366B	39	30	14	170	0.5	29.7	3.1	0.65	122
1N5367B	43	30	20	190	0.5	32.7	2.8	0.70	110
1N5368B	47	25	25	210	0.5	35.8	2.7	0.80	100
1N5369B	51	25	27	230	0.5	38.8	2.5	0.90	93
1N5370B	56	20	35	280	0.5	42.6	2.3	1.00	86
1N5371B	60	20	40	350	0.5	45.5	2.2	1.20	79
1N5372B	62	20	42	400	0.5	47.1	2.1	1.35	76

www.galaxycn.com

# ELECTRICAL CHARACTERISTICS (T<sub>A</sub>=25 )

Type (Note 1)	Zener voltage (Note 2)		Maximum Zener Impedance (Note 2)		Max Reverse Leakage Current		I <sub>R</sub> (Note 3) A	V <sub>Z</sub> (Note 4) V	I <sub>ZM</sub> (Note 5) mA
	V <sub>Z</sub> @I <sub>ZT</sub> V	I <sub>ZT</sub> mA	Z <sub>ZT</sub> @I <sub>ZT</sub> Ω	Z <sub>ZT</sub> @I <sub>ZK</sub> =1μA Ω	I <sub>R</sub>	V <sub>R</sub>			
					μA	V			
1N5373B	68	20	44	500	0.5	51.7	2.0	1.5	70
1N5374B	75	20	45	620	0.5	56.0	1.9	1.6	63
1N5375B	82	15	65	720	0.5	62.2	1.8	1.8	58
1N5376B	87	15	75	760	0.5	66.0	1.7	2.0	54.5
1N5377B	91	15	75	760	0.5	69.2	1.6	2.2	52.5
1N5378B	100	12	90	800	0.5	76.0	1.5	2.5	47.5
1N5379B	110	12	125	1000	0.5	83.6	1.4	2.5	43.0
1N5380B	120	10	170	1150	0.5	91.2	1.3	2.5	39.5
1N5381B	130	10	190	1250	0.5	98.8	1.2	2.5	36.6
1N5382B	140	8.0	230	1500	0.5	106	1.2	2.5	34.0
1N5383B	150	8.0	330	1500	0.5	114	1.1	3.0	31.6
1N5384B	160	8.0	350	1650	0.5	122	1.1	3.0	29.4
1N5385B	170	8.0	380	1750	0.5	129	1.0	3.0	28.0
1N5386B	180	5.0	430	1750	0.5	137	1.0	4.0	26.4
1N5387B	190	5.0	450	1850	0.5	144	0.9	5.0	25.0
1N5388B	200	5.0	480	1850	0.5	152	0.9	5.0	23.6

NOTE:

www.galaxycn.com

1. TOLERANCE AND VOLTAGE DESIGNATION-The JEDEC type numbers shown indicate a tolerance of ±10% with guaranteed limits on only V<sub>Z</sub>, I<sub>R</sub>, I<sub>r</sub>, and V<sub>F</sub> as shown in the electrical characteristics table. Units with guaranteed limits on all seven parameters are indicated by suffix "B" for ±5% tolerance.
2. ZENER VOLTAGE (V<sub>Z</sub>) AND IMPEDANCE (Z<sub>ZT</sub> & Z<sub>ZK</sub>) - Test conditions for zener voltage and impedance are as follows; I<sub>Z</sub> is applied 40±10ms prior to reading. Mounting contacts are located from the inside edge of mounting clips to the body of the diode.
3. SURGE CURRENT (I<sub>r</sub>) - Surge current is specified as the maximum allowable peak, non-recurrent square-wave current with a pulse width, PW, of 8.3ms. The data given in Fig 5. May be used to find the maximum surge current for a square wave of any pulse width between 1 ms by plotting the applicable points on logarithmic paper. Examples of this, using the 6.8v and 200v zeners, are shown in Fig 6. Mounting contact located as specified in NOTE 3.
4. VOLTAGE REGULATION (V<sub>Z</sub>) - Test conditions for voltage regulation are as follows: V<sub>Z</sub> measurements are the made at 10% and then at 50% of the I<sub>Z</sub> max value listed in the electrical characteristics table. The test currents are the same for the 5% and 10% tolerance devices. The test current time duration for each V<sub>Z</sub> measurement is 40±10ms. Mounting contact located as specified in NOTE 2.
5. MAXIMUM REGULATOR CURRENT (I<sub>ZM</sub>) - The maximum current shown is based on the maximum voltage of a 5% type unit. Therefore, it applies only to the B-suffix device. The actual I<sub>ZM</sub> for any device may not exceed the value of 5 watts divided by the actual V<sub>Z</sub> of the device. T<sub>J</sub>=75 at 3/8" maximum from the device body.

**FIG.1 --FORWARD DERATING CURVE**

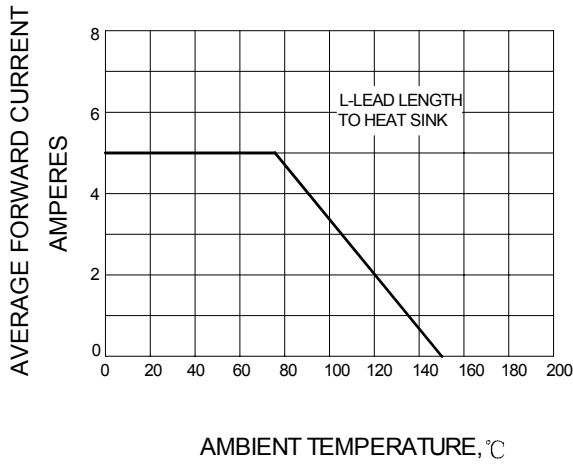

**FIG.2 -- TEMPERATURE COEFFICIENT RANGE**

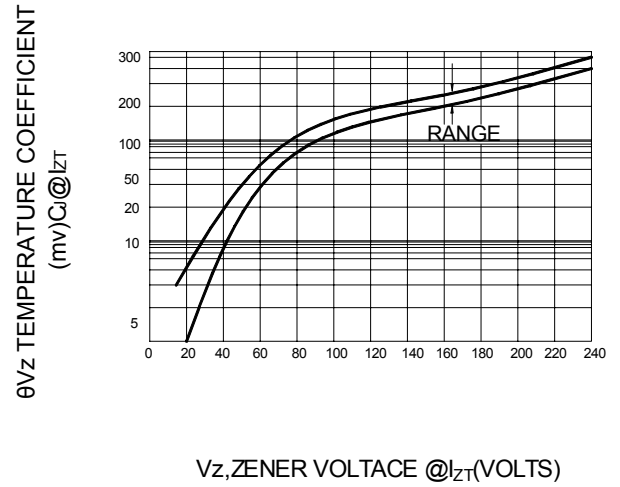

**FIG.3 -- TYPICAL THERMAL RESISTANCE**

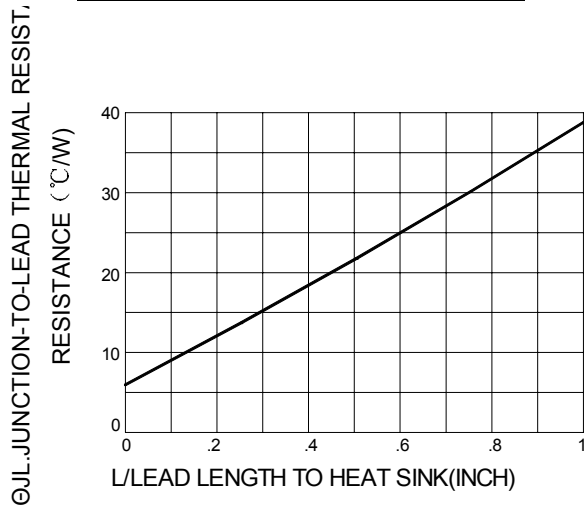

**FIG.4 -- MAXIMUM NON-REPETITIVE SURGE CURRENT**

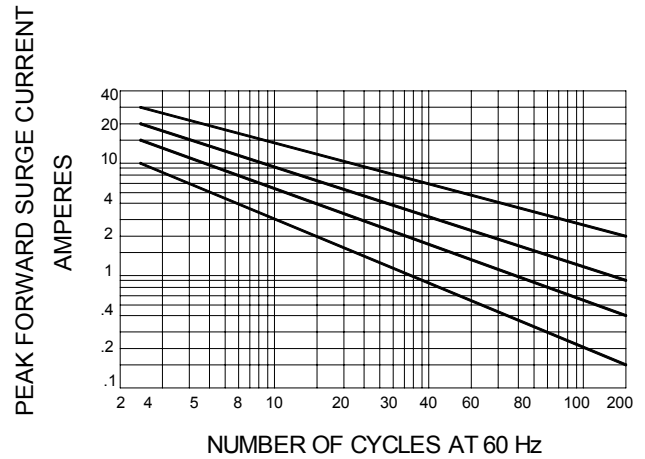

**FIG.5 -- TYPICAL THERMAL RESPONSE**

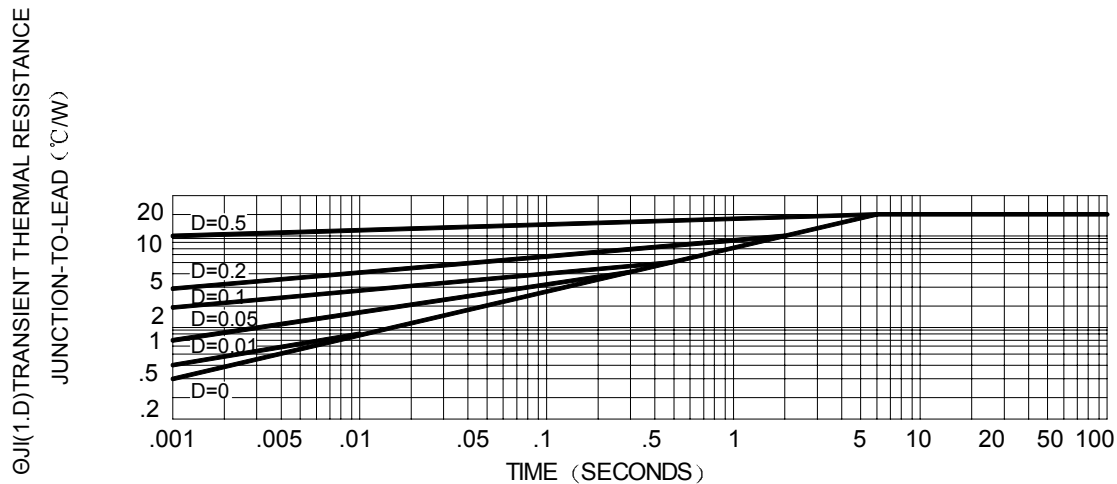

**FIG.6 – PEAK SURGE CURRENT VERSUS PULSE WIDTH**

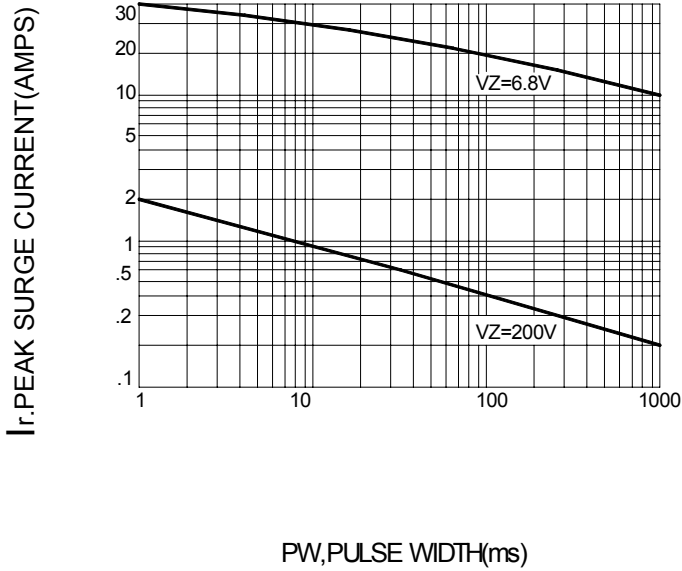

**FIG.7 – ZENER VOLTAGE VERSUS ZENER CURRENT**  
 $V_Z=6.8$  THRU 10 VOLTS

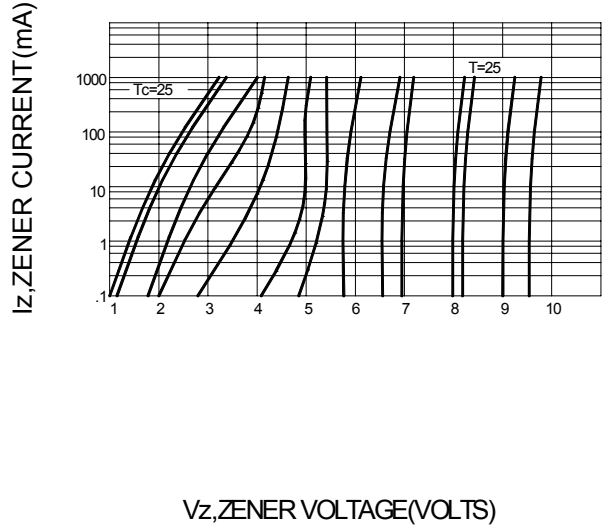

**FIG.8 – ZENER VOLTAGE VERSUS ZENER CURRENT**  
 $V_Z=11$  THRU 75 VOLTS

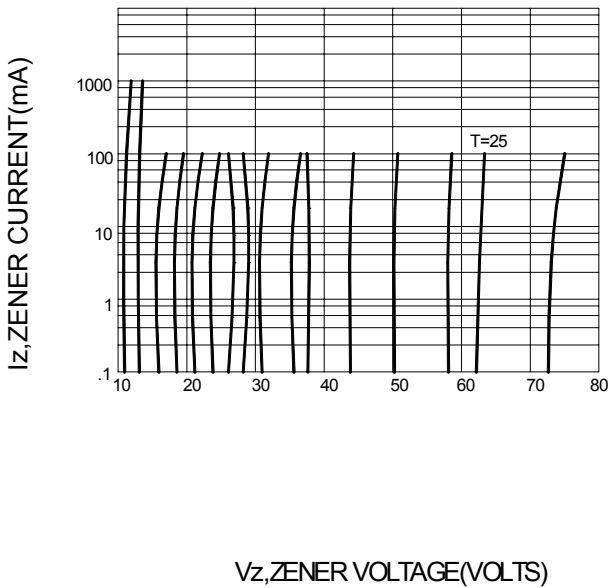

**FIG.9 – ZENER VOLTAGE VERSUS ZENER CURRENT**  
 $V_Z=82$  THRU 200 VOLTS

