

PNP Silicon Planar Transistors

2 N 2906 A  
2 N 2907 A

SIEMENS AKTIENGESELLSCHAFT T-37-17

2 N 2906 A and 2 N 2907 A are epitaxial PNP silicon planar transistors in TO 18 case (18 A 3 DIN 41876). The collector is electrically connected to the case. The transistors are particularly suitable for use as high-speed switches.

Type	Ordering code
2 N 2906 A	Q62702-F408
2 N 2907 A	Q62702-S170

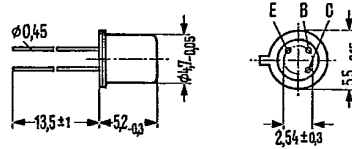

Approx. weight 0.3 g      Dimensions in mm

Maximum ratings

	2 N 2906 A 2 N 2907 A	
Collector-emitter voltage	-V <sub>CEO</sub> 60	V
Collector-base voltage	-V <sub>CBO</sub> 60	V
Emitter-base voltage	-V <sub>EBO</sub> 5	V
Collector current	-I <sub>C</sub> 0.6	A
Junction temperature	T <sub>J</sub> 200	°C
Storage temperature range	T <sub>stg</sub> -65 to +200	°C
Total power dissipation (T <sub>amb</sub> = 25 °C)	P <sub>tot</sub> 0.4	W
Total power dissipation (T <sub>case</sub> = 25 °C)	P <sub>tot</sub> 1.8	W

Thermal resistance

Junction to ambient air	R <sub>thJA</sub> < 438	K/W
Junction to case	R <sub>thJC</sub> < 97	K/W

Static characteristics ( $T_{amb} = 25\text{ }^\circ\text{C}$ )		2 N 2906 A	2 N 2907 A	
Collector-base breakdown voltage ( $-I_C = 10\text{ }\mu\text{A}$ )	$-V_{(BR)CBO}$	> 60	> 60	V
Collector-emitter breakdown voltage ( $-I_C = 10\text{ mA}$ )	$-V_{(BR)CEO}$	> 60	> 60	V
Emitter-base breakdown voltage ( $-I_E = 10\text{ }\mu\text{A}$ )	$-V_{(BR)EBO}$	> 5	> 5	V
Collector-emitter saturation voltage ( $-I_B = 15\text{ mA}; -I_C = 150\text{ mA}$ )	$-V_{CEsat}$	< 0.4	< 0.4	V
( $-I_B = 50\text{ mA}; -I_C = 500\text{ mA}$ )	$-V_{CEsat}$	< 1.6	< 1.6	V
Base-emitter saturation voltage ( $-I_C = 150\text{ mA}; -I_B = 15\text{ mA}$ )	$-V_{BEsat}$	< 1.3	< 1.3	V
( $-I_C = 500\text{ mA}; -I_B = 50\text{ mA}$ )	$-V_{BEsat}$	< 2.6	< 2.6	V
Collector cutoff current ( $-V_{CB} = 50\text{ V}$ )	$-I_{CBO}$	< 10	< 10	nA
( $-V_{CB} = 50\text{ V}; T_{amb} = 150\text{ }^\circ\text{C}$ )	$-I_{CBO}$	< 10	< 10	$\mu\text{A}$
DC current gain ( $-V_{CE} = 10\text{ V}; -I_C = 100\text{ }\mu\text{A}$ )	$h_{FE}$	> 40	> 75	-
( $-V_{CE} = 10\text{ V}; -I_C = 1\text{ mA}$ )	$h_{FE}$	> 40	> 100	-
( $-V_{CE} = 10\text{ V}; -I_C = 10\text{ mA}$ )	$h_{FE}$	> 40	> 100	-
( $-V_{CE} = 10\text{ V}; -I_C = 150\text{ mA}$ )	$h_{FE}$	40 to 120	100 to 300	-
( $-V_{CE} = 10\text{ V}; -I_C = 500\text{ mA}$ )	$h_{FE}$	> 40	> 50	-
<b>Dynamic characteristics (<math>T_{amb} = 25\text{ }^\circ\text{C}</math>)</b>				
Collector-base capacitance ( $-V_{CB} = 10\text{ V}; f = 100\text{ kHz}$ )	$C_{CBO}$	< 8	< 8	pF
Transition frequency ( $-V_{CE} = 20\text{ V}; -I_C = 50\text{ mA}; f = 100\text{ MHz}$ )	$f_T$	> 200	> 200	MHz
<b>Switching times:</b>				
( $-V_{CC} = 30\text{ V}; -I_C = 150\text{ mA};$ $I_{B1}$ approx. $-I_{B2}$ approx. $15\text{ mA}$ )				
Delay time	$t_d$	< 10	< 10	ns
Rise time	$t_r$	< 40	< 40	ns
Storage time	$t_s$	< 80	< 80	ns
Fall time	$t_f$	< 30	< 30	ns

2 N 2906  
 2 N 2907  
 2 N 2906 A  
 2 N 2907 A

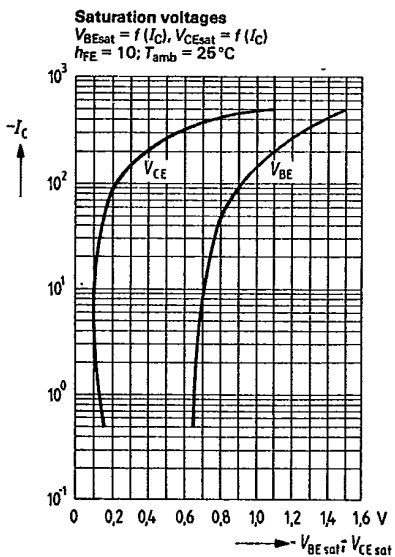
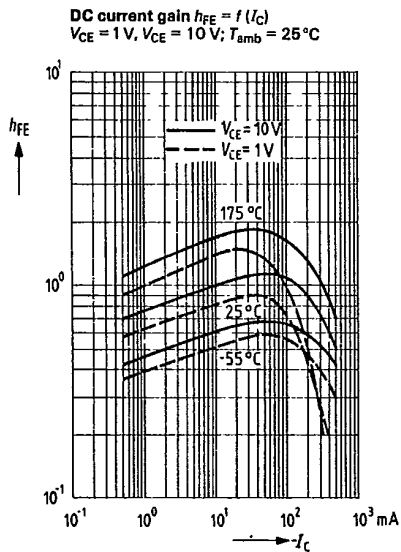
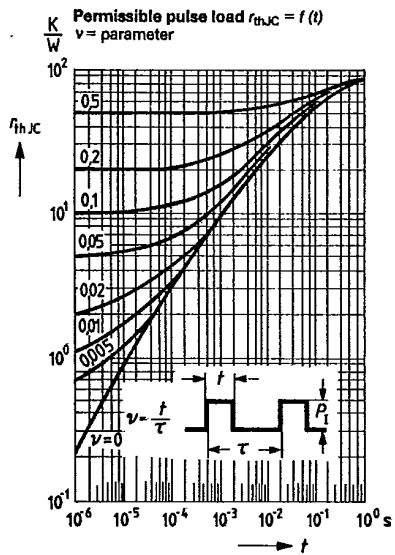
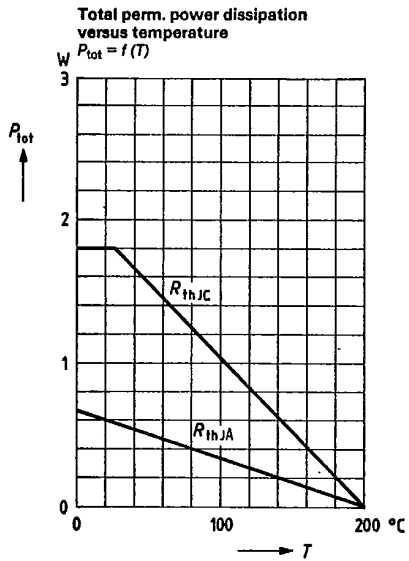

2 N 2906  
 2 N 2907  
 2 N 2906 A  
 2 N 2907 A

SIEMENS AKTIENGESELLSCHAFT

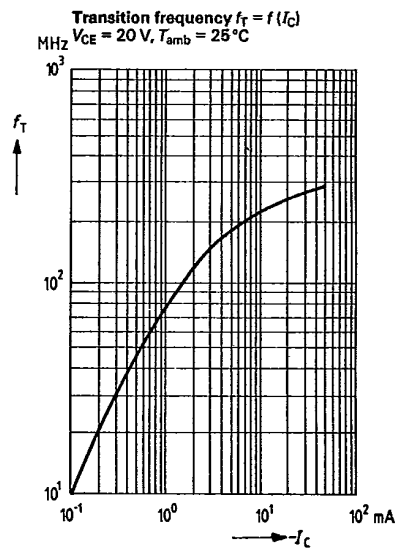
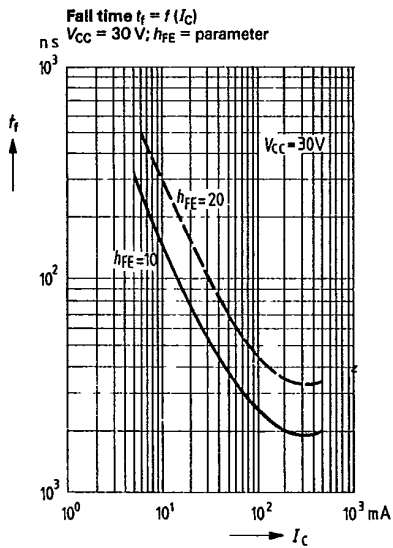
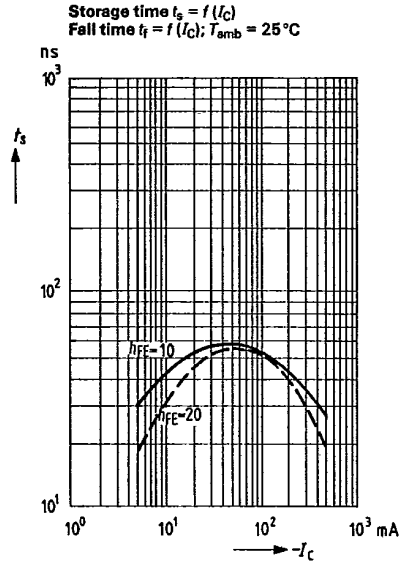
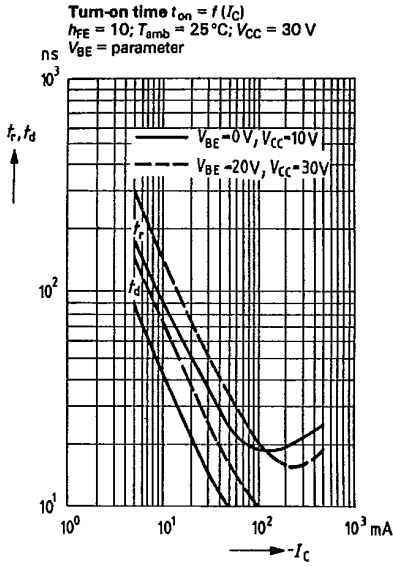

2 N 2906  
2 N 2907  
2 N 2906 A  
2 N 2907 A

SIEMENS AKTIENGESELLSCHAFT

