

SOT-523 Plastic-Encapsulate MOSFET

N-Channel MOSFET

Product Summary

$V_{(BR)DSS}$	$R_{DS(on)MAX}$	I_D
60V	5Ω@10V	115mA
	7Ω@5V	

Features

- High density cell design for Low RDS(on)
- Voltage controlled small signal switch
- Rugged and reliable
- High saturation current capability
- ESD protected

Applications

- DC/DC Converter
- Load Switch for Portable Devices
- Battery Switch

Marking

- K72

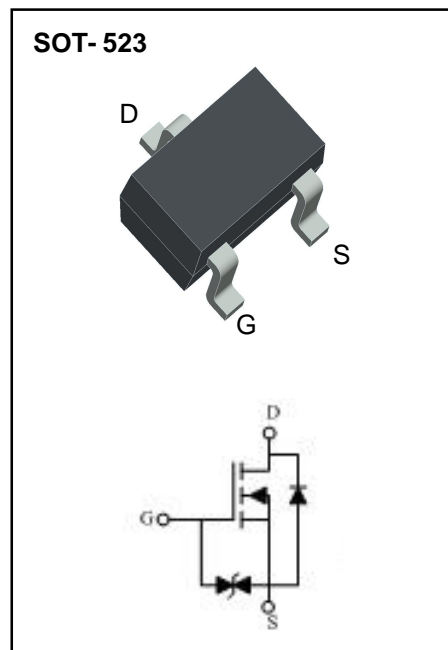

Limiting Values (Absolute Maximum Rating)

Parameter	Symbol	Value	Unit
Drain-Source Voltage	V_{DS}	60	V
Gate-Source Voltage	V_{GS}	±20	V
Continuous Drain Current	I_D	115	mA
Power Dissipation	P_D	0.150	W
Thermal Resistance from Junction to Ambient	$R_{θJA}$	833	°C/W
Junction Temperature	T_J	150	°C
Storage Temperature	T_{STG}	-55~ +150	°C

Electrical Characteristics ($T_A=25^\circ\text{C}$ unless otherwise noted)

Parameter	Symbol	Test Condition	Min	Type	Max	Unit
Static Characteristics						
Drain-source breakdown voltage	$V_{(BR)DSS}$	$V_{GS} = 0V, I_D = 250\mu A$	60			V
Zero gate voltage drain current	I_{DSS}	$V_{DS} = 60V, V_{GS} = 0V$			80	nA
Gate-body leakage current	I_{GSS}	$V_{GS} = \pm 20V, V_{DS} = 0V$			± 10	μA
Gate threshold voltage	$V_{GS(th)}$	$V_{DS} = V_{GS}, I_D = 250\mu A$	1	1.7	2.5	V
On-state drain current	$I_{D(on)}$	$V_{GS}=10V, V_{DS}=7V$	500			mA
Drain-source on-resistance	$R_{DS(on)}$	$V_{GS} = 10V, I_D = 500mA$		1.2	5	Ω
		$V_{GS} = 5V, I_D = 50mA$		1.3	7	
On-state drain-source voltage	$V_{DS(on)}$	$V_{GS}=10V, I_D=500mA$			3.75	V
		$V_{GS}=5V, I_D=50mA$			0.375	
Dynamic characteristics						
Input Capacitance	C_{iss}	$V_{DS}=25V, V_{GS}=0V, f=1MHz$			50	pF
Output Capacitance	C_{oss}				25	pF
Reverse Transfer Capacitance	C_{rss}				5	pF
Switching Characteristics						
Turn-on delay time	$t_{d(on)}$	$V_{DD}=25V, R_L=50\Omega$			20	ns
Turn-off delay time	$t_{d(off)}$	$I_D=500mA, V_{GEN}=10V, R_G=25\Omega$			40	ns
Source-Drain Diode characteristics						
Diode Forward voltage	V_{DS}	$V_{GS} = 0V, I_S = 115mA$	0.55		1.2	V

Typical Characteristics

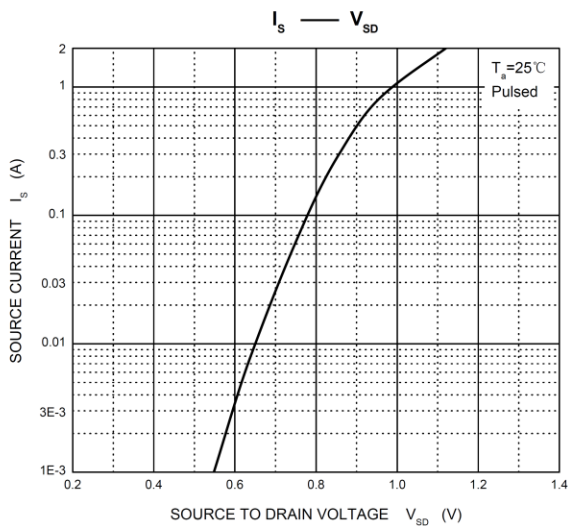
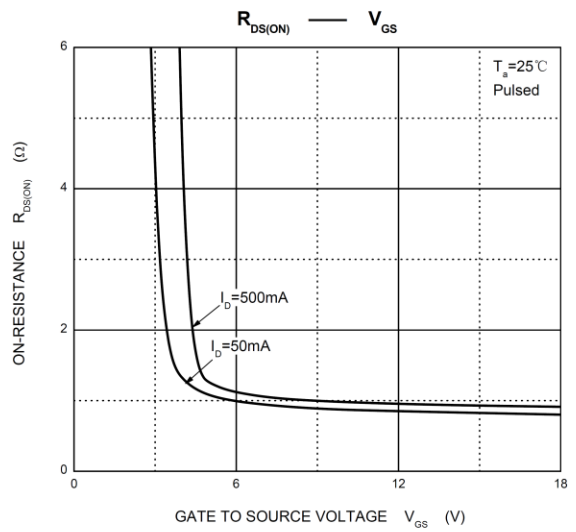
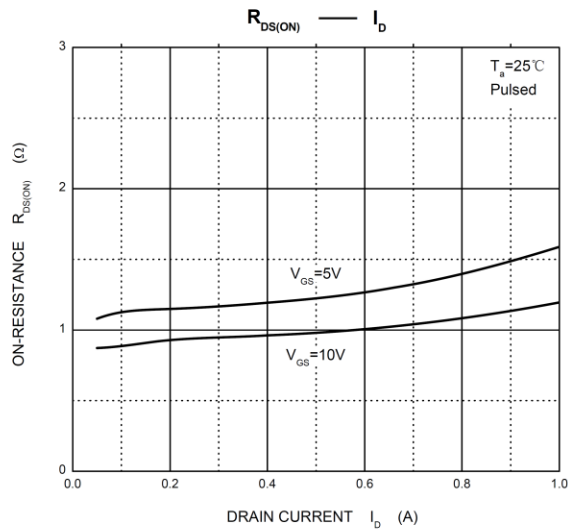
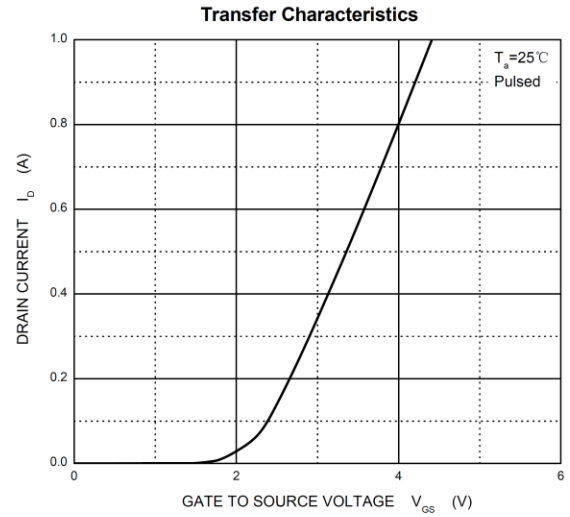
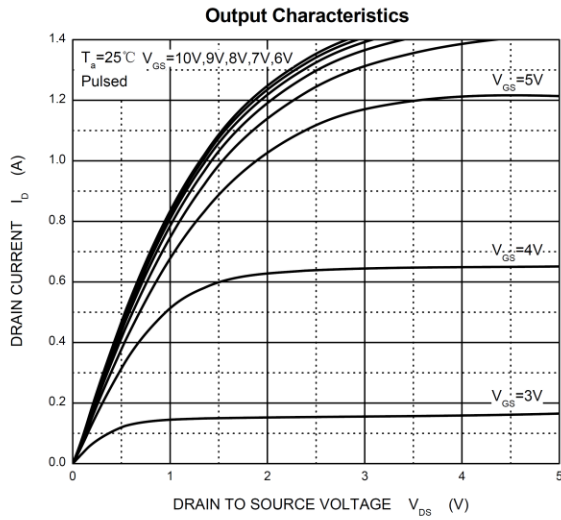

SOT-523 Package Outline Dimensions

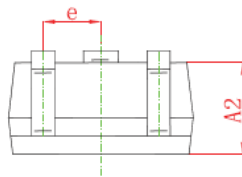
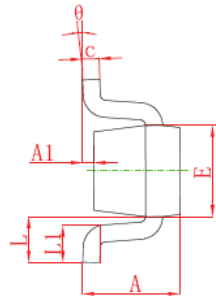
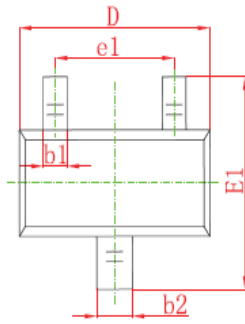

Symbol	Dimensions In Millimeters	
	Min	Max
A	0.700	0.900
A1	0.000	0.100
A2	0.700	0.800
b1	0.150	0.250
b2	0.250	0.350
C	0.100	0.200
D	1.500	1.700
E	0.700	0.900
E1	1.450	1.750
e	0.500 TYP	
e1	0.900	1.100
L	0.400 REF	
L1	0.260	0.460
θ	0°	8°

SOT-523 Suggested Pad Layout

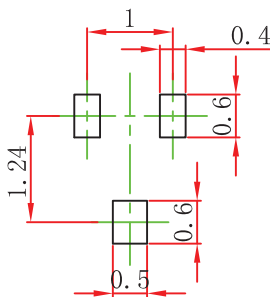

Note:

1. Controlling dimension: in millimeters.
2. General tolerance: $\pm 0.05\text{mm}$.
3. The pad layout is for reference purposes only.

NOTICE

JSHD reserve the right to make modifications, enhancements, improvements, corrections or other changes without further notice to any product herein. JSHD does not assume any liability arising out of the application or use of any product described herein.

SOT-523 Tape and reel

SOT-523 Embossed Carrier Tape

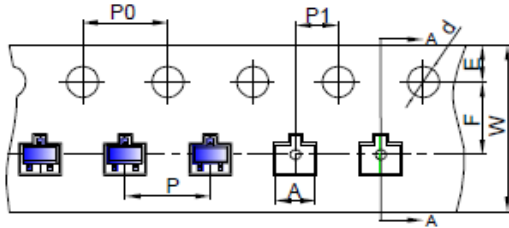

Packaging Description:

SOT-523 parts are shipped in tape. The carrier tape is made from a dissipative (carbon filled) polycarbonate resin. The cover tape is a multilayer film (Heat Activated Adhesive in nature) primarily composed of polyester film, adhesive layer, sealant, and anti-static sprayed agent. These reeled parts in standard option are shipped with 3,000 units per 7" or 17.8cm diameter reel. The reels are clear in color and is made of polystyrene plastic (anti-static coated).

Dimensions are in millimeter										
Pkg type	A	B	C	d	E	F	P0	P	P1	W
SOT-523	1.85	1.85	0.875	Ø1.50	1.75	3.50	4.00	4.00	2.00	8.00

SOT-523 Tape Leader and Trailer

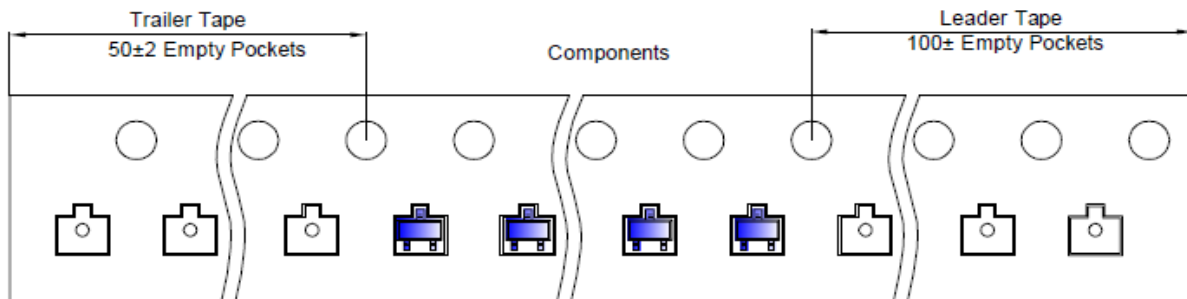

SOT-523 Reel

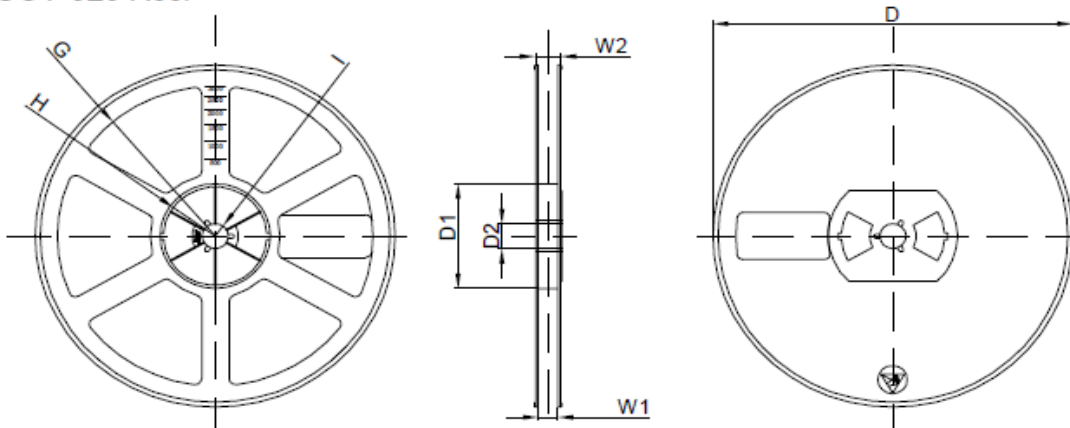

Dimensions are in millimeter								
Reel Option	D	D1	D2	G	H	I	W1	W2
7" Dia	Ø178.00	54.40	13.00	R78.00	R25.60	R6.50	9.50	12.30

REEL	Reel Size	Box	Box Size(mm)	Carton	Carton Size(mm)	G.W.(kg)
3000 pcs	7 inch	30,000 pcs	203×203×195	120,000 pcs	438×438×220	