

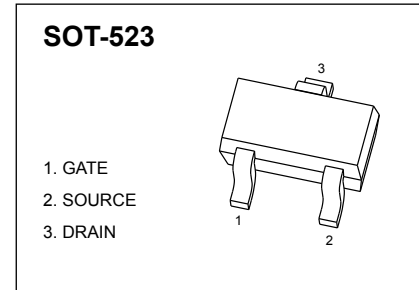

SOT-523 Plastic-Encapsulate MOSFETS

2N7002T MOSFET (N-Channel)

$V_{(BR)DSS}$	$R_{DS(on)MAX}$	I_D
60V	5Ω@10V	115mA
	7Ω@5V	



FEATURE

- High density cell design for low $R_{DS(ON)}$
- Voltage controlled small signal switch
- Rugged and reliable
- High saturation current capability

APPLICATION

- Load Switch for Portable Devices
- DC/DC Converter

MARKING

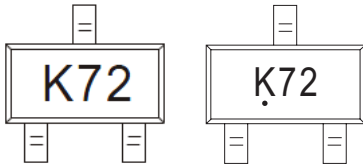

K72= Device Code

Solid dot = Green molding compound device, if none, the normal device.

Equivalent Circuit

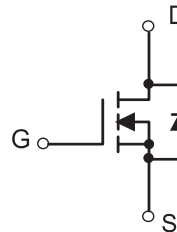

MAXIMUM RATINGS ($T_a=25^\circ\text{C}$ unless otherwise noted)

Symbol	Parameter	Value	Unit
V_{DS}	Drain-Source voltage	60	V
V_{GS}	Gate-Source voltage	±20	V
I_D	Drain Current	115	mA
P_D	Power Dissipation	150	mW
$R_{\theta JA}$	Thermal Resistance from Junction to Ambient	833	$^\circ\text{C/W}$
T_J	Junction Temperature	150	$^\circ\text{C}$
T_{stg}	Storage Temperature	-55~+150	$^\circ\text{C}$

MOSFET ELECTRICAL CHARACTERISTICS

$T_a=25\text{ }^\circ\text{C}$ unless otherwise specified

Parameter	Symbol	Test conditions	Min	Typ	Max	Unit
Drain-Source Breakdown Voltage	$V_{(BR)DSS}$	$V_{GS}=0\text{ V}, I_D=250\text{ }\mu\text{A}$	60			V
Gate-Threshold Voltage	$V_{th(GS)}$	$V_{DS}=V_{GS}, I_D=250\text{ }\mu\text{A}$	1		2.5	
Gate-body Leakage	I_{GSS}	$V_{DS}=0\text{ V}, V_{GS}=\pm 20\text{ V}$			± 80	nA
Zero Gate Voltage Drain Current	I_{DSS}	$V_{DS}=60\text{ V}, V_{GS}=0\text{ V}$			80	nA
On-state Drain Current	$I_{D(ON)}$	$V_{GS}=10\text{ V}, V_{DS}=7\text{ V}$	500			mA
Drain-Source On-Resistance	$R_{DS(on)}$	$V_{GS}=10\text{ V}, I_D=500\text{ mA}$			5	Ω
		$V_{GS}=5\text{ V}, I_D=50\text{ mA}$			7	
Forward Trans conductance	g_{fs}	$V_{DS}=10\text{ V}, I_D=200\text{ mA}$	80			ms
Drain-source on-voltage	$V_{DS(on)}$	$V_{GS}=10\text{ V}, I_D=500\text{ mA}$			3.75	V
		$V_{GS}=5\text{ V}, I_D=50\text{ mA}$			0.375	V
Diode Forward Voltage	V_{SD}	$I_S=115\text{ mA}, V_{GS}=0\text{ V}$	0.55		1.2	V
Input Capacitance	C_{iss}	$V_{DS}=25\text{ V}, V_{GS}=0\text{ V}, f=1\text{ MHz}$			50	pF
Output Capacitance	C_{oss}				25	
Reverse Transfer Capacitance	C_{rss}				5	

SWITCHING TIME

Turn-on Time	$t_{d(on)}$	$V_{DD}=25\text{ V}, R_L=50\Omega$			20	ns
Turn-off Time	$t_{d(off)}$	$I_D=500\text{ mA}, V_{GEN}=10\text{ V}$ $R_G=25\text{ }\Omega$			40	

Typical Characteristics

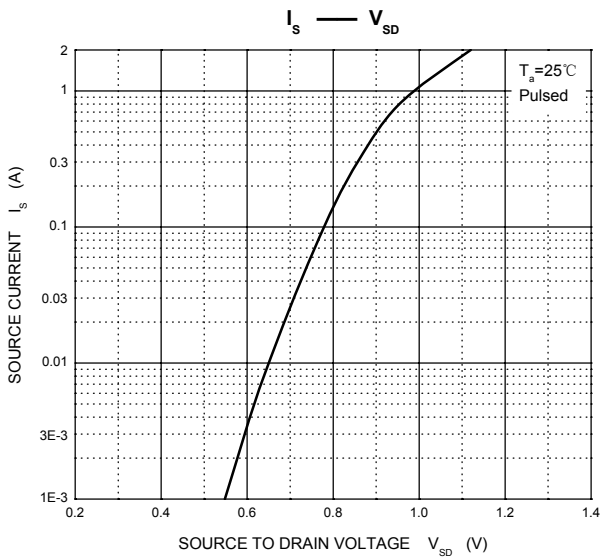
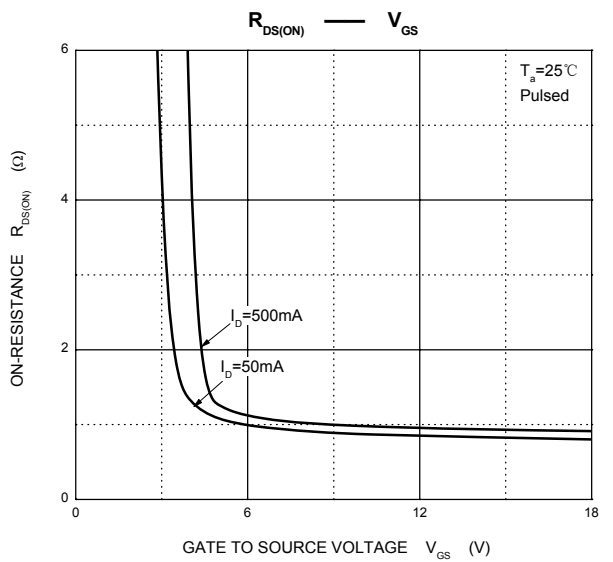
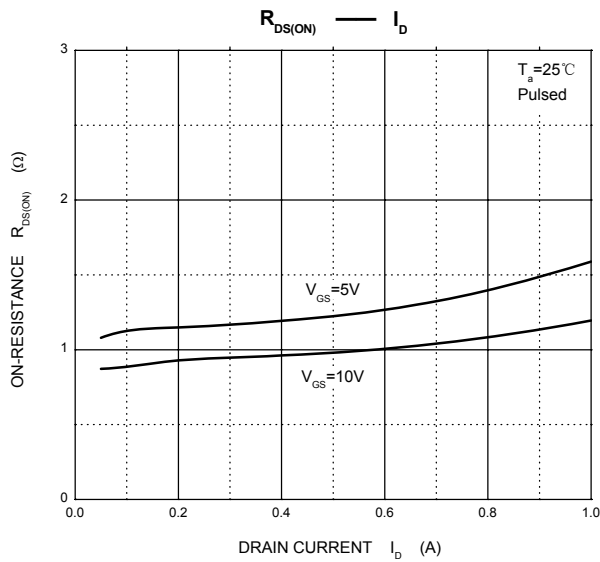
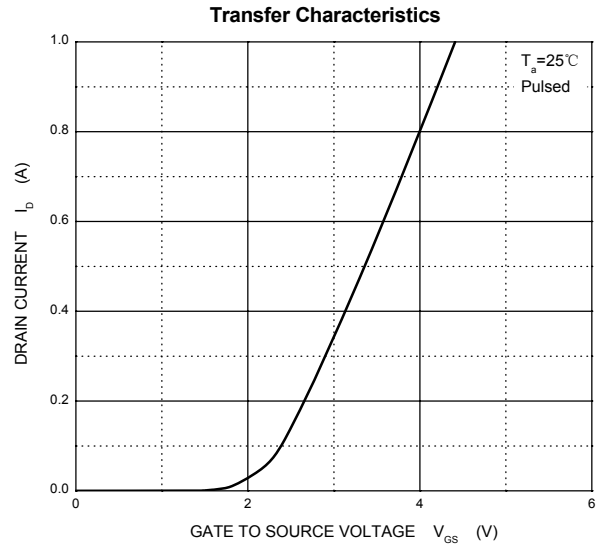
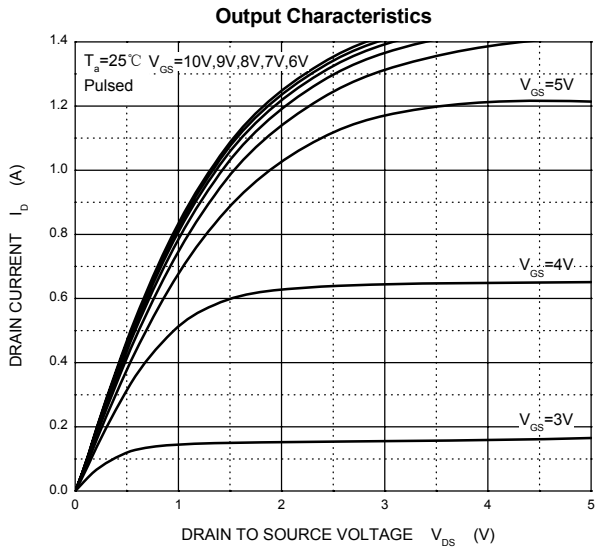

SOT-523 Package Outline Dimensions

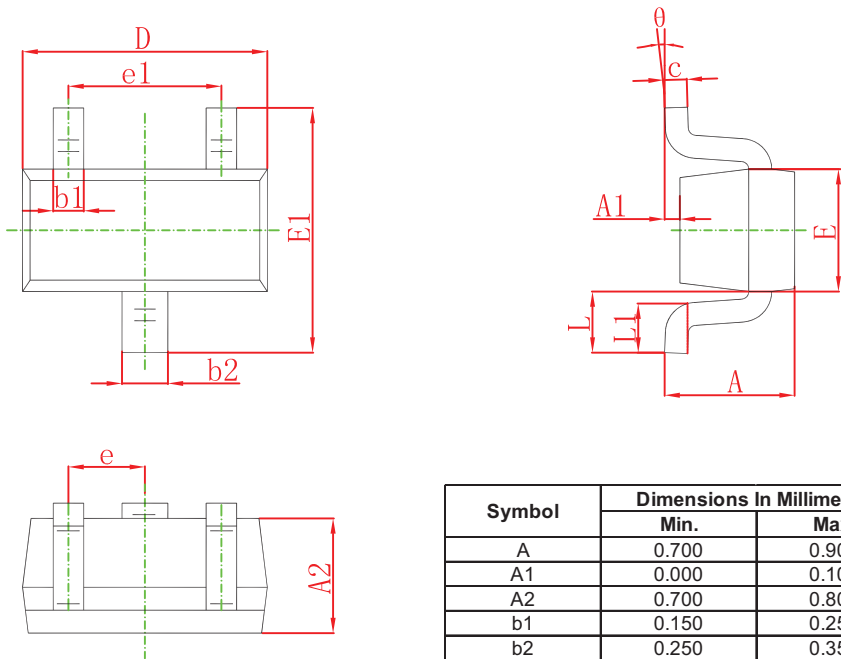

Symbol	Dimensions In Millimeters		Dimensions In Inches	
	Min.	Max.	Min.	Max.
A	0.700	0.900	0.028	0.035
A1	0.000	0.100	0.000	0.004
A2	0.700	0.800	0.028	0.031
b1	0.150	0.250	0.006	0.010
b2	0.250	0.350	0.010	0.014
c	0.100	0.200	0.004	0.008
D	1.500	1.700	0.059	0.067
E	0.700	0.900	0.028	0.035
E1	1.450	1.750	0.057	0.069
e	0.500 TYP.		0.020 TYP.	
e1	0.900	1.100	0.035	0.043
L	0.400 REF.		0.016 REF.	
L1	0.260	0.460	0.010	0.018
θ	0°	8°	0°	8°

SOT-523 Suggested Pad Layout

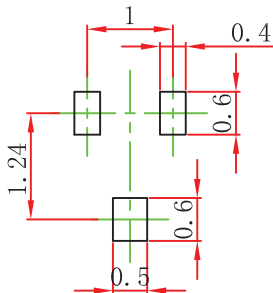

- Note:
1. Controlling dimension: in millimeters.
 2. General tolerance: ± 0.05 mm.
 3. The pad layout is for reference purposes only.

NOTICE

JCET reserve the right to make modifications, enhancements, improvements, corrections or other changes without further notice to any product herein. JCET does not assume any liability arising out of the application or use of any product described herein.

SOT-523 Tape and Reel

SOT-523 Embossed Carrier Tape

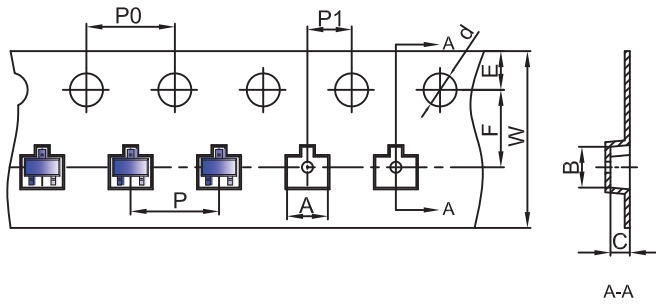

Packaging Description:

SOT-523 parts are shipped in tape. The carrier tape is made from a dissipative (carbon filled) polycarbonate resin. The cover tape is a multilayer film (Heat Activated Adhesive in nature) primarily composed of polyester film, adhesive layer, sealant, and anti-static sprayed agent. These reeled parts in standard option are shipped with 3,000 units per 7" or 17.8cm diameter reel. The reels are clear in color and is made of polystyrene plastic (anti-static coated).

Dimensions are in millimeter										
Pkg type	A	B	C	d	E	F	P0	P	P1	W
SOT-523	1.85	1.85	0.875	Ø1.50	1.75	3.50	4.00	4.00	2.00	8.00

SOT-523 Tape Leader and Trailer

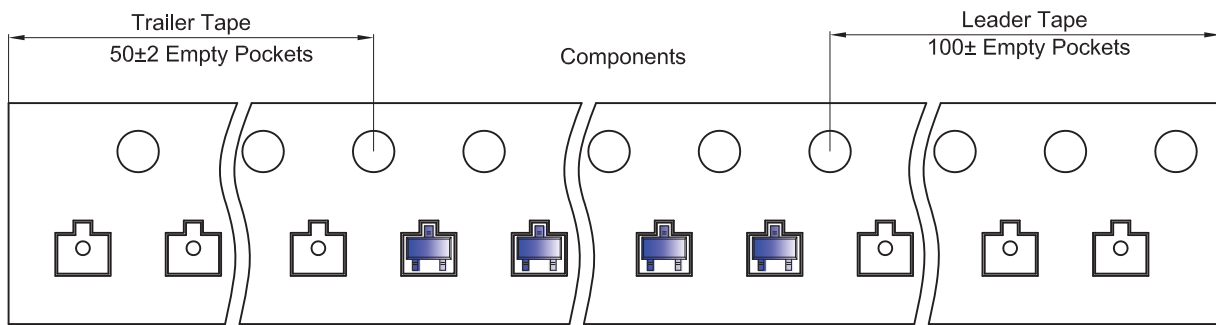

SOT-523 Reel

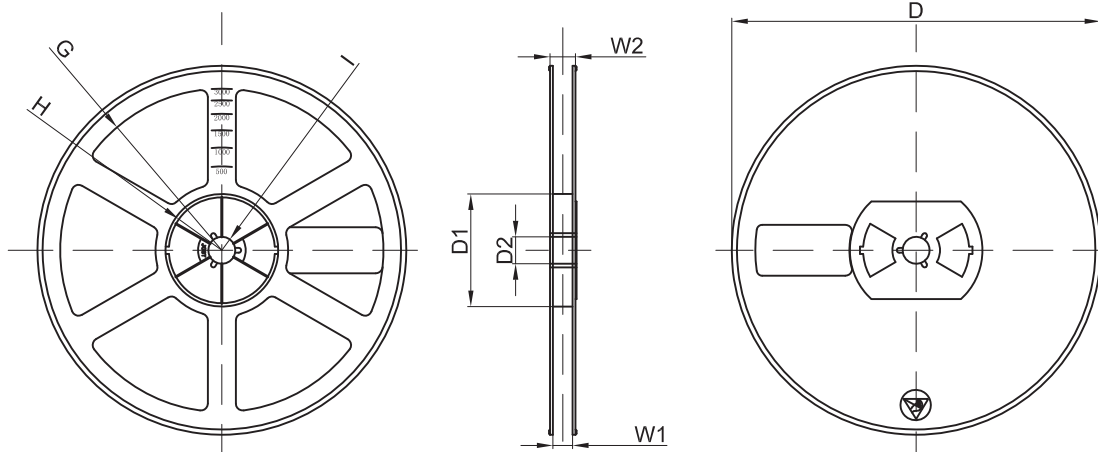

Dimensions are in millimeter								
Reel Option	D	D1	D2	G	H	I	W1	W2
7" Dia	Ø178.00	54.40	13.00	R78.00	R25.60	R6.50	9.50	12.30

REEL	Reel Size	Box	Box Size(mm)	Carton	Carton Size(mm)	G.W.(kg)
3000 pcs	7 inch	45,000 pcs	203×203×195	180,000 pcs	438×438×220	