



2SB688

PNP PLANAR SILICON TRANSISTOR

**AUDIO POWER AMPLIFIER
DC TO DC CONVERTER**

- High Current Capability
- High Power Dissipation
- Complementary to 2SD718

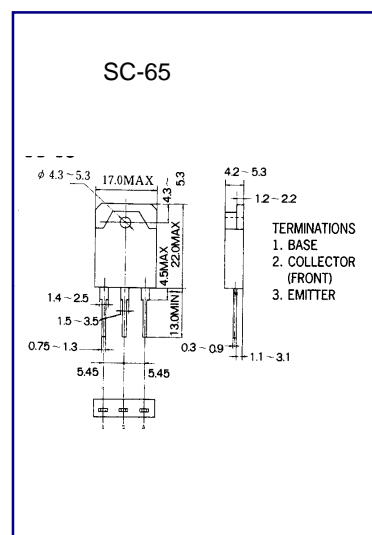

ABSOLUTE MAXIMUM RATING (Ta=25°C)

Characteristic	Symbol	Rating	Unit
Collector-Base Voltage	VCBO	-160	V
Collector-Emitter Voltage	VCEO	-120	V
Emitter-Base voltage	VEBO	-6	V
Collector Current (DC)	IC	-8	A
Collector Dissipation	PC	80	W
Junction Temperature	Tj	150	°C
Storage Temperature	Tstg	-55~150	°C

ELECTRICAL CHARACTERISTICS (Ta=25°C)

Characteristic	Symbol	Test Condition	Min	Typ	Max	Unit
Collector Base Breakdown Voltage	BVCBO	IC=-5 mA IE=0	-160			V
Collector Emitter Breakdown Voltage	BVCEO	IC=-10 mA	-120			V
Emitter Base Breakdown Voltage	BVEBO	RBE=∞	-6			V
Collector Cutoff Current	ICBO	IE=-5mA IC=0			-0.1	mA
Emitter Cutoff Current	IEBO	VCB=-60V IE=0			-0.1	mA
*DC Current Gain	hFE1	VEB=-4V IC=0	55		160	
DC Current Gain	hFE2	VCE=-5V IC=-1A	50			
Collector- Emitter Saturation Voltage	VCE(sat)	VCE=-5V IC=-3A IB=-0.3A			-1.5	V