

SILICON TRANSISTORS

2SC2148, 2SC2149

MICROWAVE LOW NOISE AMPLIFIER NPN SILICON EPITAXIAL TRANSISTOR

DESCRIPTION

The 2SC2148, 2SC2149 are economical microwave transistors encapsulated into new hermetic stripline packages, "micro X". These are designed for small signal amplifier, low noise amplifier, and oscillator applications in the L to C band, and CML circuit use.

FEATURES

2SC2148 NF: 2.1 dB TYP. @f = 500 MHz

2SC2149 NF: 2.6 dB TYP. @f = 2.0 GHz

PACKAGE DIMENSIONS (Unit : mm)

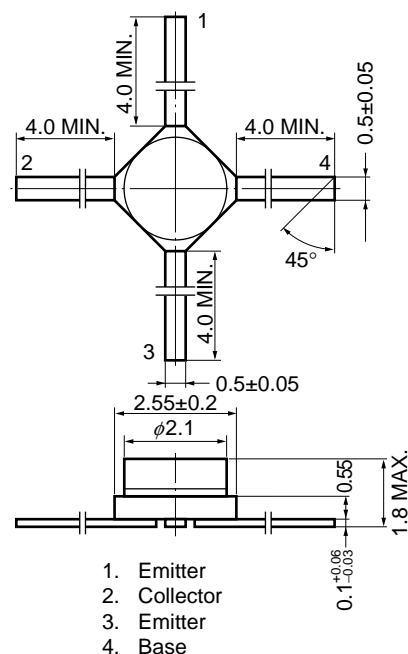

Derating curves of the 2SC2148, 2SC2149.

The maximum junction temperature of these transistors is allowed up to 200 °C, but the ambient or storage temperature is limited to 150 °C. The operating junction temperature is estimated with power consumption (P_T) and thermal resistance mentioned on these derating curves.

The information in this document is subject to change without notice.

2SC2148

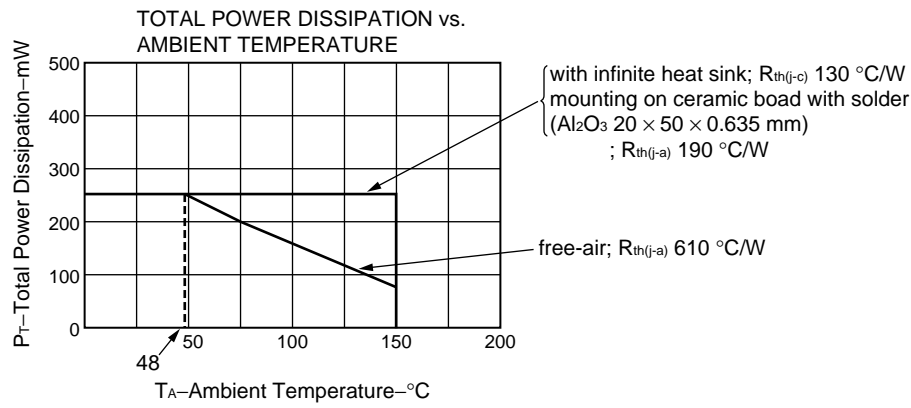

2SC2149

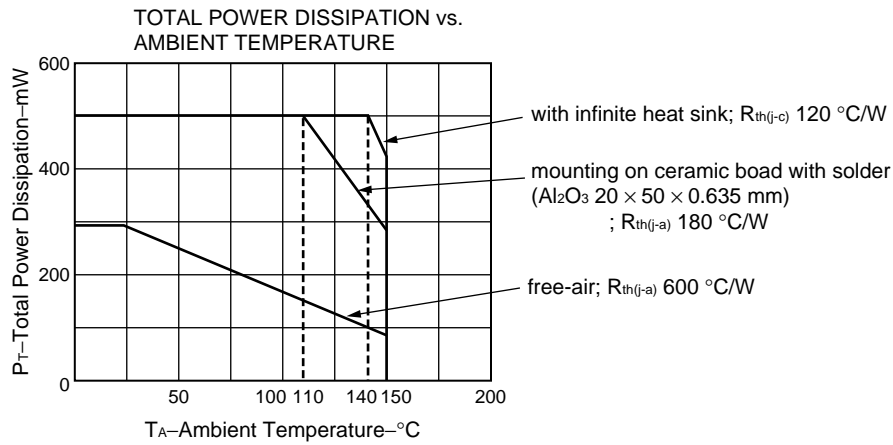

2SC2148

ABSOLUTE MAXIMUM RATINGS (T_A = 25 °C)

Collector to Base Voltage	V _{CB0}	30	V
Collector to Emitter Voltage	V _{CEO}	14	V
Emitter to Base Voltage	V _{EBO}	3.0	V
Collector Current	I _c	50	mA
Total Power Dissipation	P _{T(T_A = 48 °C)}	250	mW
Total Power Dissipation	P _{T(T_C = 150 °C)}	250	mW
Junction Temperature	T _j	200	°C
Storage Temperature	T _{stg}	-65 to +150	°C

ELECTRICAL CHARACTERISTICS (T_A = 25 °C)

CHARACTERISTIC	SYMBOL	MIN.	TYP.	MAX.	UNIT	TEST CONDITIONS
Collector Cutoff Current	I _{CB0}			0.1	μA	V _{CB} = 15 V, I _E = 0
Emitter Cutoff Current	I _{EBO}			0.1	μA	V _{EB} = 2.0 V, I _C = 0
DC Current Gain	h _{FE}	30	80	200		V _{CE} = 10 V, I _C = 10 mA
Gain Bandwidth Product	f _r		3.0		GHz	V _{CE} = 10 V, I _C = 10 mA
Output Capacitance *	C _{ob}		0.55		pF	V _{CB} = 10 V, I _E = 0, f = 1.0 MHz
Insertion Gain	S _{21e} ²	7.5	9.3		dB	V _{CE} = 10 V, I _C = 10 mA, f = 1.0 GHz
Noise Figure	NF		2.1	3.5	dB	V _{CE} = 10 V, I _C = 3.0 mA, f = 500 MHz
Maximum Available Gain	MAG		13.3		dB	V _{CE} = 10 V, I _C = 10 mA, f = 1.0 GHz

* The emitter terminal should be connected to the guard terminal of the three-terminal capacitance bridge.

TYPICAL CHARACTERISTICS (T_A = 25 °C)

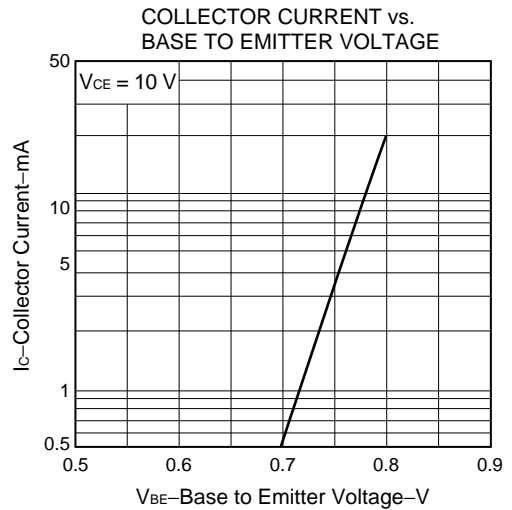
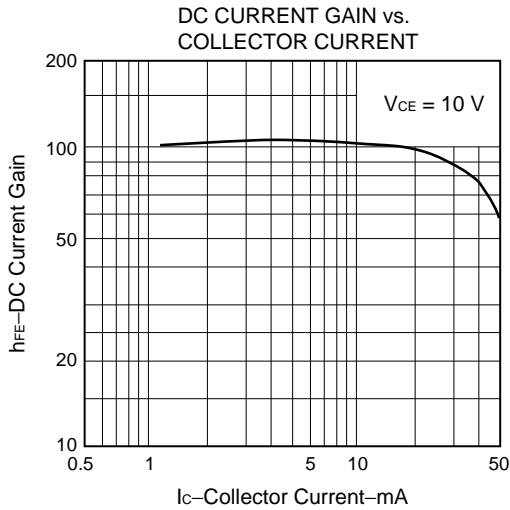

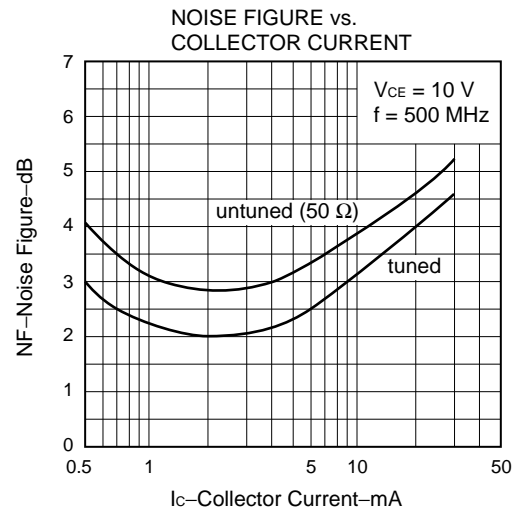
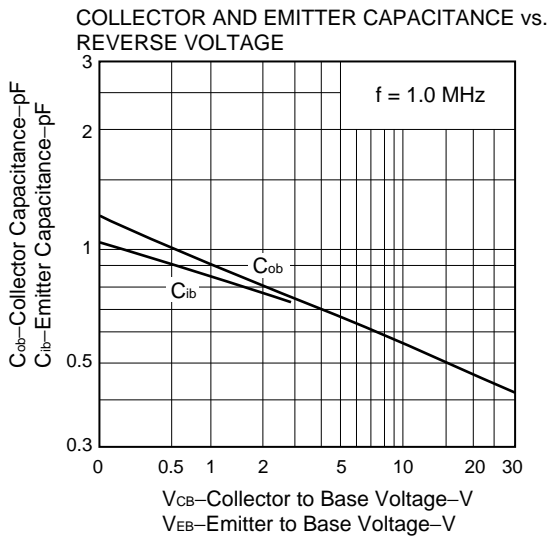
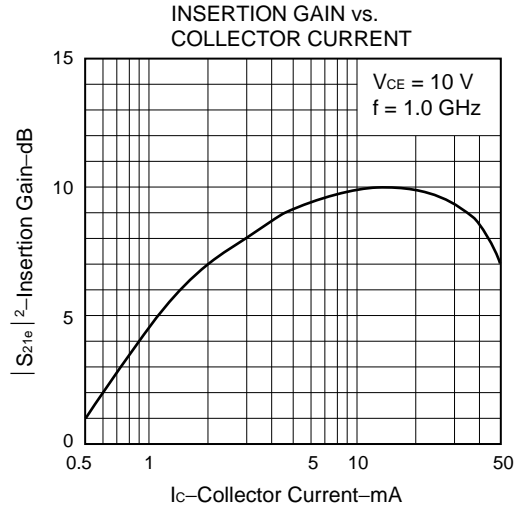
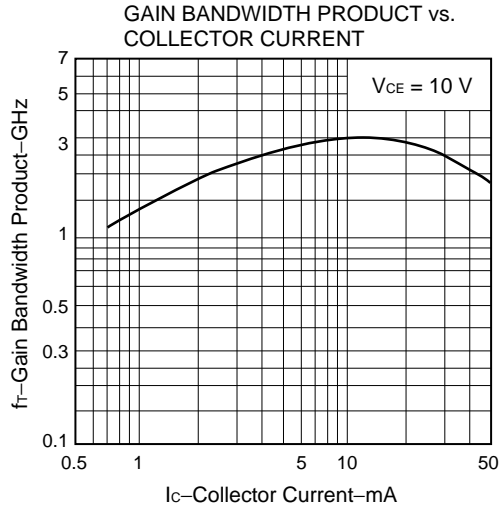

2SC2149

ABSOLUTE MAXIMUM RATINGS (T_A = 25 °C)

Collector to Base Voltage	V _{CB0}	25	V
Collector to Emitter Voltage	V _{CEO}	12	V
Emitter to Base Voltage	V _{EBO}	3.0	V
Collector Current	I _c	70	mA
Total Power Dissipation	P _{T(T_A = 25 °C)}	290	mW
Total Power Dissipation	P _{T(T_C = 140 °C)}	500	mW
Junction Temperature	T _j	200	°C
Storage Temperature	T _{stg}	-65 to +150	°C

ELECTRICAL CHARACTERISTICS (T_A = 25 °C)

CHARACTERISTIC	SYMBOL	MIN.	TYP.	MAX.	UNIT	TEST CONDITIONS	
Collector Cutoff Current	I _{CB0}			0.1	μA	V _{CB} = 15 V, I _E = 0	
Emitter Cutoff Current	I _{EBO}			0.1	μA	V _{EB} = 2.0 V, I _c = 0	
DC Current Gain	h _{FE}	30	70	200		V _{CE} = 10 V, I _c = 20 mA	
Gain Bandwidth Product	f _r		5.0		GHz	V _{CE} = 10 V, I _c = 20 mA	
Output Capacitance *	C _{ob}		0.6		pF	V _{CB} = 10 V, I _E = 0, f = 1.0 MHz	
Insertion Gain	S _{21e} ²		12.7		dB	V _{CE} = 10 V, I _c = 20 mA	f = 1.0 GHz
		5.0	6.7		dB		f = 2.0 GHz
Noise Figure	NF		1.7		dB	V _{CE} = 10 V, I _c = 5.0 mA	f = 1.0 GHz
			2.6	4.0	dB		f = 2.0 GHz
Maximum Available Gain	MAG		17		dB	V _{CE} = 10 V, I _c = 20 mA	f = 1.0 GHz
			11		dB		f = 2.0 GHz

* The emitter terminal should be connected to the guard terminal of the three-terminal capacitance bridge.

TYPICAL CHARACTERISTICS (T_A = 25 °C)

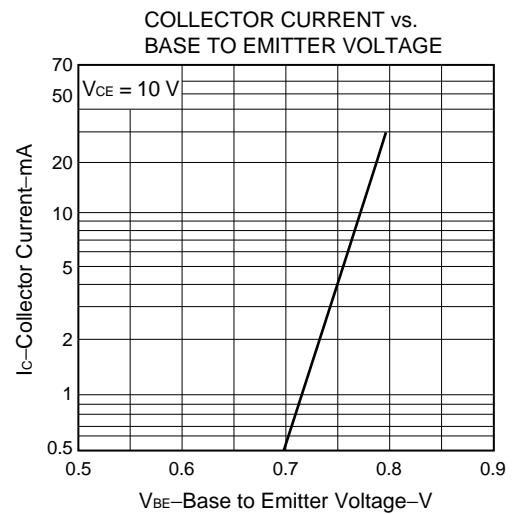
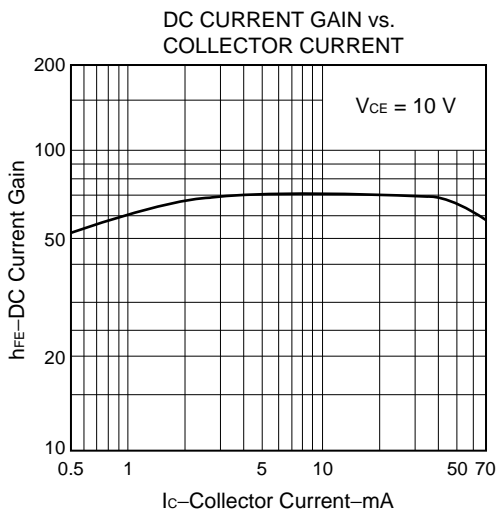

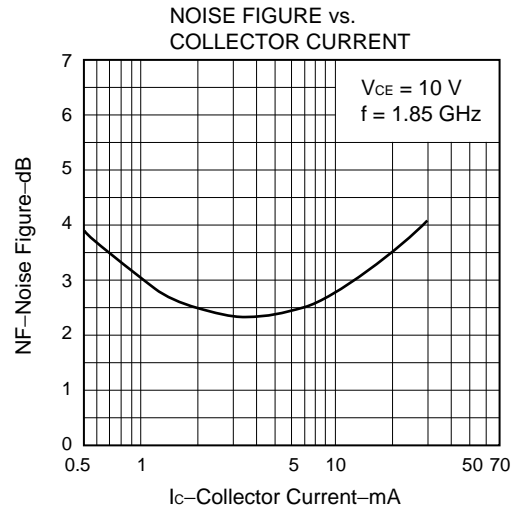
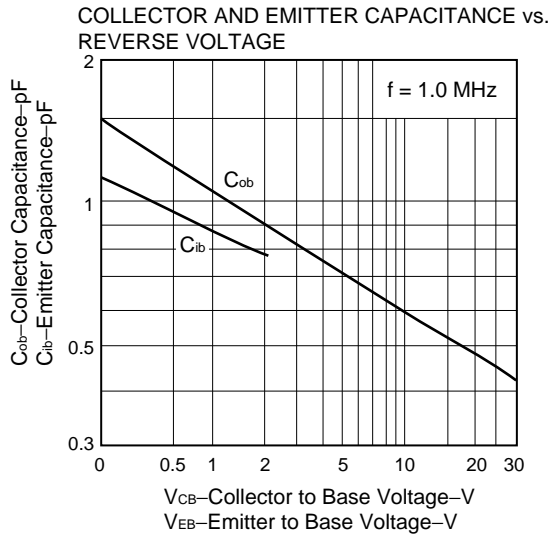
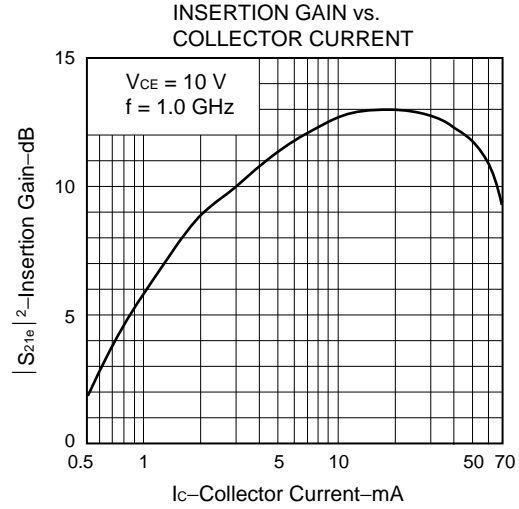
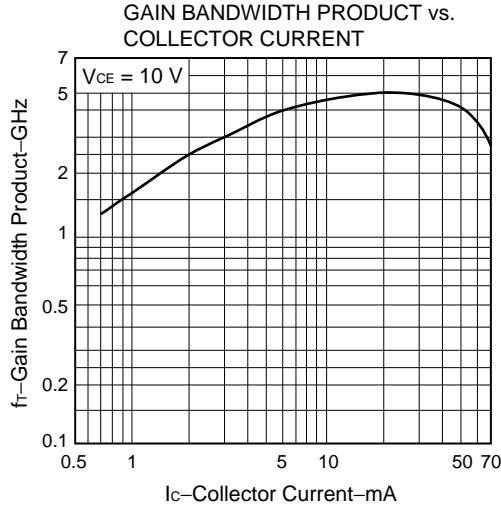

[MEMO]

No part of this document may be copied or reproduced in any form or by any means without the prior written consent of NEC Corporation. NEC Corporation assumes no responsibility for any errors which may appear in this document.

NEC Corporation does not assume any liability for infringement of patents, copyrights or other intellectual property rights of third parties by or arising from use of a device described herein or any other liability arising from use of such device. No license, either express, implied or otherwise, is granted under any patents, copyrights or other intellectual property rights of NEC Corporation or others.

While NEC Corporation has been making continuous effort to enhance the reliability of its semiconductor devices, the possibility of defects cannot be eliminated entirely. To minimize risks of damage or injury to persons or property arising from a defect in an NEC semiconductor device, customers must incorporate sufficient safety measures in its design, such as redundancy, fire-containment, and anti-failure features.

NEC devices are classified into the following three quality grades:

"Standard", "Special", and "Specific". The Specific quality grade applies only to devices developed based on a customer designated "quality assurance program" for a specific application. The recommended applications of a device depend on its quality grade, as indicated below. Customers must check the quality grade of each device before using it in a particular application.

Standard: Computers, office equipment, communications equipment, test and measurement equipment, audio and visual equipment, home electronic appliances, machine tools, personal electronic equipment and industrial robots

Special: Transportation equipment (automobiles, trains, ships, etc.), traffic control systems, anti-disaster systems, anti-crime systems, safety equipment and medical equipment (not specifically designed for life support)

Specific: Aircrafts, aerospace equipment, submersible repeaters, nuclear reactor control systems, life support systems or medical equipment for life support, etc.

The quality grade of NEC devices is "Standard" unless otherwise specified in NEC's Data Sheets or Data Books. If customers intend to use NEC devices for applications other than those specified for Standard quality grade, they should contact an NEC sales representative in advance.

Anti-radioactive design is not implemented in this product.