



SANYO Semiconductors

DATA SHEET

An ON Semiconductor Company

2SC5374A — NPN Epitaxial Planar Silicon Transistor VHF to UHF Band OSC, High-Frequency Amplifier Applications

Features

- High gain : $|S_{21e}|^2 = 10.5\text{dB typ (f=1GHz)}$
- High cut-off frequency : $f_T = 5.2\text{GHz typ}$

Specifications

Absolute Maximum Ratings at $T_a = 25^\circ\text{C}$

Parameter	Symbol	Conditions	Ratings	Unit
Collector-to-Base Voltage	V_{CBO}		20	V
Collector-to-Emitter Voltage	V_{CEO}		10	V
Emitter-to-Base Voltage	V_{EBO}		2	V
Collector Current	I_C		100	mA
Collector Dissipation	P_C		100	mW
Junction Temperature	T_j		150	$^\circ\text{C}$
Storage Temperature	T_{stg}		-55 to +150	$^\circ\text{C}$

Package Dimensions

unit : mm (typ)

7027A-002

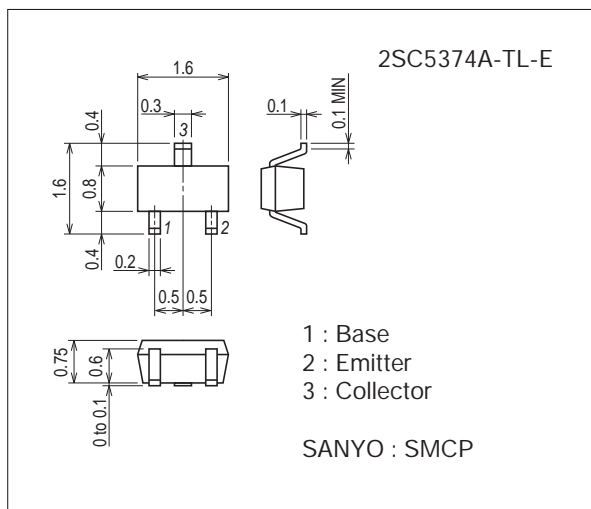

Product & Package Information

- Package : SMCP
- JEITA, JEDEC : SC-75, SOT-416
- Minimum Packing Quantity : 3,000 pcs./reel

Packing Type: TL

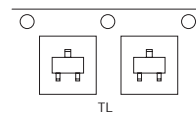

Marking

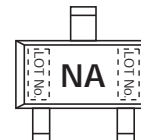

Electrical Connection

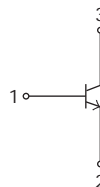

2SC5374A

Electrical Characteristics at Ta=25°C

Parameter	Symbol	Conditions	Ratings			Unit
			min	typ	max	
Collector Cutoff Current	I_{CBO}	$V_{CB}=10V, I_E=0A$			1.0	μA
Emitter Cutoff Current	I_{EBO}	$V_{EB}=1V, I_C=0A$			10	μA
DC Current Gain	h_{FE1}	$V_{CE}=3V, I_C=7mA$	110		180	
	h_{FE2}	$V_{CE}=3V, I_C=30mA$	100			
Gain-Bandwidth Product	f_T	$V_{CE}=3V, I_C=7mA$	3	5.2		GHz
Output Capacitance	C_{ob}	$V_{CB}=3V, f=1MHz$		1.0	1.5	pF
Reverse Transfer Capacitance	C_{re}			0.7		pF
Forward Transfer Gain	$ S_{21e} ^2$	$V_{CE}=3V, I_C=7mA, f=1GHz$	8	10.5		dB
Noise Figure	NF	$V_{CE}=3V, I_C=7mA, f=1GHz$		1.4	2.5	dB

Ordering Information

Device	Package	Shipping	memo
2SC5374A-TL-E	SMCP	3,000pcs./reel	Pb Free

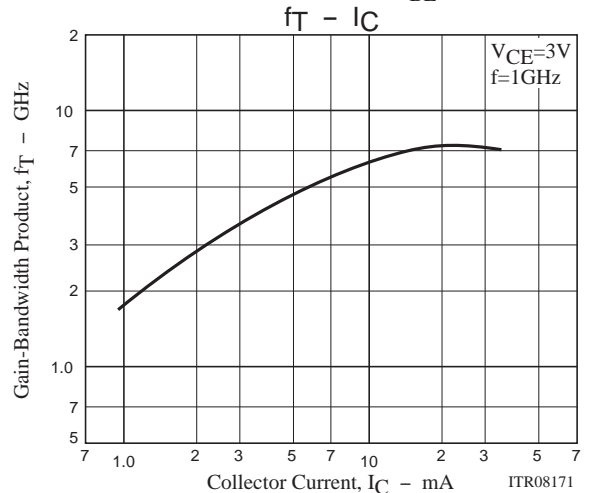
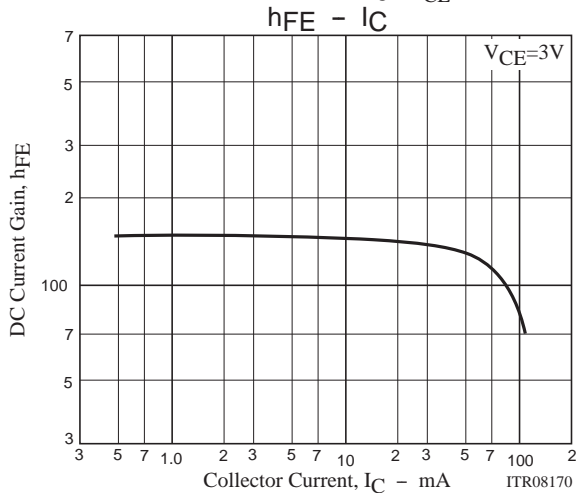
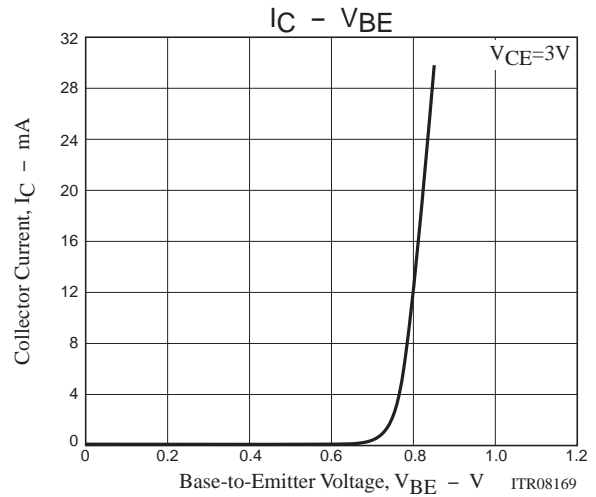
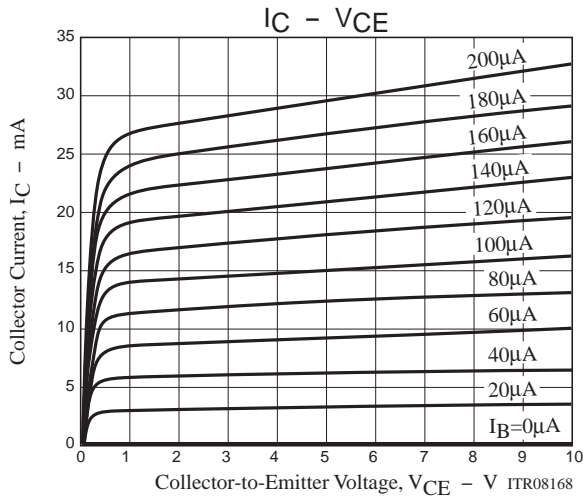

2SC5374A

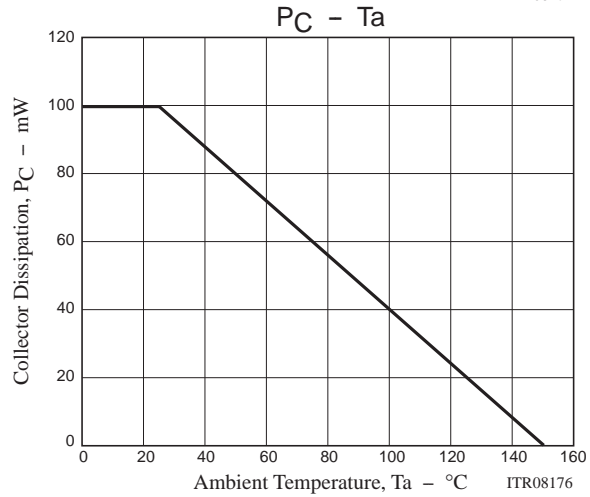
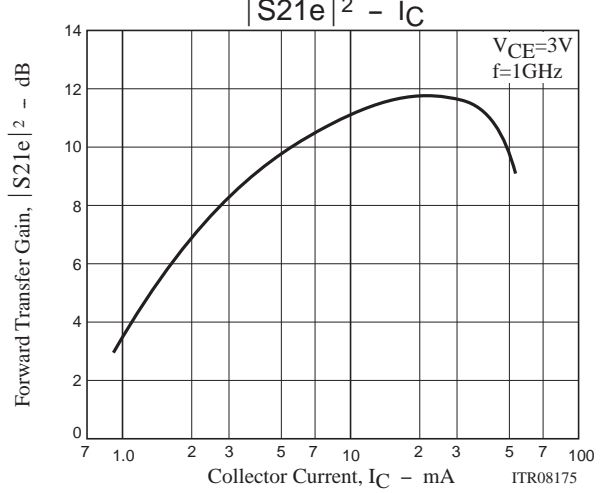
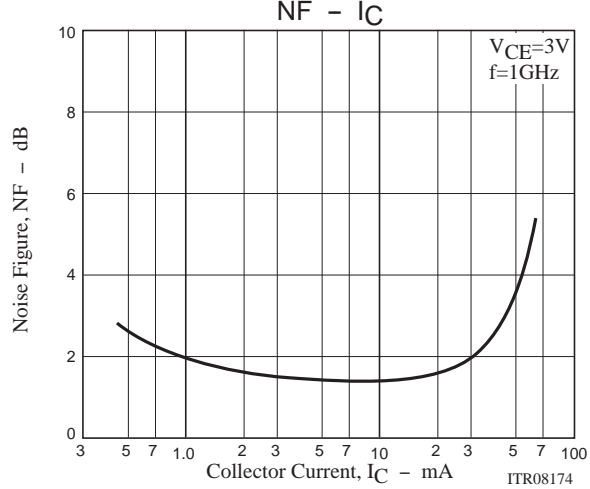
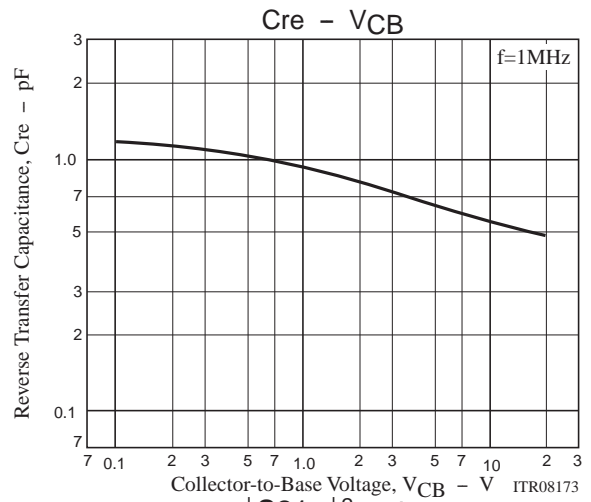
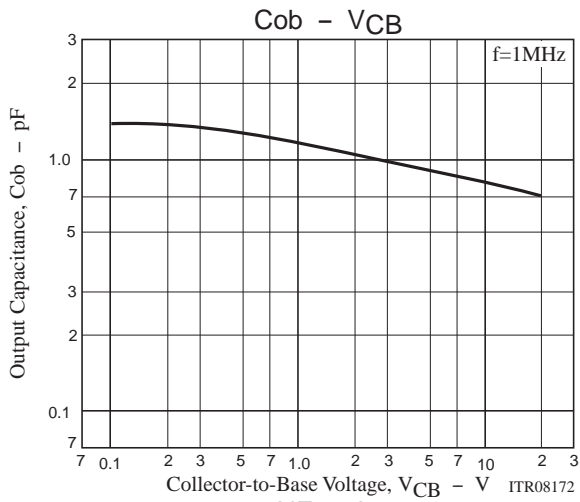

2SC5374A

S Parameter

S11e

f=100MHz, 200MHz to 2000MHz(200MHz Step)

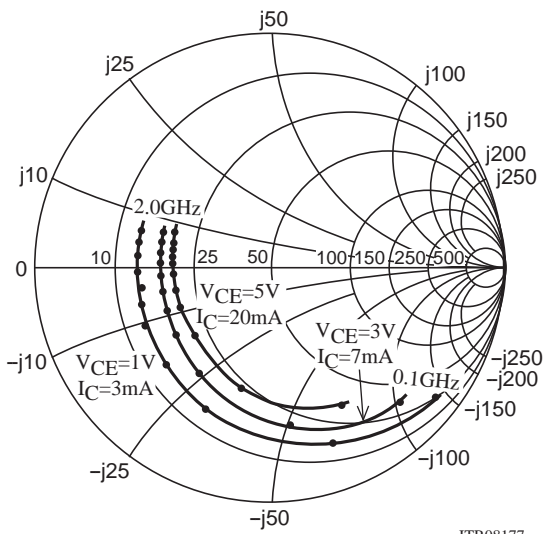

ITR08177

S21e

f=100MHz, 200MHz to 2000MHz(200MHz Step)

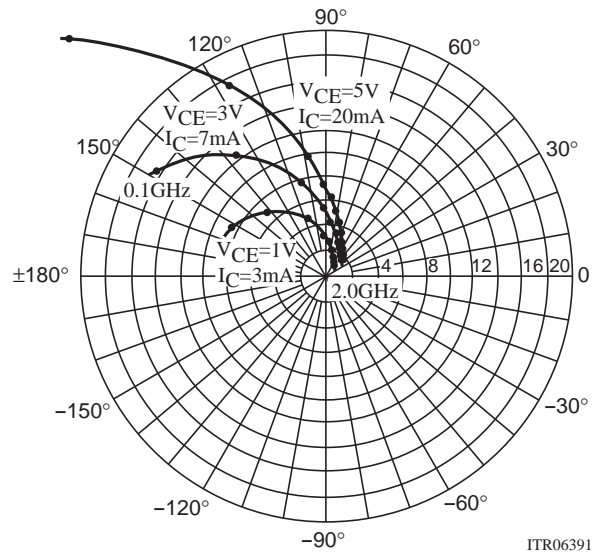

ITR06391

S12e

f=100MHz, 200MHz to 2000MHz(200MHz Step)

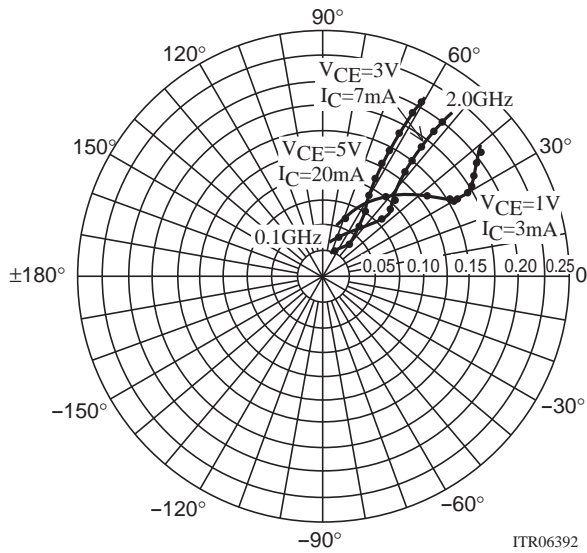

ITR06392

S22e

f=100MHz, 200MHz to 2000MHz(200MHz Step)

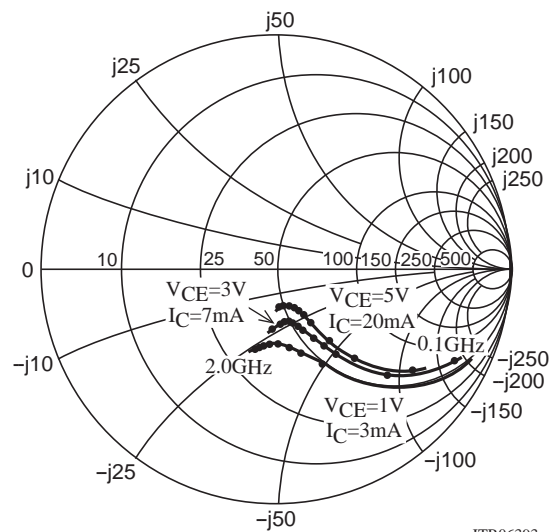

ITR06393

2SC5374A

S Parameters (Common emitter)

$V_{CE}=1V, I_C=3mA, Z_O=50\Omega$

Freq(MHz)	S11	$\angle S11$	S21	$\angle S21$	S12	$\angle S12$	S22	$\angle S22$
100	0.875	-40.6	8.627	152.3	0.062	67.9	0.918	-23.4
200	0.785	-71.6	6.874	132.5	0.101	52.1	0.748	-41.7
400	0.651	-114.8	4.701	107.3	0.135	37.1	0.537	-57.6
600	0.613	-136.9	3.365	92.8	0.152	31.1	0.430	-65.6
800	0.581	-153.9	2.716	81.9	0.155	29.9	0.361	-74.3
1000	0.568	-164.2	2.218	73.4	0.161	30.0	0.326	-80.2
1200	0.556	-172.0	1.863	66.2	0.170	30.5	0.300	-86.1
1400	0.563	-178.1	1.626	59.6	0.177	32.7	0.297	-92.3
1600	0.558	175.4	1.473	53.9	0.185	35.4	0.306	-96.5
1800	0.560	168.9	1.345	48.1	0.196	37.4	0.313	-100.6
2000	0.567	163.1	1.230	42.5	0.205	38.0	0.335	-102.9

$V_{CE}=3V, I_C=7mA, Z_O=50\Omega$

Freq(MHz)	S11	$\angle S11$	S21	$\angle S21$	S12	$\angle S12$	S22	$\angle S22$
100	0.789	-48.3	16.232	147.7	0.039	66.1	0.862	-27.2
200	0.670	-83.7	12.431	126.4	0.061	53.0	0.673	-44.6
400	0.552	-123.8	7.607	104.7	0.081	45.2	0.438	-59.1
600	0.522	-145.3	5.401	92.7	0.094	45.9	0.333	-65.1
800	0.504	-158.5	4.155	84.1	0.106	48.2	0.290	-68.7
1000	0.488	-169.1	3.425	77.1	0.121	49.1	0.270	-71.0
1200	0.478	-176.1	2.849	71.0	0.136	51.0	0.253	-74.7
1400	0.481	178.4	2.511	65.6	0.152	52.2	0.239	-79.6
1600	0.478	172.7	2.237	60.7	0.167	52.8	0.240	-82.8
1800	0.492	167.4	2.016	55.5	0.185	53.2	0.245	-86.7
2000	0.489	162.0	1.844	50.5	0.200	52.7	0.248	-90.0

$V_{CE}=5V, I_C=20mA, Z_O=50\Omega$

Freq(MHz)	S11	$\angle S11$	S21	$\angle S21$	S12	$\angle S12$	S22	$\angle S22$
100	0.643	-66.4	26.381	137.4	0.029	62.8	0.748	-36.3
200	0.530	-104.6	17.543	116.5	0.041	54.2	0.531	-52.5
400	0.459	-140.3	9.835	98.9	0.058	55.4	0.322	-62.7
600	0.447	-157.2	6.805	89.4	0.074	59.2	0.246	-65.5
800	0.440	-168.4	5.210	82.4	0.092	61.4	0.213	-68.6
1000	0.434	-175.9	4.194	76.6	0.110	61.9	0.199	-70.2
1200	0.437	177.1	3.518	71.5	0.129	62.3	0.191	-72.9
1400	0.437	173.0	3.077	66.7	0.148	61.8	0.184	-76.5
1600	0.438	168.4	2.730	62.5	0.166	61.6	0.181	-80.9
1800	0.439	164.2	2.459	58.0	0.186	60.7	0.186	-84.8
2000	0.444	159.1	2.249	53.5	0.203	59.5	0.192	-87.3

Embossed Taping Specification

2SC5374A-TL-E

1. Packing Format

Package Name	Carrier Tape Type	Maximum Number of devices contained (pcs)			Packing format	
		Reel	Inner box	Outer box	Inner BOX (C-1)	Outer BOX (A-7)
SMCP	SMCP	3,000	15,000	90,000	5 reels contained Dimensions:mm (external) 183×72×185	6 inner boxes contained Dimensions:mm (external) 440×195×210

Packing method

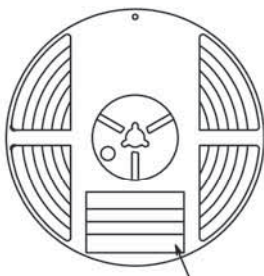

Reel label

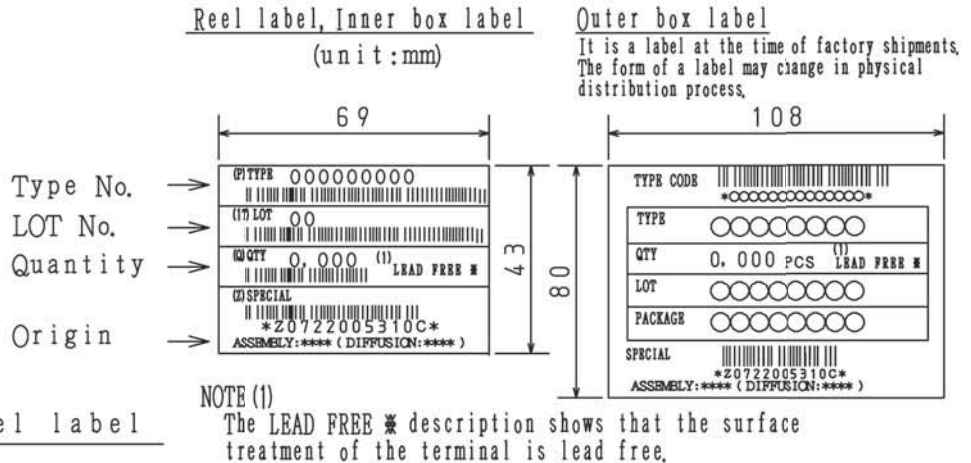

Label	JEITA Phase
.....	JEITA Phase 3

2. Taping configuration

2-1. Carrier tape size (unit:mm)

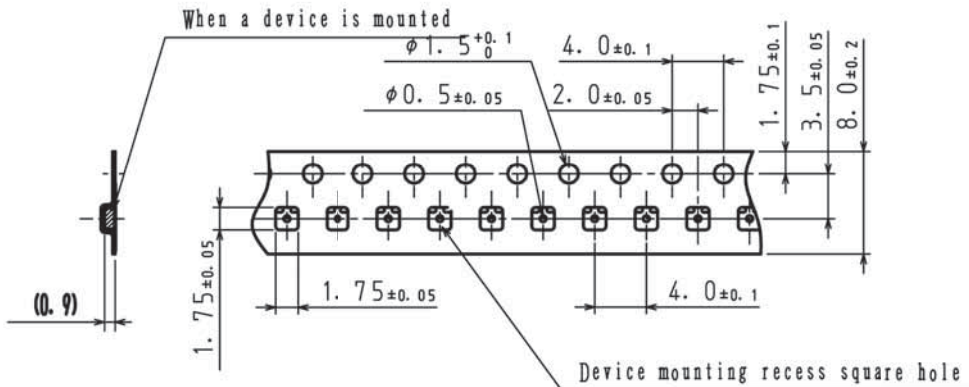

2-2. Device placement direction

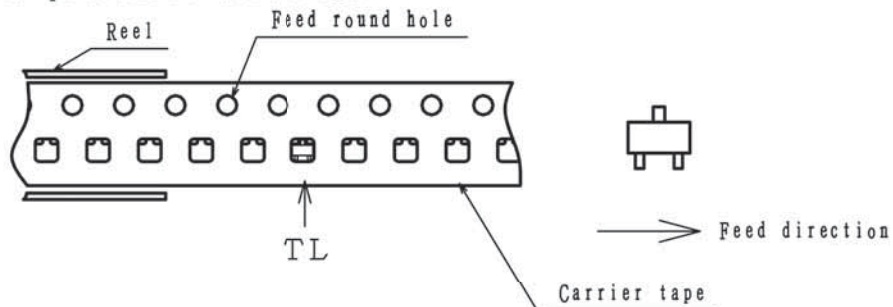

Those with one electrode terminal on the feed hole side.....TL

2SC5374A

Outline Drawing

2SC5374A-TL-E

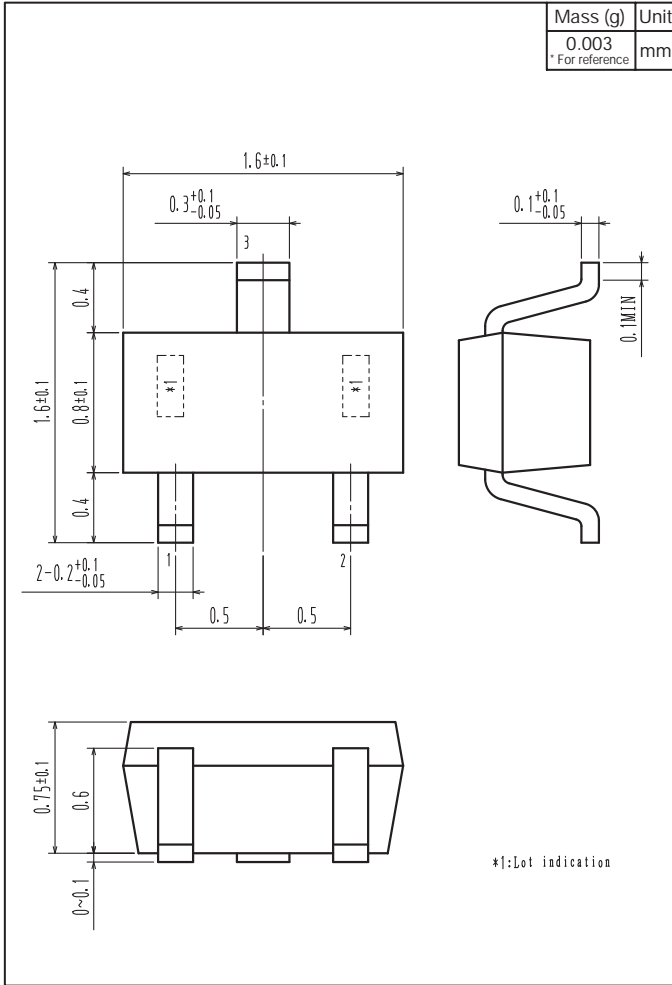

Land Pattern Example

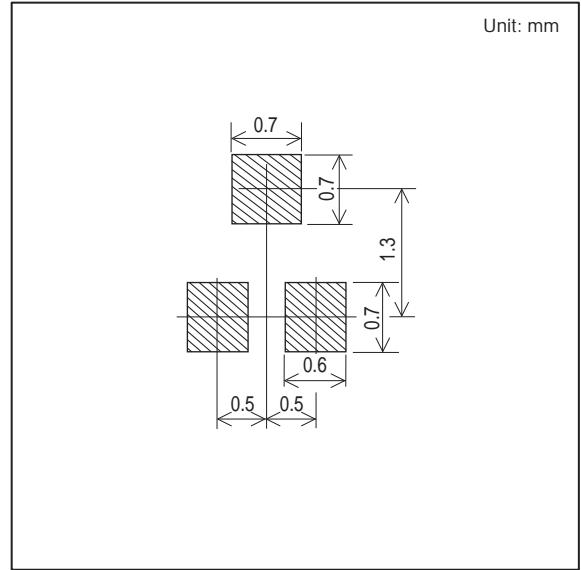

- Any and all SANYO Semiconductor Co.,Ltd. products described or contained herein are, with regard to "standard application", intended for the use as general electronics equipment. The products mentioned herein shall not be intended for use for any "special application" (medical equipment whose purpose is to sustain life, aerospace instrument, nuclear control device, burning appliances, transportation machine, traffic signal system, safety equipment etc.) that shall require extremely high level of reliability and can directly threaten human lives in case of failure or malfunction of the product or may cause harm to human bodies, nor shall they grant any guarantee thereof. If you should intend to use our products for new introduction or other application different from current conditions on the usage of automotive device, communication device, office equipment, industrial equipment etc. , please consult with us about usage condition (temperature, operation time etc.) prior to the intended use. If there is no consultation or inquiry before the intended use, our customer shall be solely responsible for the use.
- Specifications of any and all SANYO Semiconductor Co.,Ltd. products described or contained herein stipulate the performance, characteristics, and functions of the described products in the independent state, and are not guarantees of the performance, characteristics, and functions of the described products as mounted in the customer's products or equipment. To verify symptoms and states that cannot be evaluated in an independent device, the customer should always evaluate and test devices mounted in the customer's products or equipment.
- SANYO Semiconductor Co.,Ltd. assumes no responsibility for equipment failures that result from using products at values that exceed, even momentarily, rated values (such as maximum ratings, operating condition ranges, or other parameters) listed in products specifications of any and all SANYO Semiconductor Co.,Ltd. products described or contained herein.
- Regarding monolithic semiconductors, if you should intend to use this IC continuously under high temperature, high current, high voltage, or drastic temperature change, even if it is used within the range of absolute maximum ratings or operating conditions, there is a possibility of decrease reliability. Please contact us for a confirmation.
- SANYO Semiconductor Co.,Ltd. strives to supply high-quality high-reliability products, however, any and all semiconductor products fail or malfunction with some probability. It is possible that these probabilistic failures or malfunction could give rise to accidents or events that could endanger human lives, trouble that could give rise to smoke or fire, or accidents that could cause damage to other property. When designing equipment, adopt safety measures so that these kinds of accidents or events cannot occur. Such measures include but are not limited to protective circuits and error prevention circuits for safe design, redundant design, and structural design.
- In the event that any or all SANYO Semiconductor Co.,Ltd. products described or contained herein are controlled under any of applicable local export control laws and regulations, such products may require the export license from the authorities concerned in accordance with the above law.
- No part of this publication may be reproduced or transmitted in any form or by any means, electronic or mechanical, including photocopying and recording, or any information storage or retrieval system, or otherwise, without the prior written consent of SANYO Semiconductor Co.,Ltd.
- Any and all information described or contained herein are subject to change without notice due to product/technology improvement, etc. When designing equipment, refer to the "Delivery Specification" for the SANYO Semiconductor Co.,Ltd. product that you intend to use.
- Upon using the technical information or products described herein, neither warranty nor license shall be granted with regard to intellectual property rights or any other rights of SANYO Semiconductor Co.,Ltd. or any third party. SANYO Semiconductor Co.,Ltd. shall not be liable for any claim or suits with regard to a third party's intellectual property rights which has resulted from the use of the technical information and products mentioned above.

This catalog provides information as of August, 2012. Specifications and information herein are subject to change without notice.