

REV	ECN NO	REVISIONS	DRN	CKD	APP	DATE
A		NEW RELEASE	TWC			
B		MAX INTENSITY FOR GREEN WAS "280"; MAX INTENSITY FOR BLUE WAS "112"; DC FORWARD CURRENT FOR GREEN WAS "30"	AJF	KLJ	NO	3-8-11

DIALIGHT CATALOG P/N	COLOR	DOMINANT WAVELENGTH $I_f = 20\text{mA}$	PEAK EMISSION WAVELENGTH $I_f = 20\text{mA}$ λ_{PK} (nm)	SPECTRAL LINE HALF WIDTH $\Delta\lambda$ (nm) $I_f = 20\text{mA}$ TYP	LUMINOUS INTENSITY (mcd) @ $I_f = 20\text{mA}$; 25°C		FORWARD VOLTAGE (V) @ $I_f = 20\text{mA}$; 25°C		REVERSE CURRENT (μA); 25°C	VIEWING ANGLE (2° @ 1/2 (DEG.))
					MIN.	MAX.	TYP.	MAX.	MAX.	TYP
597-2712-602F	All InGaP RED	624	632	20	45.0	180.0	2.0	2.4	10 @ $V_R = 5\text{V}$	130
597-2712-607F	InGaN GREEN	525	520	35	112.0	450.0	3.5	3.8	10 @ $V_R = 5\text{V}$	130
	InGaN BLUE	470	468	26	28.0	180.0	3.5	3.8	10 @ $V_R = 5\text{V}$	130

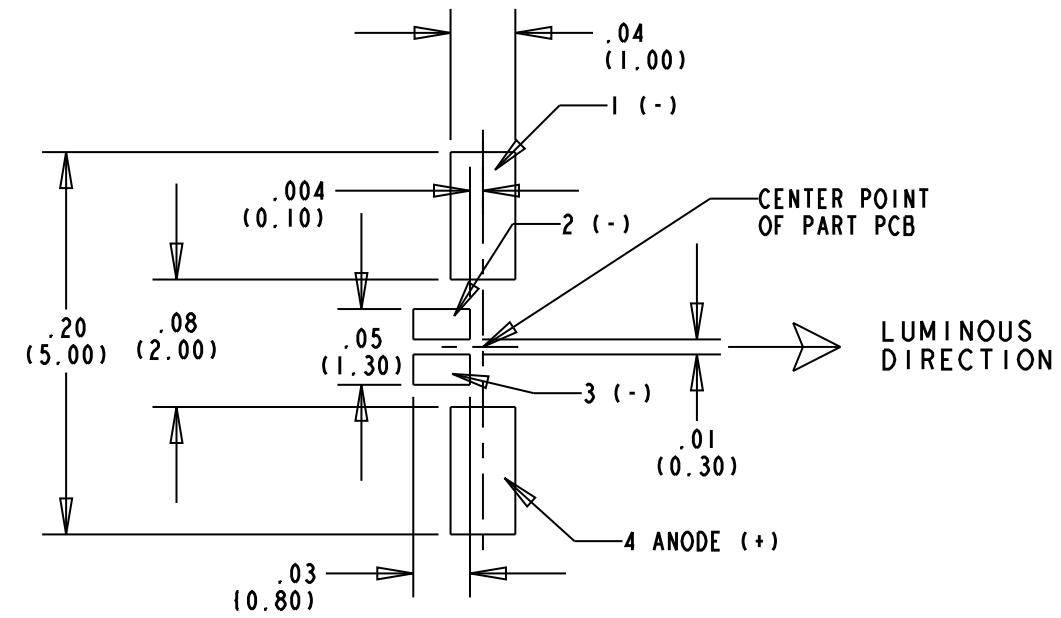

RECOMMENDED SOLDERING PAD

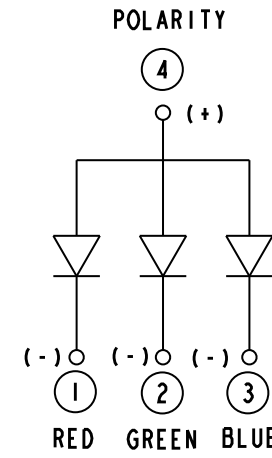
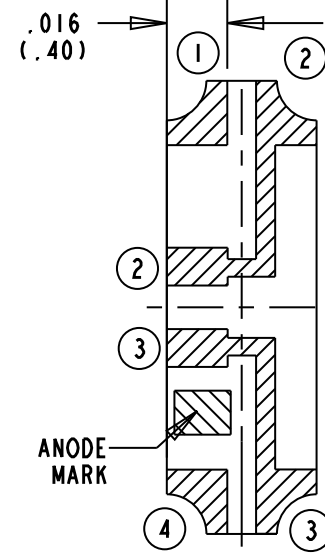
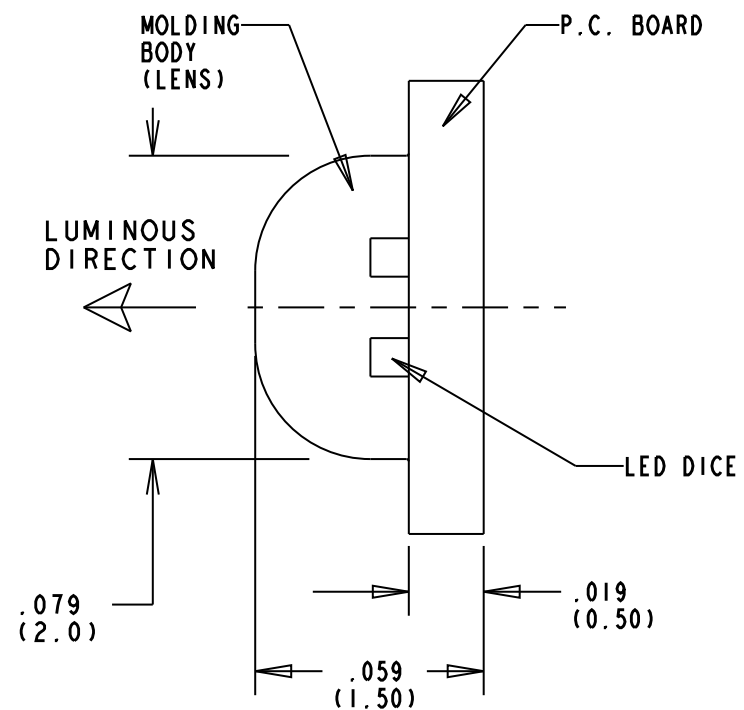
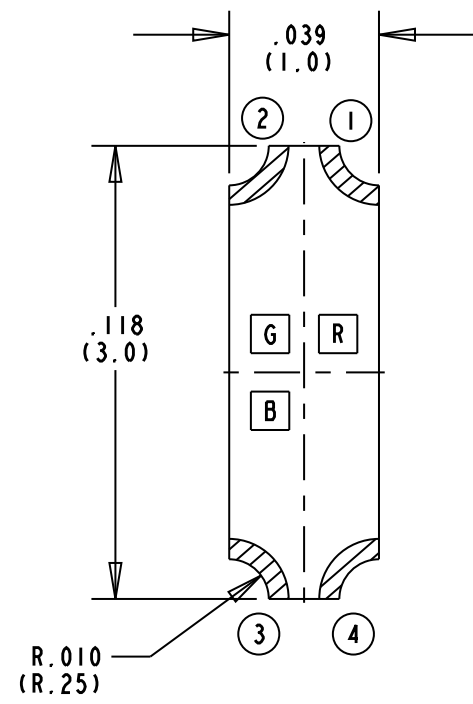
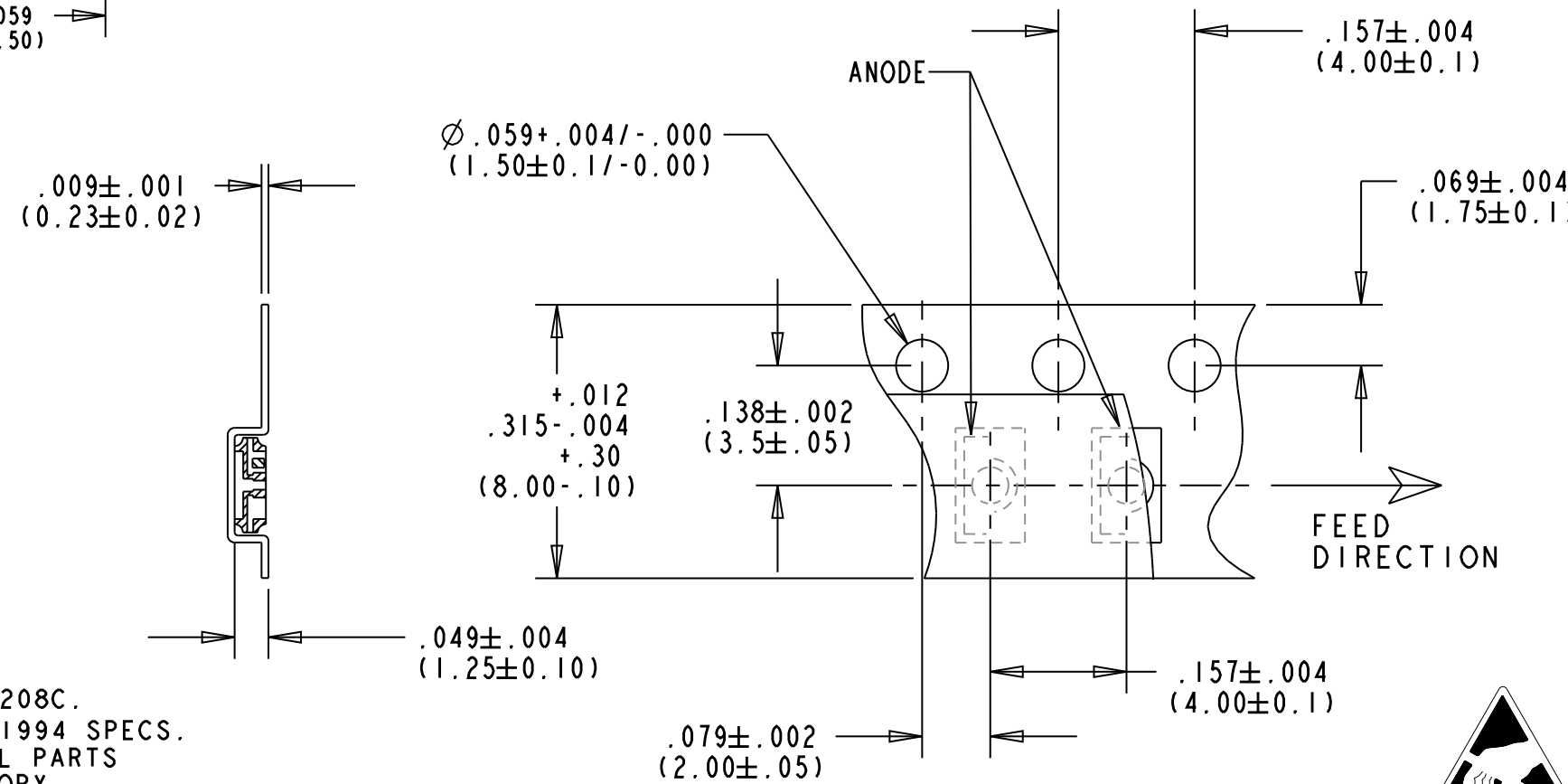

TAPING SPECIFICATION
NO SCALE

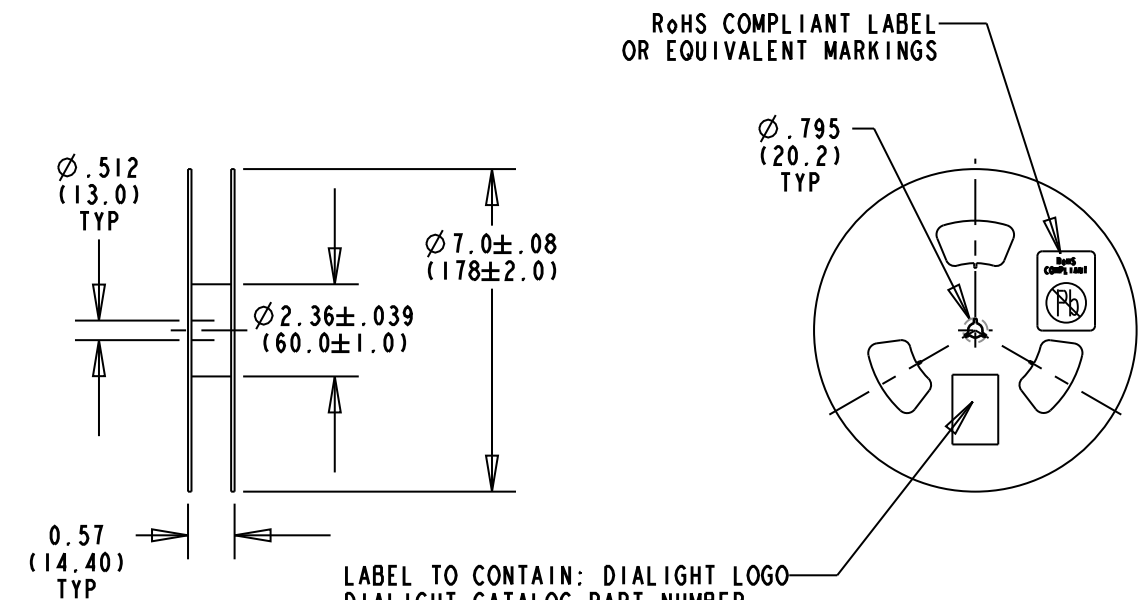

LABEL TO CONTAIN: DIALIGHT LOGO
DIALIGHT CATALOG PART NUMBER,
QUANTITY, DATE OF MANUFACTURE,
LOT NUMBER, RANK OF LUMINOUS
INTENSITY, COUNTRY OF ORIGIN.

ATTENTION:
OBSERVE PRECAUTIONS FOR
HANDLING ELECTROSTATIC
SENSITIVE DEVICES

(QUANTITY: 3,000 PCS/REEL)
REEL SPECIFICATION
NO SCALE

- NOTES:
1. All InGaP FOR RED, InGaN GREEN, InGaN BLUE
 2. EPOXY COLOR: WHITE DIFFUSED
 3. SOLDER PAD: COPPER BASE, GOLD PLATED.
 4. SOLDER ADHERANCE PER MIL. STD. 202E, METHOD 208C.
 5. PARTS TAPED AND REELED PER ANSI/EIA 481-1-A-1994 SPECS.
 6. PARTS SUPPLIED 3,000 PIECES PER REEL WITH ALL PARTS ON ONE REEL FROM SAME LOT AND SAME BIN CATEGORY.
 7. REEL PACKED IN ANTI-HUMIDITY ALUMINIUM FOIL BAG, HEAT SEALED WITH SILICA GEL. LABEL ON BAG TO CONTAIN SAME INFORMATION AS LABEL ON REEL.
 8. DEVICE HAS A MOISTURE SENSITIVITY LEVEL "4" CAUTION LABEL APPLIED AS PER JEDEC STD. .033.
 9. STORAGE CONDITION: 5 TO 30°C @ 70% RH MAX. BAKING IS REQUIRED IF THE PACK HAS BEEN OPENED FOR 72 HOURS OR MORE. BAKING RECOMMENDED CONDITION: 60±5°C FOR 24 HOURS.
 10. TAPE AND REEL LED'S MAY REQUIRE RE-TAPING AFTER TWELVE MONTHS.
 11. DIALIGHT PART NUMBER: 597-2712-602F, AND -607F
 12. THIS ASSEMBLY CONTAINS ELECTROSTATIC DISCHARGE SENSITIVE DEVICES (ESDS). MAINTAIN ALL PRECAUTIONARY MEASURES DURING ASSEMBLY, HANDLING AND STORAGE IN ACCORDANCE WITH IPC-A-610.

ABSOLUTE MAXIMUM RATINGS AT 25°C.	RED	GREEN	BLUE	UNITS
POWER DISSIPATION	75	80	80	mW
PEAK FORWARD CURRENT (1/10 DUTY CYCLE, 0.1ms PULSE WIDTH)	80	100	100	mA
DC FORWARD CURRENT	30	20	20	mA
DERATING LINEAR FROM 25°C	0.4	0.25	0.25	mA/°C
REVERSE VOLTAGE	5	5	5	V
OPERATING TEMPERATURE RANGE	-20 TO +80			°C
STORAGE TEMPERATURE	-30 TO +100			°C
INFRARED SOLDERING CONDITION	260°C FOR 5 SECONDS			

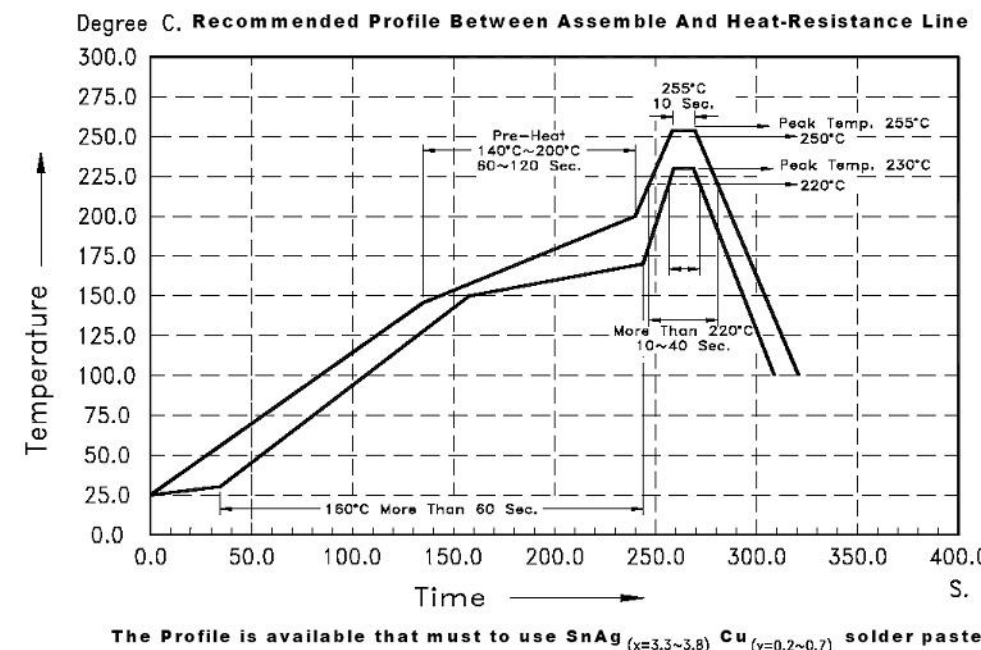

The Profile is available that must to use SnAg (x=3.3-3.8) Cu (y=0.2-0.7) solder paste

RoHS Compliant 597-2712-60XF Surface Mount LED
Part Numbers with the "F" suffix ending are RoHS Compliant.
Example: 597-2712-607F
Packaging is marked with "RoHS Compliant" label or equivalent markings.
Parts can be reflow soldered per RoHS reflow profile, wave soldered, dip soldered or hand soldered using typical lead-free soldering process with max 260°C temp. for 5 sec.

THIS DRAWING AND THE CONTENTS HEREIN ARE CONFIDENTIAL AND THE SOLE PROPERTY OF DIALIGHT. REPRODUCTION OF THIS DRAWING OR CONSTRUCTION OF ANY PARTS WITHIN THIS DRAWING ARE FORBIDDEN WITHOUT THE WRITTEN CONSENT OF DIALIGHT.		
SCALE: 20:1	DRAWING NUMBER	REV
ALL DIM'S IN: INCHES (MM)	C-17214	B
TOLERANCES: UNLESS OTHERWISE SPECIFIED	TITLE R,G,B RIGHT ANGLE SURFACE MOUNT LED, RoHS COMPLIANT	
FRACTIONS: ±1/64	MATERIAL	
DECIMALS (.XX): ±.01	Dialight	
DECIMALS (.XXX): ±.005	1501 ROUTE 34 SOUTH FARMINGDALE, NJ 07727	
DECIMALS (.XXXX): ±.0005	FINISH:	
ANGLES: ±1°	FSCM 83330	
	SHEET 1 OF 1	FAMILY TABLES: