



## 8050S

## NPN SILICON TRANSISTOR

LOW VOLTAGE HIGH  
CURRENT SMALL SIGNAL  
NPN TRANSISTOR

### DESCRIPTION

The UTC **8050S** is a low voltage high current small signal NPN transistor, designed for Class B push-pull audio amplifier and general purpose applications.

### FEATURES

- \*Collector current up to 700mA
- \*Collector-Emitter voltage up to 20V
- \*Complementary to UTC 8550S

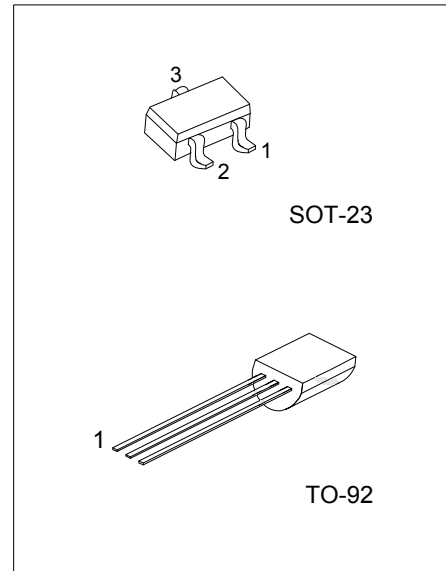

### ORDERING INFORMATION

Ordering Number			Package	Pin Assignment			Packing
Normal	Lead Free Plating	Halogen-Free		1	2	3	
8050S-x-AE3-R	8050SL-x-AE3-R	8050SG-x-AE3-R	SOT-23	E	B	C	Tape Reel
8050S-x-T92-B	8050SL-x-T92-B	8050SG-x-T92-B	TO-92	E	C	B	Tape Box
8050S-x-T92-K	8050SL-x-T92-K	8050SG-x-T92-K	TO-92	E	C	B	Bulk

<p>8050SL-x-AE3-R</p>	<p>(1) B: Tape Box, K: Bulk, R: Tape Reel</p> <p>(2) AE3: SOT-23, T92: TO-92</p> <p>(3) x: refer to Classification of <math>h_{FE2}</math></p> <p>(4) G: Halogen Free, L: Lead Free, Blank: Pb/Sn</p>
-----------------------	---

### MARKING (For SOT-23 Package)

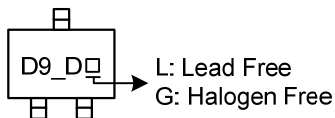

■ ABSOLUTE MAXIMUM RATING ( Ta=25°C, unless otherwise specified )

PARAMETER		SYMBOL	RATINGS	UNIT
Collector-Base Voltage		$V_{CBO}$	30	V
Collector-Emitter Voltage		$V_{CEO}$	20	V
Emitter-Base Voltage		$V_{EBO}$	5	V
Collector Current		$I_C$	700	mA
Collector Dissipation(Ta=25°C)	SOT-23	$P_C$	350	mW
	TO-92		1	W
Junction Temperature		$T_J$	+150	°C
Storage Temperature		$T_{STG}$	-40 ~ +150	°C

Note: Absolute maximum ratings are those values beyond which the device could be permanently damaged. Absolute maximum ratings are stress ratings only and functional device operation is not implied.

■ ELECTRICAL CHARACTERISTICS (Ta=25°C, unless otherwise specified)

PARAMETER	SYMBOL	TEST CONDITIONS	MIN	TYP	MAX	UNIT
Collector-Base Breakdown Voltage	$BV_{CBO}$	$I_C = 100\mu A, I_E = 0$	30			V
Collector-Emitter Breakdown Voltage	$BV_{CEO}$	$I_C = 1mA, I_B = 0$	20			V
Emitter-Base Breakdown Voltage	$BV_{EBO}$	$I_E = 100\mu A, I_C = 0$	5			V
Collector Cut-Off Current	$I_{CBO}$	$V_{CB} = 30V, I_E = 0$			1	$\mu A$
Emitter Cut-Off Current	$I_{EBO}$	$V_{EB} = 5V, I_C = 0$			100	nA
DC Current Gain(note)	$h_{FE1}$	$V_{CE} = 1V, I_C = 1mA$	100		400	
	$h_{FE2}$	$V_{CE} = 1V, I_C = 150mA$	120			
	$h_{FE3}$	$V_{CE} = 1V, I_C = 500mA$	40			
Collector-Emitter Saturation Voltage	$V_{CEO(SAT)}$	$I_C = 500mA, I_B = 50mA$			0.5	V
Base-Emitter Saturation Voltage	$V_{BEO(SAT)}$	$I_C = 500mA, I_B = 50mA$			1.2	V
Base-Emitter Saturation Voltage	$V_{BEO(SAT)}$	$V_{CE} = 1V, I_C = 10mA$			1.0	V
Current Gain Bandwidth Product	$f_T$	$V_{CE} = 10V, I_C = 50mA$	100			MHz
Output Capacitance	Cob	$V_{CB} = 10V, I_E = 0, f = 1MHz$		9.0		pF

■ CLASSIFICATION OF  $h_{FE2}$

RANK	C	D	E
RANGE	120-200	160-300	280-400

■ TYPICAL CHARACTERISTICS

Static Characteristics

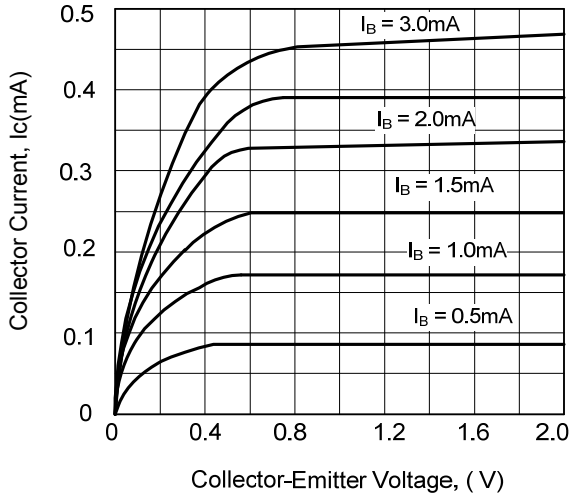

DC Current Gain

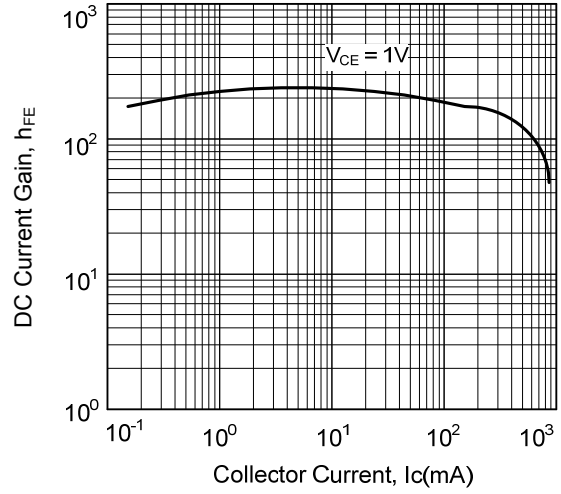

Base-Emitter on Voltage

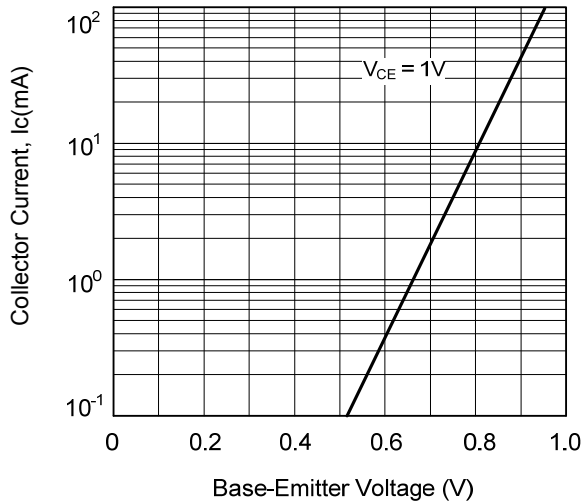

Saturation Voltage

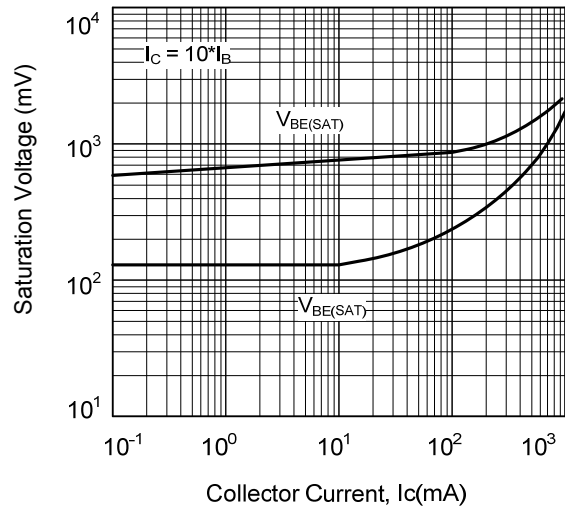

Current Gain-Bandwidth Product

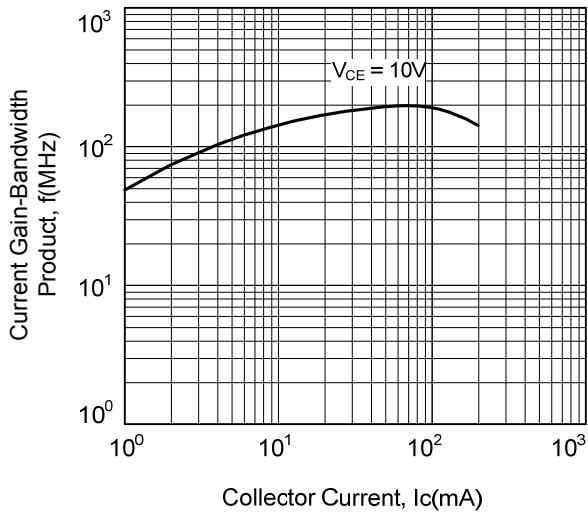

Collector Output Capacitance

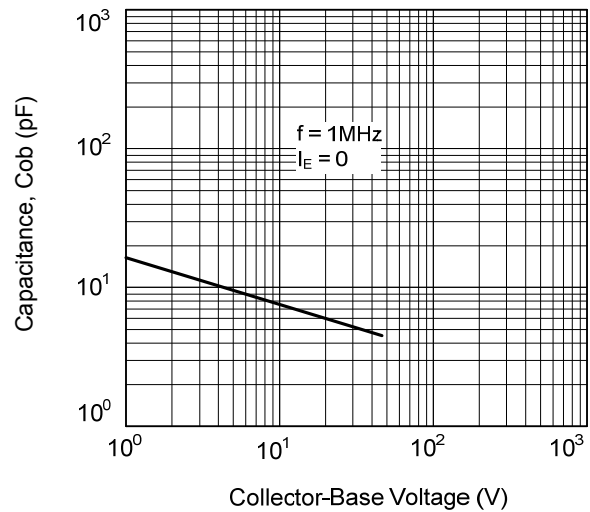

UTC assumes no responsibility for equipment failures that result from using products at values that exceed, even momentarily, rated values (such as maximum ratings, operating condition ranges, or other parameters) listed in products specifications of any and all UTC products described or contained herein. UTC products are not designed for use in life support appliances, devices or systems where malfunction of these products can be reasonably expected to result in personal injury. Reproduction in whole or in part is prohibited without the prior written consent of the copyright owner. The information presented in this document does not form part of any quotation or contract, is believed to be accurate and reliable and may be changed without notice.