

FEATURES

5Ω Max On Resistance
0.5Ω Max On Resistance Flatness
33 V Supply Maximum Ratings
Fully specified at ±15V/12V/±5V
3V Logic Compatible Inputs
Rail-to-Rail Operation
Break-Before-Make Switching Action
16-Lead TSSOP Packages
Typical Power Consumption (< 0.03 μW)

APPLICATIONS

Relay Replacement
Audio and Video Routing
Automatic Test Equipment
Data Acquisition Systems
Battery-Powered Systems
Sample-and-Hold Systems
Communication Systems

GENERAL DESCRIPTION

The ADG1408 and ADG1409 are monolithic CMOS analog multiplexers comprising eight single channels and four differential channels, respectively. The ADG1408 switches one of eight inputs to a common output as determined by the 3-bit binary address lines A0, A1, and A2. The ADG1409 switches one of four differential inputs to a common differential output as determined by the 2-bit binary address lines A0 and A1. An EN input on both devices is used to enable or disable the device. When disabled, all channels are switched OFF.

The ADG1408/ADG1409 are designed on an enhanced CMOS process that provides low power dissipation yet gives high switching speed and low on resistance. Each channel conducts equally well in both directions when ON and has an input signal range that extends to the supplies. In the OFF condition, signal levels up to the supplies are blocked. All channels exhibit break-before-make switching action, preventing momentary shorting when switching channels. Inherent in the design is low charge injection for minimum transients when switching the digital inputs.

RevPrA

Information furnished by Analog Devices is believed to be accurate and reliable. However, no responsibility is assumed by Analog Devices for its use, nor for any infringements of patents or other rights of third parties that may result from its use. Specifications subject to change without notice. No license is granted by implication or otherwise under any patent or patent rights of Analog Devices. Trademarks and registered trademarks are the property of their respective companies.

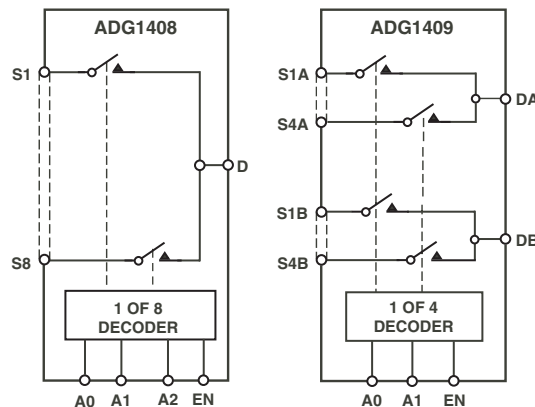
FUNCTIONAL BLOCK DIAGRAMS

SWITCHES SHOWN FOR A "1" LOGIC INPUT

PRODUCT HIGHLIGHTS

1. 5Ω Max On Resistance
2. 0.5Ω Max On Resistance Flatness
3. 3V Logic Compatible Digital Input
 $V_{IH} = 2.0V$, $V_{IL} = 0.8V$
4. 16 Lead TSSOP package

TABLE OF CONTENTS

ADG1408/ADG1409—Specifications	3	Terminology	9
Dual Supply	3	Typical Performance Characteristics	10
Single Supply	4	Test Circuits.....	12
Absolute Maximum Ratings.....	7	Outline Dimensions	15
ESD Caution.....	7	Ordering Guide.....	16
Pin Configurations (TSSOP)	8		

REVISION HISTORY

ADG1408/ADG1409—SPECIFICATIONS

DUAL SUPPLY¹Table 1. $V_{DD} = +15\text{ V} \pm 10\%$, $V_{SS} = -15\text{ V} \pm 10\%$, $GND = 0\text{ V}$, unless otherwise noted.

Parameter	-40°C to		-40°C to +125°C	Unit	Test Conditions/Comments
	+25°C	+85°C			
ANALOG SWITCH					
Analog Signal Range			V_{SS} to V_{DD}	V	
R_{ON}	3			Ω typ	$V_D = \pm 10\text{ V}$, $I_S = -10\text{ mA}$
	4	5	5	Ω max	
R_{ON} Flatness				Ω typ	$V_D = +10\text{ V}$, -10 V
	0.5			Ω max	
ΔR_{ON}	0.5			Ω typ	$V_D = +10\text{ V}$, -10 V
				Ω max	
LEAKAGE CURRENTS					
Source OFF Leakage I_S (OFF)	± 0.01			nA typ	$V_D = \pm 10\text{ V}$, $V_S = -10\text{ V}$; Test Circuit 2
	± 0.5	± 2.5	± 50	nA max	± 0.5
Drain OFF Leakage I_D (OFF)					$V_D = \pm 10\text{ V}$; $V_S = \pm 10\text{ V}$;
ADG1408	± 1	± 100	± 100	nA max	Test Circuit 3
ADG1409	± 1	± 50	± 50	nA max	
Channel ON Leakage I_D , I_S (ON)					$V_S = V_D = \pm 10\text{ V}$;
ADG1408	± 1	± 100	± 100	nA max	Test Circuit 4
ADG1409	± 1	± 50	± 50	nA max	
DIGITAL INPUTS					
Input High Voltage, V_{INH}		2.0	2.0	V min	
Input Low Voltage, V_{INL}		0.8	0.8	V max	
Input Current					
I_{INL} or I_{INH}	± 0.005			μA max	$V_{IN} = V_{INL}$ or V_{INH}
		± 0.5	± 0.5	μA max	
C_{IN} , Digital Input Capacitance	5			pF typ	
DYNAMIC CHARACTERISTICS ²					
$t_{TRANSITION}$	80	120	120	ns typ	$R_L = 300\ \Omega$, $C_L = 35\text{ pF}$;
		250	250	ns max	$V_{S1} = \pm 10\text{ V}$, $V_{S8} = \pm 10\text{ V}$;
T_{BBM}	10	10	10	ns typ	Test Circuit 5
			1	ns min	$R_L = 300\ \Omega$, $C_L = 35\text{ pF}$;
$t_{ON}(EN)$	85	125	125	ns typ	$V_S = 10\text{ V}$; Test Circuit 6
	150	225	225	ns max	$R_L = 300\ \Omega$, $C_L = 35\text{ pF}$;
$t_{OFF}(EN)$	40	65	65	ns typ	$V_S = 5\text{ V}$; Test Circuit 7
		150	150	ns max	$R_L = 300\ \Omega$, $C_L = 35\text{ pF}$;
Charge Injection	20		20	pC typ	$V_S = 0\text{ V}$, $R_S = 0\ \Omega$, $C_L = 10\text{ nF}$; Test Circuit 8
OFF Isolation	75			dB typ	$R_L = 1\text{ k}\Omega$, $f = 100\text{ kHz}$;
Channel-to-Channel Crosstalk	85			dB typ	$V_{EN} = 0\text{ V}$; Test Circuit 9
					$R_L = 1\text{ k}\Omega$, $f = 100\text{ kHz}$;
Total Harmonic Distortion, THD + N	0.002			% typ	Test Circuit 10
					$R_L = 600\ \Omega$, $5V_{rms}$; $f = 20\text{ Hz}$ to 20 kHz
-3dB Bandwidth	50			MHz typ	$R_L = 300\ \Omega$, $C_L = 5\text{ pF}$; Test Circuit 10
					Test Circuit 10
C_S (OFF)	15			pF typ	$f = 1\text{ MHz}$
C_D (OFF)					$f = 1\text{ MHz}$

Parameter	-40°C to		Unit	Test Conditions/Comments
	+25°C	+85°C		
ADG1408	100		pF typ	f = 1 MHz
ADG1409	50		pF typ	
C _D , C _S (ON)				
ADG1408	150		pF typ	
ADG1409	75		pF typ	
POWER REQUIREMENTS				
I _{DD}	0.001		μA typ	V _{DD} = +16.5V, V _{SS} = -16.5V Digital Inputs= 0 V or V _{DD}
		5	μA max	
I _{DD}	150		μA typ	Digital Inputs= 5 V
			μA max	
I _{SS}	0.001		μA typ	Digital Inputs= 0 V or V _{DD}
		5	μA max	
I _{GND}	0.001		μA typ	Digital Inputs= 0 V or V _{DD}
		5	μA max	
I _{GND}	150		μA typ	Digital Inputs= 5 V
		5	μA max	
			μA max	

¹ Temperature ranges are as follows: B Version: -40°C to +85°C; T Version: -40°C to +125°C.

² Guaranteed by design, not subject to production test.

SINGLE SUPPLY¹

Table 2. V_{DD} = 12 V V ± 10%, V_{SS} = 0 V, GND = 0 V, unless otherwise noted.

Parameter	+25°C	-40°C to +85°C	-40°C to +125°C	Unit	Test Conditions/Comments
ANALOG SWITCH					
Analog Signal Range			0 to V _{DD}	V	
R _{ON}	6			Ω typ	V _D = 3 V, 10 V, I _S = -1 mA
	7	8	9	Ω max	
R _{ON} Flatness				Ω typ	V _D = 3 V, 10 V, I _S = -1 mA
	1.5			Ω max	
ΔR _{ON}	0.5			Ω typ	V _D = 3 V, 10 V, I _S = -1 mA
				Ω max	
Channel ON Leakage I _D , I _S (ON)					V _S = V _D = 8 V/0 V; Test Circuit 4
ADG1408	±1	±100	±100	nA max	
ADG1409	±1	±50	±50	nA max	
DIGITAL INPUTS					
Input High Voltage, V _{INH}		2.0	2.0	V min	
Input Low Voltage, V _{INL}		0.8	0.8	V max	
Input Current					
I _{INL} or I _{INH}		±10	±10	μA max	V _{IN} = 0 or V _{DD}
C _{IN} , Digital Input Capacitance	8			pF typ	f = 1 MHz
DYNAMIC CHARACTERISTICS²					
t _{TRANSITION}	130			ns typ	R _L = 300 Ω, C _L = 35 pF; V _{S1} = 8 V/0 V, V _{S8} = 0 V/8 V; Test Circuit 5
T _{BBM}	10			ns typ	R _L = 300 Ω, C _L = 35 pF; V _S = 5 V; Test Circuit 6
t _{ON} (EN)	140		1	ns min	R _L = 300 Ω C _L = 35 pF; V _S = 5 V; Test Circuit 7
t _{OFF} (EN)	60			ns typ	R _L = 300 Ω, C _L = 35 pF; V _S = 5 V; Test Circuit 7
Charge Injection	5			pC typ	V _S = 0 V, R _S = 0Ω, C _L = 10 nF;

Parameter	+25°C	-40°C to +85°C	-40°C to +125°C	Unit	Test Conditions/Comments
OFF Isolation	-75			dB typ	Test Circuit 8 R _L = 1 kΩ, f = 100 kHz;
Channel-to-Channel Crosstalk	85			dB typ	V _{EN} = 0 V; Test Circuit 9 R _L = 1 kΩ, f = 100 kHz;
Total Harmonic Distortion, THD + N	0.002			% typ	Test Circuit 10 R _L = 600 Ω, 5Vrms; f=20Hz to 20kHz
-3dB Bandwidth	50			MHz typ	R _L = 300 Ω, C _L = 5 pF; Test Circuit 10
C _S (OFF)	15			pF typ	f = 1 MHz
C _D (OFF)					f = 1 MHz
ADG1408	100			pF typ	
ADG1409	50			pF typ	
C _D , C _S (ON)					f = 1 MHz
ADG1408	150			pF typ	
ADG1409	75			pF typ	
POWER REQUIREMENTS					V _{DD} = 13.2V
I _{DD}		1	1	μA typ	Digital Inputs= 0 V or V _{DD}
		5	5	μA max	
I _{DD}	150			μA typ	Digital Inputs= 5
			300	μA max	

¹ Temperature ranges are as follows: B Version: -40°C to +85°; T Version: -55°C to +125°.

² Guaranteed by design, not subject to production test.

DUAL SUPPLY¹

Table 3. V_{DD} = +5 V ± 10%, V_{SS} = -5 V ± 10%, GND = 0 V, unless otherwise noted.

Parameter	+25°C	-40°C to +85°C	-40°C to +125°C	Unit	Test Conditions/Comments
ANALOG SWITCH					
Analog Signal Range			V _{SS} to V _{DD}	V	
R _{ON}	6			Ω typ	V _D = ±3.3 V, I _S = -10 mA
	7	8	10	Ω max	
ΔR _{ON}	0.5			Ω max	V _D = +3.3 V, -3.3 V
LEAKAGE CURRENTS					
Source OFF Leakage I _S (OFF)	±0.01			nA typ	V _D = ±3.3 V, V _S = -3.3 V; Test Circuit 2
	±0.5	±2.5	±50	nA max	
Drain OFF Leakage I _D (OFF)					V _D = ±3.3 V; V _S = ±3.3 V;
ADG1408	±1	±100	±100	nA max	Test Circuit 3
ADG1409	±1	±50	±50	nA max	
Channel ON Leakage I _D , I _S (ON)					V _S = V _D = ±3.3 V;
ADG1408	±1	±100	±100	nA max	Test Circuit 4
ADG1409	±1	±50	±50	nA max	
DIGITAL INPUTS					
Input High Voltage, V _{INH}		2.0	2.0	V min	
Input Low Voltage, V _{INL}		0.8	0.8	V max	
Input Current					
I _{INL} or I _{INH}	±0.005			μA max	V _{IN} = V _{INL} or V _{INH}
		±0.5	±0.5	μA max	
C _{IN} , Digital Input Capacitance	5			pF typ	
DYNAMIC CHARACTERISTICS²					
t _{TRANSITION}		120	120	ns typ	R _L = 300 Ω, C _L = 35 pF;

Parameter	+25°C	-40°C to +85°C	-40°C to +125°C	Unit	Test Conditions/Comments
T _{BBM}		250	250	ns max	V _{S1} = ±10 V, V _{S8} = ±10 V; Test Circuit 5
				ns typ	R _L = 300 Ω, C _L = 35 pF;
			1	ns min	V _S = 5 V; Test Circuit 6
t _{ON} (EN)	85	125	125	ns typ	R _L = 300 Ω, C _L = 35 pF;
	150	225	225	ns max	V _S = 5 V; Test Circuit 7
t _{OFF} (EN)		65	65	ns typ	R _L = 300 Ω, C _L = 35 pF;
		150	150	ns max	V _S = 5 V; Test Circuit 7
					V _S = 0 V, R _S = 0 Ω, C _L = 10 nF; Test Circuit 8
Charge Injection	20			pC typ	
OFF Isolation	-75		-75	dB typ	R _L = 1 kΩ, f = 100 kHz; V _{EN} = 0 V; Test Circuit 9
Channel-to-Channel Crosstalk	85		85	dB typ	R _L = 1 kΩ, f = 100 kHz; Test Circuit 10
Total Harmonic Distortion, THD + N	0.002			% typ	R _L = 600 Ω, 5Vrms; f=20Hz to 20kHz
-3dB Bandwidth	50			MHz typ	R _L = 300 Ω, C _L = 5 pF; Test Circuit 10
C _S (OFF)	15			pF typ	f = 1 MHz
C _D (OFF)					f = 1 MHz
ADG1408	100			pF typ	
ADG1409	50			pF typ	
C _D , C _S (ON)					f = 1 MHz
ADG1408	150			pF typ	
ADG1409	75			pF typ	
POWER REQUIREMENTS					V _{DD} = +16.5V, V _{SS} = -16.5V
I _{DD}	0.001			μA typ	Digital Inputs= 0 V or V _{DD}
		5	5	μA max	
I _{DD}	150			μA typ	Digital Inputs= 5 V
			300	μA max	
I _{SS}	0.001			μA typ	Digital Inputs= 0 V or V _{DD}
		5	5	μA max	
I _{GND}	0.001			μA typ	Digital Inputs= 0 V or V _{DD}
		5	5	μA max	
I _{GND}	150			μA typ	Digital Inputs= 5 V
		5	300	μA max	

¹ Temperature ranges are as follows: B Version: -40°C to +85°C; Y Version: -40°C to +125°C.

² Guaranteed by design, not subject to production test.

ABSOLUTE MAXIMUM RATINGS¹Table 4. Absolute Maximum Ratings ($T_A = 25^\circ\text{C}$, unless otherwise noted.)

Parameter	Rating
V_{DD} to V_{SS}	36 V
V_{DD} to GND	-0.3 V to +25 V
V_{SS} to GND	+0.3 V to -25 V
Analog, Digital Inputs ²	$V_{SS} - 0.3\text{ V}$ to $V_{DD} + 0.3\text{ V}$ or 20 mA, Whichever Occurs First
Continuous Current, S or D	30 mA
Peak Current, S or D (Pulsed at 1 ms, 10% Duty Cycle max)	100 mA
Operating Temperature Range	
Industrial (B Version)	-40° C to +85° C
Automotive (Y Version)	-40° C to +125° C
Storage Temperature Range	-65° C to +150° C
Junction Temperature	150° C

Parameter	Rating
TSSOP Package, Power Dissipation	450 mW
θ_{JA} , Thermal Impedance	150.4° C/W
θ_{JC} , Thermal Impedance	50° C/W
Lead Temperature, Soldering	
Vapor Phase (60 sec)	215° C
Infrared (15 sec)	220° C

¹ Stresses above those listed under Absolute Maximum Ratings may cause permanent damage to the device. This is a stress rating only; functional operation of the device at these or any other conditions above those listed in the operational sections of this specification is not implied. Exposure to absolute maximum rating conditions for extended periods may affect device reliability. Only one absolute maximum rating may be applied at any one time.

² Overvoltages at A, EN, S, or D will be clamped by internal diodes. Current should be limited to the maximum ratings given.

ESD CAUTION

ESD (electrostatic discharge) sensitive device. Electrostatic charges as high as 4000 V readily accumulate on the human body and test equipment and can discharge without detection. Although this product features proprietary ESD protection circuitry, permanent damage may occur on devices subjected to high energy electrostatic discharges. Therefore, proper ESD precautions are recommended to avoid performance degradation or loss of functionality.



PIN CONFIGURATIONS - TSSOP

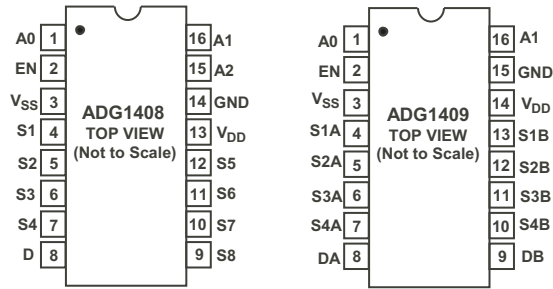

Figure 1. Pin Configurations - TSSOP

Table 5. ADG408 Truth Table

A2	A1	A0	EN	ON SWITCH
X	X	X	0	NONE
0	0	0	1	1
0	0	1	1	2
0	1	0	1	3
0	1	1	1	4
1	0	0	1	5
1	0	1	1	6
1	1	0	1	7
1	1	1	1	8

Table 6. ADG409 Truth Table

AI	A0	EN	ON SWITCH PAIR
X	X	0	NONE
0	0	1	1
0	1	1	2
1	0	1	3
1	1	1	4

TERMINOLOGY

V_{DD}	Most positive power supply potential.
V_{SS}	Most negative power supply potential in dual supplies. In single supply applications, it may be connected to ground.
GND	Ground (0 V) reference.
R_{ON}	Ohmic resistance between D and S.
ΔR_{ON}	Difference between the R_{ON} of any two channels.
I_S (OFF)	Source leakage current when the switch is off.
I_D (OFF)	Drain leakage current when the switch is off.
I_D, I_S (ON)	Channel leakage current when the switch is on.
V_D (v_s)	Analog voltage on terminals D, S.
C_S (OFF)	Channel input capacitance for OFF condition.
C_D (OFF)	Channel output capacitance for OFF condition.
C_D, C_S (ON)	ON switch capacitance.
C_{IN}	Digital input capacitance.
t_{ON} (EN)	Delay time between the 50% and 90% points of the digital input and switch ON condition.
t_{OFF} (EN)	Delay time between the 50% and 90% points of the digital input and switch OFF condition.
$t_{TRANSITION}$	Delay time between the 50% and 90% points of the digital inputs and the switch ON condition when switching from one address state to another.
t_{OPEN}	OFF time measured between the 80% point of both switches when switching from one address state to another.
V_{INL}	Maximum input voltage for Logic 0.
V_{INH}	Minimum input voltage for Logic 1.
I_{INL} (I_{INH})	Input current of the digital input.
I_{DD}	Positive supply current.
I_{SS}	Negative supply current.
Off Isolation	A measure of unwanted signal coupling through an OFF channel.
Charge Injection	A measure of the glitch impulse transferred from the digital input to the analog output during switching.
Bandwidth	The frequency at which the output is attenuated by 3dBs.
On Response	The Frequency response of the "ON" switch.
THD + N	The ratio of the harmonic amplitude plus noise of the signal to the fundamental.

TYPICAL PERFORMANCE CHARACTERISTICS

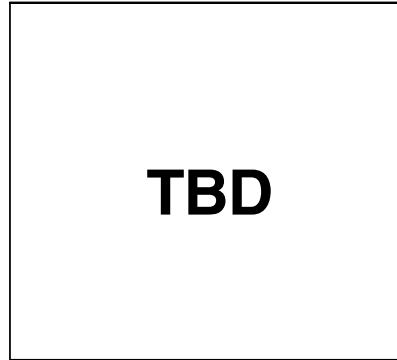
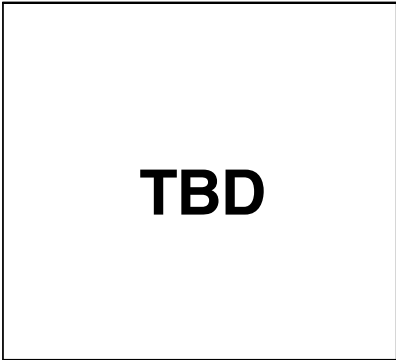

TPC 1. On Resistance as a Function of $V_D(V_S)$ for Single Supply

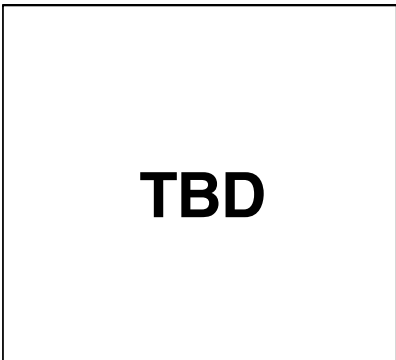

TPC 4. On Resistance as a Function of $V_D(V_S)$ for Different Temperatures, Single Supply

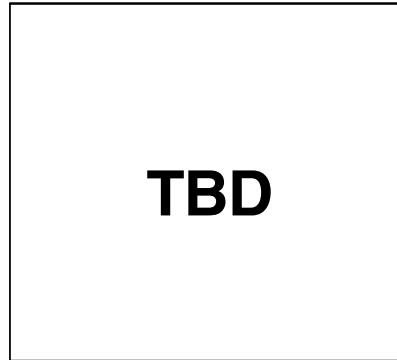

TPC 2. On Resistance as a Function of $V_D(V_S)$ for Dual Supply

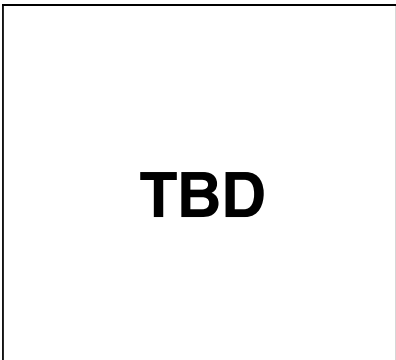

TPC 5. On Resistance as a Function of $V_D(V_S)$ for Different Temperatures, Dual Supply

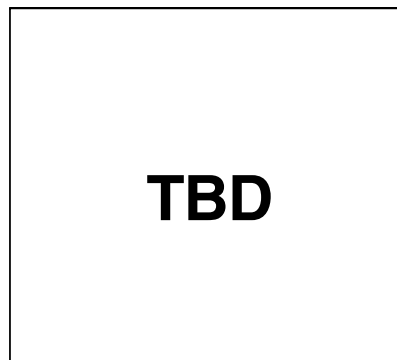

TPC 3. On Resistance as a Function of $V_D(V_S)$ for Different Temperatures, Single Supply

TPC 6. Leakage Currents as a Function of $V_b (V_s)$

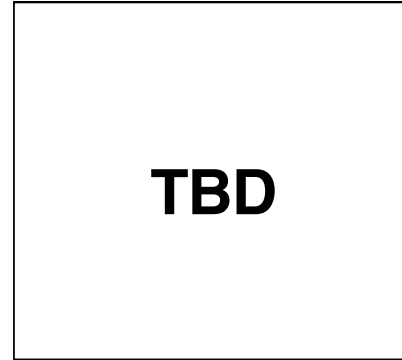
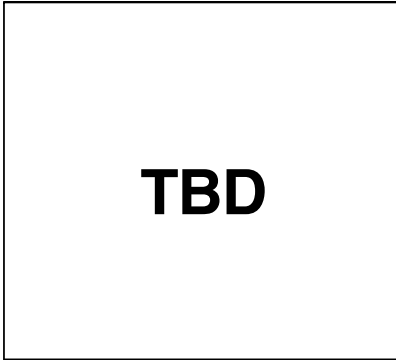

TPC 10. TON/TOFF Times vs. Temperature)

TPC 7. Leakage Currents as a function of Temperature

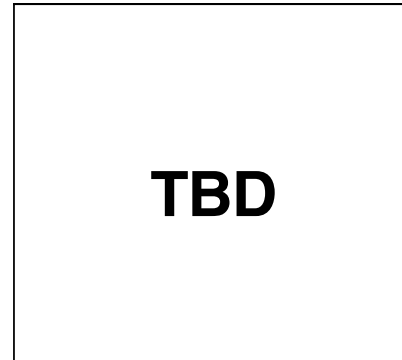
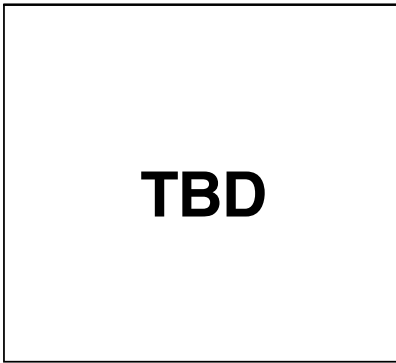

TPC 8 Supply Currents vs. Input Switching Frequency

TPC 11 Off Isolation vs. Frequency

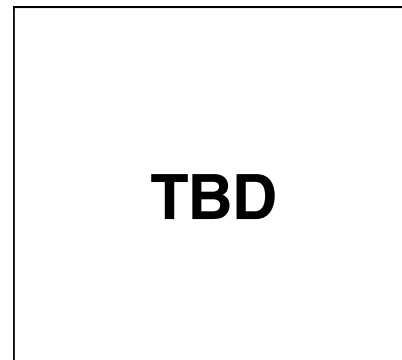
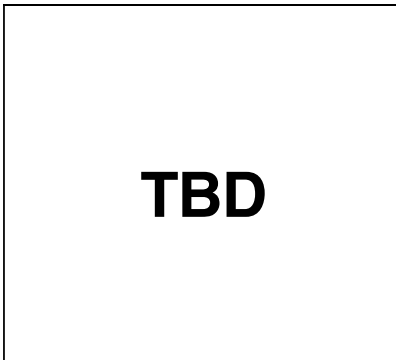

TPC 9 . Charge Injection vs. Source Voltage

TPC 12 Crosstalk vs. Frequency

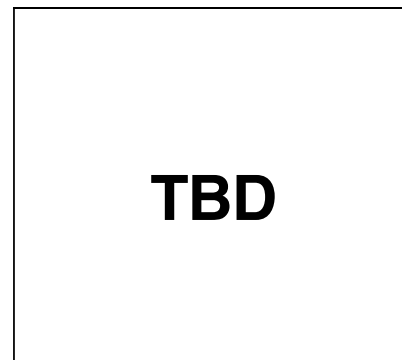

TPC 13. On Response vs. Frequency

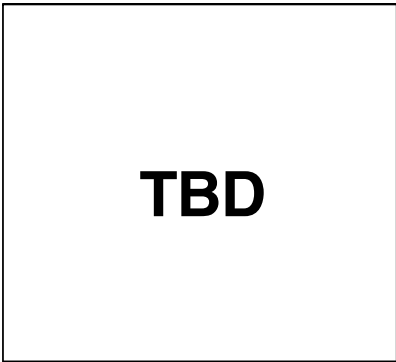

TPC 14. THD + N vs. Frequency

TEST CIRCUITS

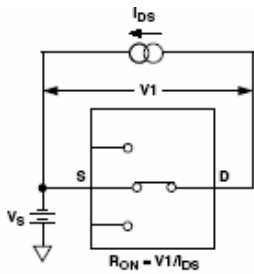

Test Circuit 1. On Resistance
Figure 2. Test Circuit 1. On Resistance

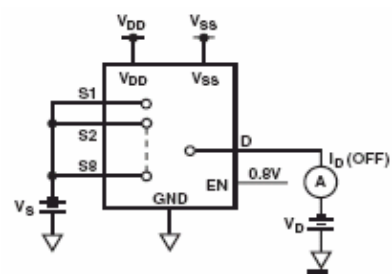

Test Circuit 3. I_D (OFF)
Figure 4. Test Circuit 3. I_D (OFF)

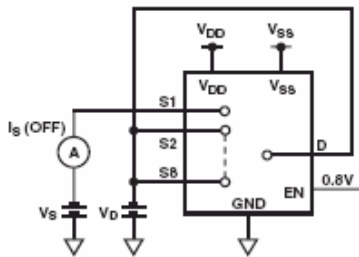

Test Circuit 2. I_S (OFF)
Figure 3. Test Circuit 2. I_S (OFF)

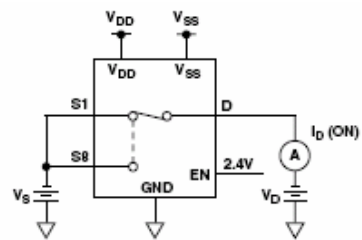

Test Circuit 4. I_D (ON)
Figure 5. Test Circuit 4. I_D (ON)

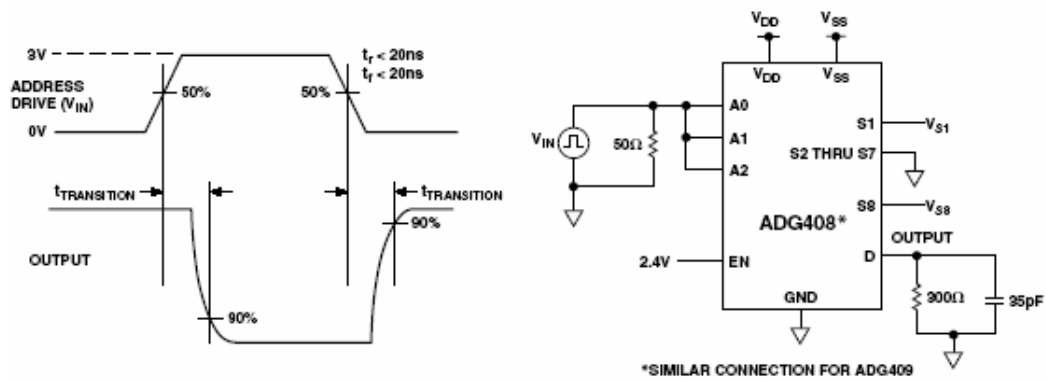

Test Circuit 5. Switching Time of Multiplexer, $t_{\text{TRANSITION}}$

Figure 6. Test Circuit 5. Switching Time of Multiplexer, $t_{\text{TRANSITION}}$

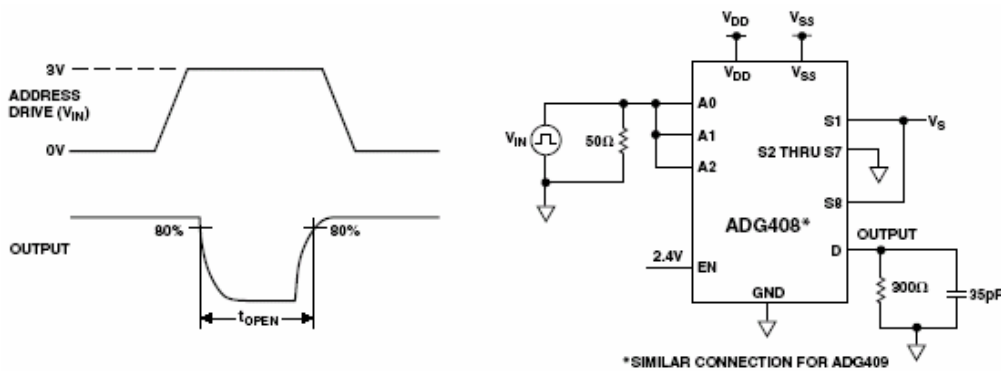

Test Circuit 6. Break-Before-Make Delay, t_{OPEN}

Figure 7. Test Circuit 6. Break-Before-Make Delay, t_{OPEN}

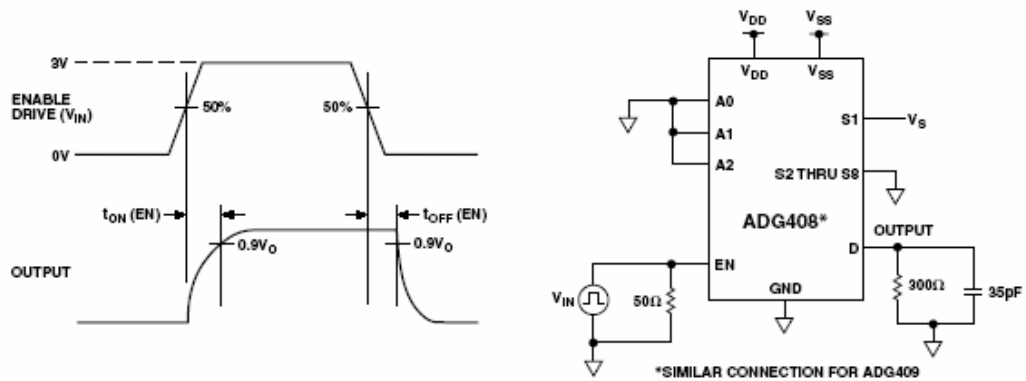

Test Circuit 7. Enable Delay, $t_{\text{ON}}(\text{EN})$, $t_{\text{OFF}}(\text{EN})$

Figure 8. Test Circuit 7. Enable Delay, $t_{\text{ON}}(\text{EN})$, $t_{\text{OFF}}(\text{EN})$

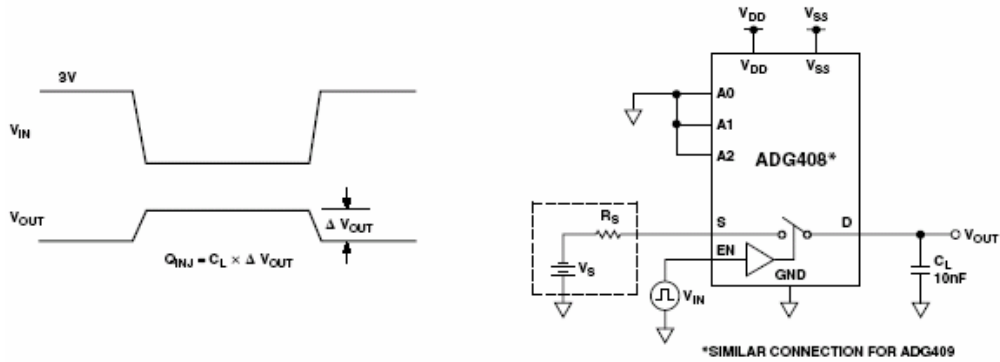

Test Circuit 8. Charge Injection

Figure 9. Test Circuit 8. Charge Injection

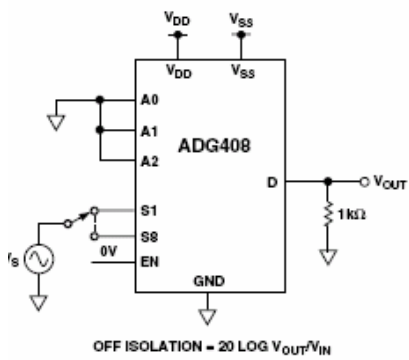

Test Circuit 9. OFF Isolation

Figure 10. Test Circuit 9. OFF Isolation

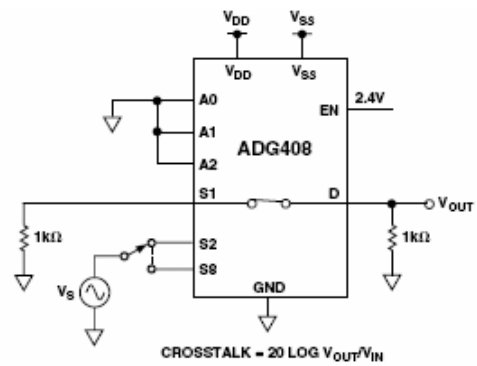

Test Circuit 10. Channel-to-Channel Crosstalk

Figure 11. Test Circuit 10. Channel-to-Channel Crosstalk

OUTLINE DIMENSIONS

16-Lead Thin Shrink Small Outline Package [TSSOP] (RU-16)

Dimensions shown in millimeters

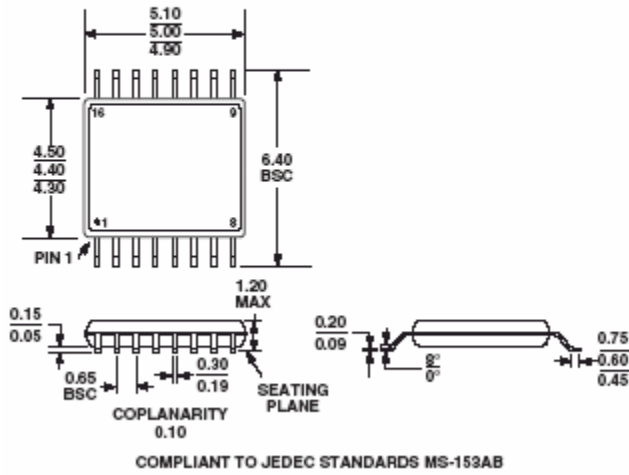

Figure 12. 16-Lead Thin Shrink Small Outline Package [TSSOP] (RU-16)

ORDERING GUIDE

Model	Temperature Range	Package Option¹
ADG1408BRU	-40°C to +125°C	RU-16
ADG1409BRU	-40°C to +125°C	RU-16

¹ RU = Thin Shrink Small Outline Package (TSSOP)