

### Features

- On-chip Hall sensor with two different sensitivity and hysteresis settings for AH276
- Built-in protecting diode only for chip reverse power connecting
- -20°C to 85°C operating temperature
- Lead Free Package: SIP-4L
- SIP-4L: Available in "Green" Molding Compound (No Br, Sb)
- Lead Free Finish/RoHS Compliant (Note 1)

### General Description

AH276 are integrated Hall sensors with output drivers, mainly designed for electronic commutation of brush-less DC Fan. This IC internally includes the regulator, protecting diode, Hall plate, amplifier, comparator, and a pair of complementary open-collector outputs (**DO**, **DOB**).

While the magnetic flux density (**B**) is larger than operate point (**Bop**), **DO** will turn on (low), and meanwhile **DOB** will turn off (high). Each output is latched until **B** is lower than release point (**Brp**), and then **DO**, **DOB** transfer each state.

For DC fan application, sometimes need to test power reverse connection condition. Internal diode only protects chip-side but not for coil-side. If necessary, add one external diode to block the reverse current from coil-side.

### Applications

- Dual-coil Brush-less DC Motor
- Dual-coil Brush-less DC Fan
- Revolution Counting
- Speed Measurement

### Ordering Information

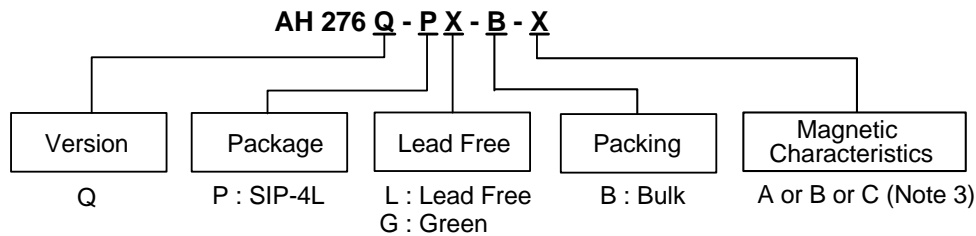

Device	Package Code	Packaging (Note 2)	Bulk		Magnetic Characteristics
			Quantity	Part Number Suffix	
AH276Q-PL-B-A	P	SIP-4L	1000	-B	A
AH276Q-PL-B-B	P	SIP-4L	1000	-B	B
AH276Q-PL-B-C	P	SIP-4L	1000	-B	C
AH276Q-PG-B-A	P	SIP-4L	1000	-B	A
AH276Q-PG-B-B	P	SIP-4L	1000	-B	B
AH276Q-PG-B-C	P	SIP-4L	1000	-B	C

- Notes:
1. EU Directive 2002/95/EC (RoHS). All applicable RoHS exemptions applied. Please visit our website at [http://www.diodes.com/products/lead\\_free.html](http://www.diodes.com/products/lead_free.html)
  2. Pad layout as shown on Diodes Inc. suggested pad layout document AP02001, which can be found on our website at <http://www.diodes.com/datasheets/ap02001.pdf>.
  3. Please refer to page 4 (Magnetic Characteristics table).

**Pin Assignment**

( Top View )

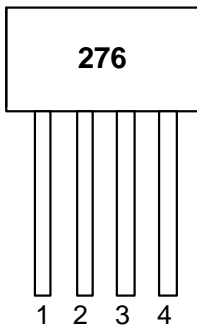

- 1 : Vcc
- 2 : DO
- 3 : DOB
- 4 : GND

**Pin Descriptions**

Pin Name	P/I/O	Pin #	Description
Vcc	P	1	Power Supply Input
DO	O	2	Output Pin
DOB	O	3	Output Pin
GND	P	4	Ground

**Block Diagram**

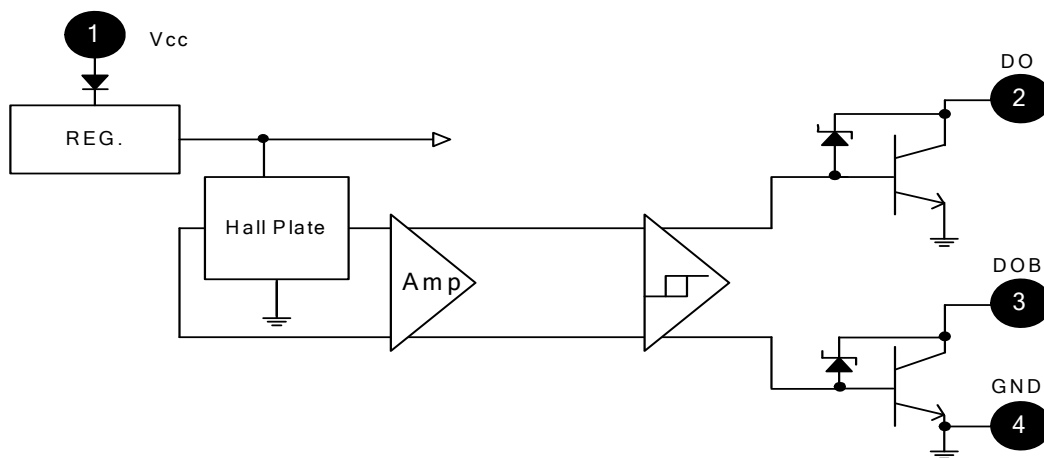

**Typical Application Circuit**

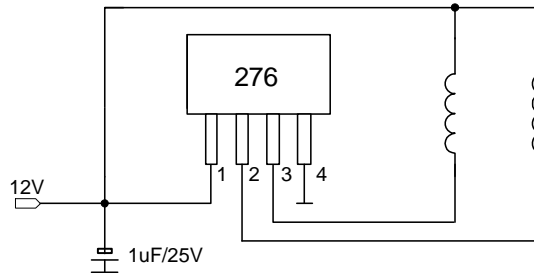

**Brush-less DC Fan**

**Absolute Maximum Ratings (@ T<sub>A</sub>=25°C)**

Symbol	Characteristics	Rating	Unit
V <sub>CC</sub>	Supply Voltage	20	V
V <sub>RCC</sub>	Reverse V <sub>CC</sub> Polarity Voltage	-20	V
B	Magnetic Flux Density	Unlimited	
I <sub>O</sub>	Output "on" current (Note 4)	Continuous	0.4
		Hold	0.5
		Peak (Start Up)	0.7
T <sub>S</sub>	Storage Temperature Range	-65~+150	°C
P <sub>D</sub>	Package Power Dissipation (SIP-4L)	550	mW
T <sub>J</sub>	Maximum Junction Temperature	150	°C
θ <sub>JC</sub>	Thermal Resistance (SIP-4L)	227	°C/W

Notes: 4. P<sub>D</sub> shall be within Safety Operation Area.

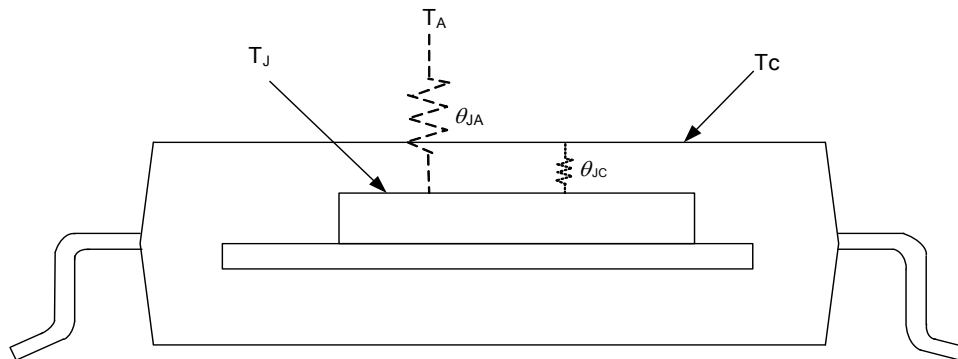

### Recommended Operating Conditions

Symbol	Characteristic	Conditions	Min	Max	Unit
V <sub>CC</sub>	Supply Voltage (Note 5)	Operating	3.5	20	V
T <sub>A</sub>	Operating Ambient Temperature	Operating	-20	85	°C

Notes: 5. The output DO/DOB is switching as magnetic field change (S>300G, N<-300G).

### Electrical Characteristics (T<sub>A</sub>=+25°C)

Symbol	Characteristic	Conditions	Min	Typ.	Max	Unit
V <sub>Z</sub>	Output Zener Breakdown	(Note 6)	-	35	-	V
V <sub>ce(sat)</sub>	Output Saturation Voltage	V <sub>CC</sub> =14V, I <sub>L</sub> =400mA	-	0.6	0.9	V
I <sub>ceX</sub>	Output Leakage Current	V <sub>ce</sub> =14V, V <sub>CC</sub> =14V	-	<0.1	10	μA
I <sub>CC</sub>	Supply Current	V <sub>CC</sub> =20V, Output Open	7	16	25	mA

Notes: 6. V<sub>Z</sub> is a typical value for design reference. V<sub>Z</sub> will vary with different coils design.

### Magnetic Characteristics ( $T_A=+25^{\circ}\text{C}$ , $V_{CC}=14\text{V}$ , Note 7)

#### A grade

Symbol	Characteristic	Min	Typ.	Max	Unit
Bop	Operate Point	10	-	50	Gauss
Brp	Release Point	-50	-	-10	Gauss
Bhy	Hysteresis	-	75	-	Gauss

#### B grade

Symbol	Characteristic	Min	Typ.	Max	Unit
Bop	Operate Point	5	-	70	Gauss
Brp	Release Point	-70	-	-5	Gauss
Bhy	Hysteresis	-	75	-	Gauss

#### C grade

Symbol	Characteristic	Min	Typ.	Max	Unit
Bop	Operate Point	-	-	100	Gauss
Brp	Release Point	-100	-	-	Gauss
Bhy	Hysteresis	-	75	-	Gauss

Notes: 7. Magnetic characteristics are for design information, which will vary with supply voltage, operating temperature and after soldering.

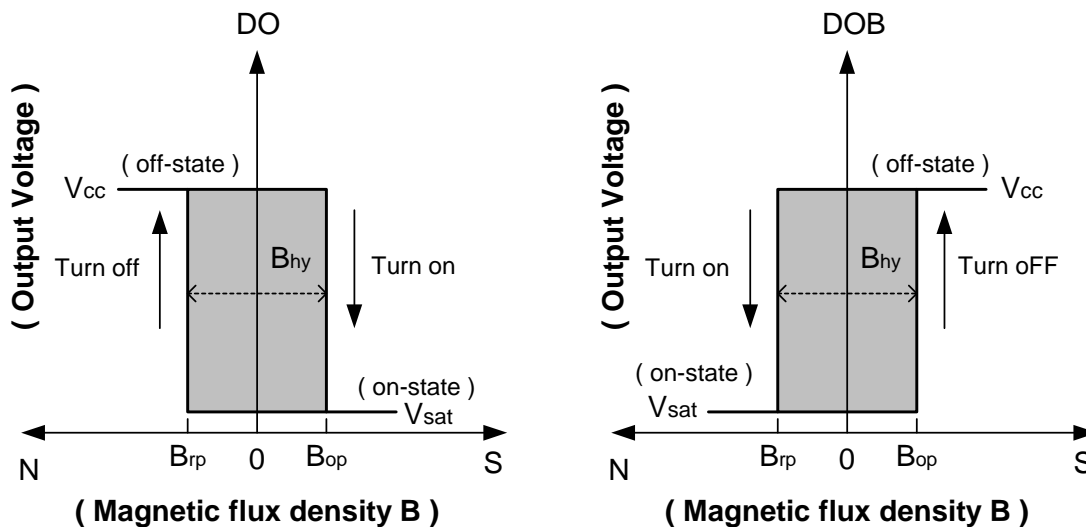

**Performance Characteristics**

$T_A$ (°C)	<b>25</b>	<b>50</b>	<b>60</b>	<b>70</b>	<b>80</b>	<b>85</b>	<b>90</b>	<b>95</b>	<b>100</b>
$P_D$ (mW)	550	440	396	352	308	286	264	242	220
$T_A$ (°C)	<b>105</b>	<b>110</b>	<b>115</b>	<b>120</b>	<b>125</b>	<b>130</b>	<b>135</b>	<b>140</b>	<b>150</b>
$P_D$ (mW)	198	176	154	132	110	88	66	44	0

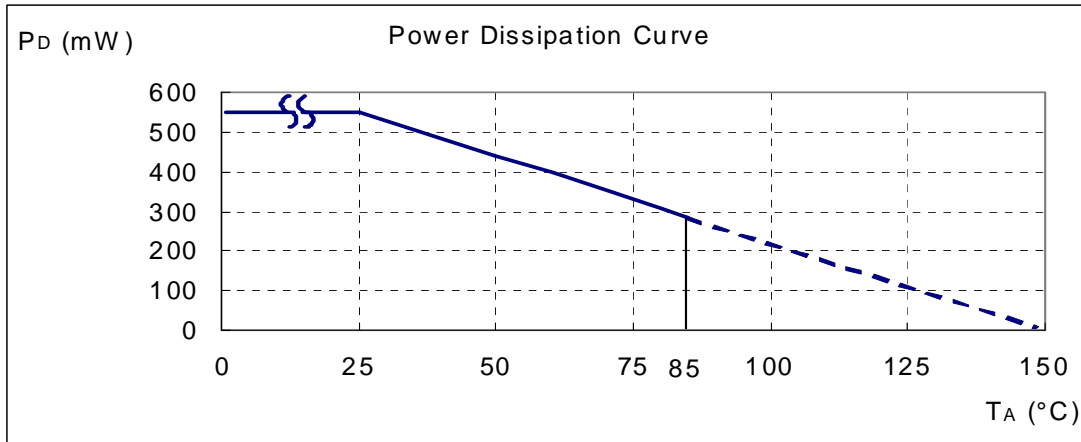

**Marking Information**

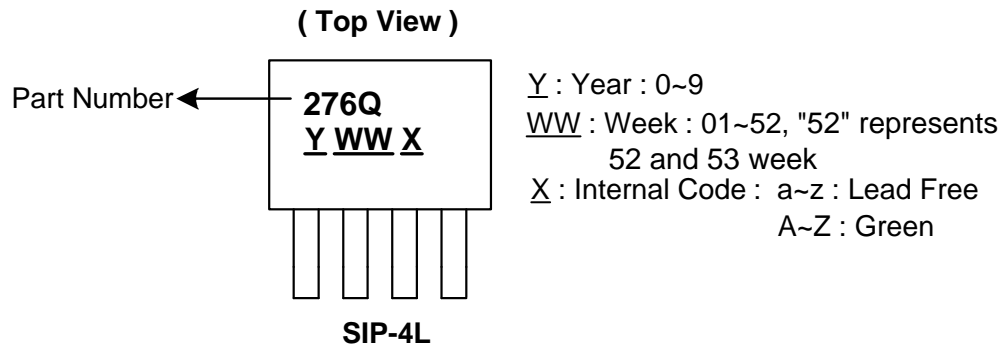

**Package Information** (All Dimensions in mm)

(1) Package type: SIP-4L

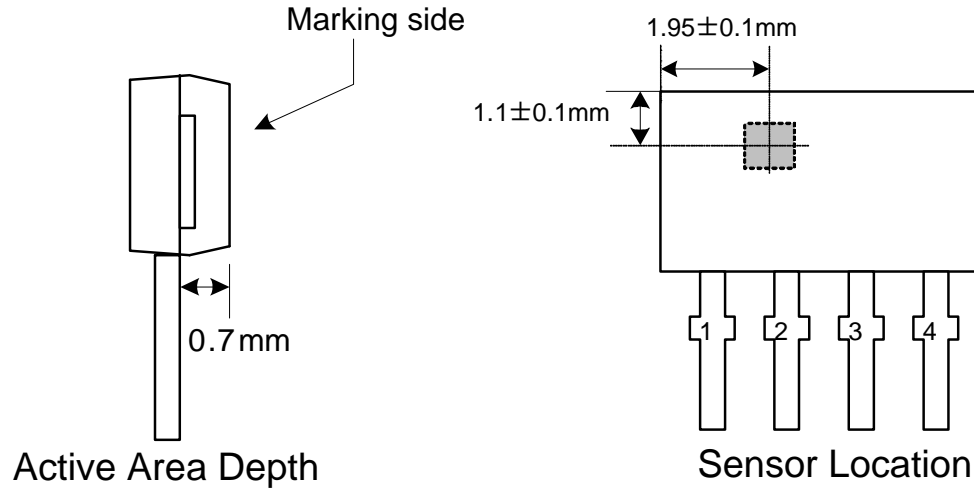

**Package Dimension**

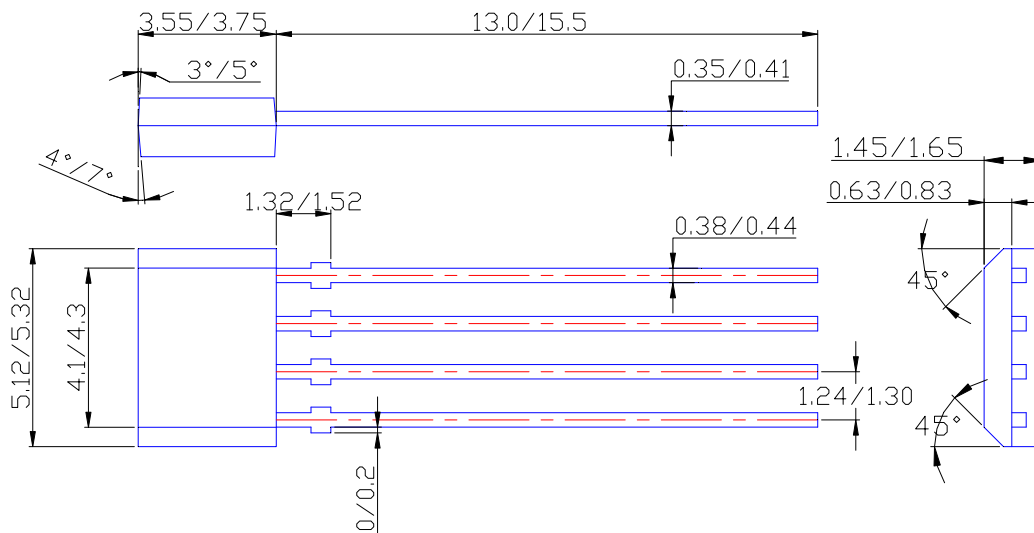

**IMPORTANT NOTICE**

DIODES INCORPORATED MAKES NO WARRANTY OF ANY KIND, EXPRESS OR IMPLIED, WITH REGARDS TO THIS DOCUMENT, INCLUDING, BUT NOT LIMITED TO, THE IMPLIED WARRANTIES OF MERCHANTABILITY AND FITNESS FOR A PARTICULAR PURPOSE (AND THEIR EQUIVALENTS UNDER THE LAWS OF ANY JURISDICTION).

Diodes Incorporated and its subsidiaries reserve the right to make modifications, enhancements, improvements, corrections or other changes without further notice to this document and any product described herein. Diodes Incorporated does not assume any liability arising out of the application or use of this document or any product described herein; neither does Diodes Incorporated convey any license under its patent or trademark rights, nor the rights of others. Any Customer or user of this document or products described herein in such applications shall assume all risks of such use and will agree to hold Diodes Incorporated and all the companies whose products are represented on Diodes Incorporated website, harmless against all damages.

Diodes Incorporated does not warrant or accept any liability whatsoever in respect of any products purchased through unauthorized sales channel.

Should Customers purchase or use Diodes Incorporated products for any unintended or unauthorized application, Customers shall indemnify and hold Diodes Incorporated and its representatives harmless against all claims, damages, expenses, and attorney fees arising out of, directly or indirectly, any claim of personal injury or death associated with such unintended or unauthorized application.

Products described herein may be covered by one or more United States, international or foreign patents pending. Product names and markings noted herein may also be covered by one or more United States, international or foreign trademarks.

**LIFE SUPPORT**

Diodes Incorporated products are specifically not authorized for use as critical components in life support devices or systems without the express written approval of the Chief Executive Officer of Diodes Incorporated. As used herein:

- A. Life support devices or systems are devices or systems which:
1. are intended to implant into the body, or
  2. support or sustain life and whose failure to perform when properly used in accordance with instructions for use provided in the labeling can be reasonably expected to result in significant injury to the user.
- B. A critical component is any component in a life support device or system whose failure to perform can be reasonably expected to cause the failure of the life support device or to affect its safety or effectiveness.

Customers represent that they have all necessary expertise in the safety and regulatory ramifications of their life support devices or systems, and acknowledge and agree that they are solely responsible for all legal, regulatory and safety-related requirements concerning their products and any use of Diodes Incorporated products in such safety-critical, life support devices or systems, notwithstanding any devices- or systems-related information or support that may be provided by Diodes Incorporated. Further, Customers must fully indemnify Diodes Incorporated and its representatives against any damages arising out of the use of Diodes Incorporated products in such safety-critical, life support devices or systems.

Copyright © 2009, Diodes Incorporated

[www.diodes.com](http://www.diodes.com)