

**150mA RF ULDO REGULATOR WITH ERROR FLAG****AP2203****General Description**

The AP2203 is a 150mA ULDO regulator, which provides ultra low dropout voltage (typically 165mV at 150mA), very low quiescent current (1 $\mu$ A maximum) in shutdown mode and excellent power supply ripple rejection (PSRR 75dB at 100Hz) in battery powered applications, such as handsets and PDAs and in noise sensitive applications, such as RF electronics.

The AP2203 also features an undervoltage monitor with an error flag output, logic compatible enable/shutdown control inputs, a low power shutdown mode for extended battery life, over current protection, over temperature protection as well as reversed-battery protection.

The AP2203 has 2.5V, 3.0V and 3.3V versions.

The AP2203 is available in space saving 5-pin SOT-23-5 package.

**Features**

- Error Flag to Indicate Undervoltage Fault
- Up to 150mA Regulator Output
- Low Quiescent Current
- Low Dropout Voltage:  $V_{DROPO}=165mV$  at 150mA
- High Output Accuracy:  $\pm 1\%$
- Good Ripple Rejection Ability: 75dB at 100Hz and  $I_{OUT}=100\mu A$
- Tight Load and Line Regulation
- Low Temperature Coefficient
- Over Current Protection
- Thermal Protection
- Reverse-battery Protection
- Zero Off-mode Current
- Logic-controlled Enable

**Applications**

- Cellular Phones
- Cordless Phones
- Wireless Communicators
- PDAs / Palmtops
- Consumer Electronics

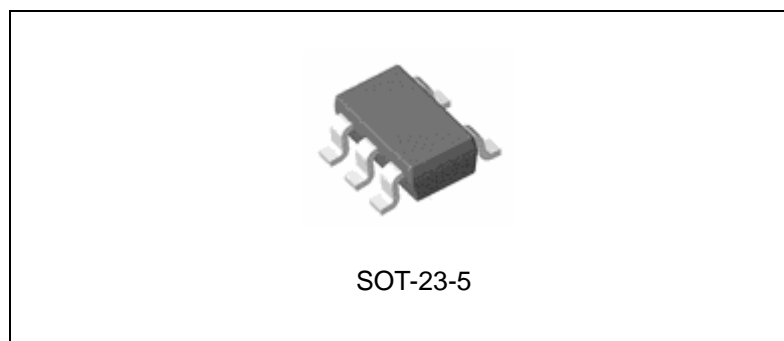

Figure 1. Package Type of AP2203

**150mA RF ULDO REGULATOR WITH ERROR FLAG****AP2203****Pin Configuration**K Package  
(SOT-23-5)

Figure 2. Pin Configuration of AP2203 (Top View)

**Pin Description**

Pin Number	Pin Name	Function
1	$V_{IN}$	Input voltage
2	GND	Ground
3	EN	Enable input: CMOS or TTL compatible input. Logic high=enable, logic low=shutdown
4	FLAG	Error flag (Output pin): Open-collector output. Active low indicates an output undervoltage condition
5	$V_{OUT}$	Regulated output voltage

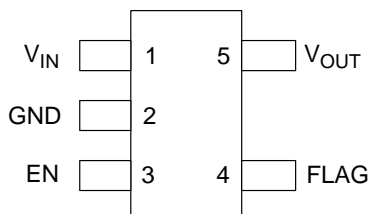

**150mA RF ULDO REGULATOR WITH ERROR FLAG** **AP2203**

**Functional Block Diagram**

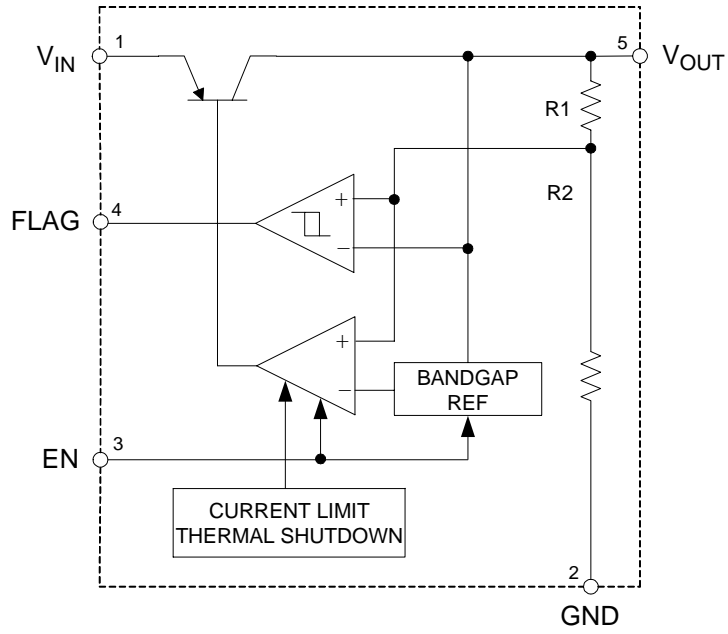

Figure 3. Functional Block Diagram of AP2203



**150mA RF ULDO REGULATOR WITH ERROR FLAG**

**AP2203**

**Ordering Information**

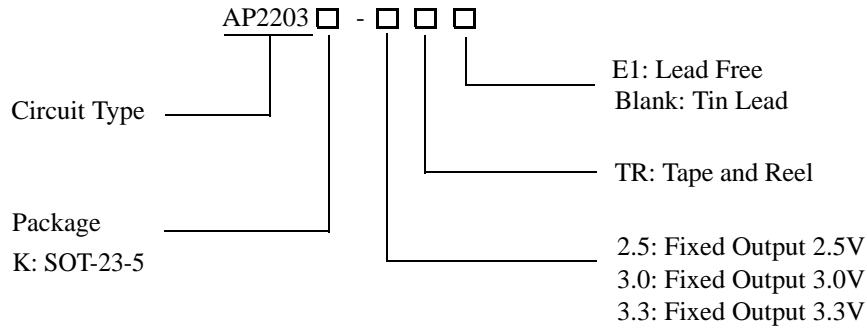

Package	Temperature Range	Part Number		Marking ID		Packing Type
		Tin Lead	Lead Free	Tin Lead	Lead Free	
SOT-23-5	-40 to 125°C	AP2203K-2.5TR	AP2203K-2.5TRE1	K3C	E3C	Tape & Reel
		AP2203K-3.0TR	AP2203K-3.0TRE1	K3F	E3F	Tape & Reel
		AP2203K-3.3TR	AP2203K-3.3TRE1	K3G	E3G	Tape & Reel

BCD Semiconductor's Pb-free products, as designated with "E1" suffix in the part number, are RoHS compliant.

**150mA RF ULDO REGULATOR WITH ERROR FLAG****AP2203****Absolute Maximum Ratings (Note 1)**

Parameter	Symbol	Value	Unit
Supply Input Voltage	$V_{IN}$	15	V
Enable Input Voltage	$V_{EN}$	15	V
Power Dissipation	$P_D$	Internally Limited (Thermal Protection)	W
Lead Temperature (Soldering, 5sec)	$T_{LEAD}$	260	°C
Storage Temperature	$T_{STG}$	-65 to 150	°C
ESD (Machine Model)		300	V
Thermal Resistance (No Heatsink)	$\theta_{JA}$	200	°C/W

Note 1: Stresses greater than those listed under "Absolute Maximum Ratings" may cause permanent damage to the device. These are stress ratings only, and functional operation of the device at these or any other conditions beyond those indicated under "Recommended Operating Conditions" is not implied. Exposure to "Absolute Maximum Ratings" for extended periods may affect device reliability.

**Recommended Operating Conditions**

Parameter	Symbol	Min	Max	Unit
Supply Input Voltage	$V_{IN}$	2.5	13.2	V
Enable Input Voltage	$V_{EN}$	0	13.2	V
Operating Junction Temperature	$T_J$	-40	125	°C



**150mA RF ULDO REGULATOR WITH ERROR FLAG**

**AP2203**

**Electrical Characteristics**

**AP2203-2.5V Electrical Characteristics**

$V_{IN}=3.5V$ ,  $I_{OUT}=100\mu A$ ,  $C_{OUT}=2.2\mu F$ ,  $V_{EN}\geq 2.0V$ ,  $T_J=25^\circ C$ , **Bold** typeface applies over  $-40^\circ C < T_J < 125^\circ C$  (note 2), unless otherwise specified.

Parameter	Symbol	Conditions	Min	Typ	Max	Unit
Output Voltage Accuracy	$\Delta V_{OUT}/V_{OUT}$	Variation from specified $V_{OUT}$	-1		1	%
			-2		2	
Output Voltage Temperature Coefficient (Note 3)	$\Delta V_{OUT}/\Delta T$			<b>120</b>		$\mu V/^\circ C$
	$(\Delta V_{OUT}/V_{OUT})/\Delta T$			<b>48</b>		ppm/ $^\circ C$
Line Regulation	$V_{RLINE}$	$V_{IN}=3.5V$ to 13.2V		1.5	4.5	mV
					<b>12</b>	
Load Regulation	$V_{RLOAD}$	$I_{OUT}=0.1mA$ to 150mA (Note 4)		1	6	mV
					<b>15</b>	
Dropout Voltage (Note 5)	$V_{DROP}$	$I_{OUT}=100\mu A$		15	50	mV
				<b>70</b>		
		$I_{OUT}=50mA$		110	150	
				<b>230</b>		
		$I_{OUT}=100mA$		140	250	
					<b>300</b>	
		$I_{OUT}=150mA$		165	275	
					<b>350</b>	
Quiescent Current	$I_Q$	$V_{EN} \leq 0.4V$ (shutdown)		0.01	1	$\mu A$
		$V_{EN} \leq 0.18V$ (shutdown)			<b>5</b>	
Ground Pin Current (Note 6)	$I_{GND}$	$V_{EN} \geq 2.0V$ , $I_{OUT}=100\mu A$		100	150	$\mu A$
				<b>180</b>		
		$V_{EN} \geq 2.0V$ , $I_{OUT}=50mA$		350	600	
				<b>800</b>		
		$V_{EN} \geq 2.0V$ , $I_{OUT}=100mA$		600	1000	
					<b>1500</b>	
		$V_{EN} \geq 2.0V$ , $I_{OUT}=150mA$		1300	1900	
					<b>2500</b>	
Ripple Rejection	PSRR	frequency=100Hz, $I_{OUT}=100\mu A$		75		dB
Current Limit	$I_{LIMIT}$	$V_{OUT}=0V$		<b>450</b>	650	mA

**150mA RF ULDO REGULATOR WITH ERROR FLAG****AP2203****Electrical Characteristics (Continued)****AP2203-2.5V Electrical Characteristics**

$V_{IN}=3.5V$ ,  $I_{OUT}=100\mu A$ ,  $C_{OUT}=2.2\mu F$ ,  $V_{EN}\geq 2.0V$ ,  $T_J=25^\circ C$ , **Bold** typeface applies over  $-40^\circ C < T_J < 125^\circ C$  (note 2), unless otherwise specified.

Parameter	Symbol	Conditions	Min	Typ	Max	Unit
Enable Input Logic-low Voltage	$V_{IL}$	Regulator shutdown			0.4	V
					<b>0.18</b>	
Enable Input Logic-high Voltage	$V_{IH}$	Regulator enabled	<b>2.0</b>			V
Enable Input Logic-low Current	$I_{IL}$	$V_{IL}\leq 0.4V$		0.01	-1	$\mu A$
		$V_{IL}\leq 0.18V$			<b>-2</b>	
Enable Input Logic-high Current	$I_{IH}$	$V_{IL}\geq 2.0V$		5	20	$\mu A$
		$V_{IL}\geq 2.0V$			<b>25</b>	
Flag Threshold	$V_{ERR}$	Undervoltage condition (below nominal) (Note 7)	-10	-6	-2	%
Output Logic-low Voltage (Note 8)	$V_{OL}$	$I_{FL}=1mA$ Undervoltage condition		0.2	<b>0.4</b>	V
Flag Leakage Current	$I_{FL}$	Flag off, $V_{FLAG}=0V$ to $13.2V$	-0.1	0.1	1	$\mu A$

Note 2: Specifications in bold type are limited to  $-40^\circ C < T_J < 125^\circ C$ . Limits over temperature are guaranteed by design, but not tested in production.

Note 3: Output voltage temperature coefficient is defined as the worst case voltage change divided by the total temperature range.

Note 4: Regulation is measured at constant junction temperature using low duty cycle pulse testing. Parts are tested for load regulation in the load range from 0.1mA to 150mA. Changes in output voltage due to heating effects are covered by the thermal regulation specification.

Note 5: Dropout voltage is defined as the input to output differential at which the output voltage drops 2% below its nominal value measured at 1V differential.

Note 6: Ground pin current is the regulator quiescent current plus pass transistor base current. The total current drawn from the supply is the sum of the load current plus the ground pin current.

Note 7: The error flag comparator includes 2.5% hysteresis.

Note 8: The FLAG pin will be enabled if EN pin voltage is high, and disabled if EN pin voltage is low.



**150mA RF ULDO REGULATOR WITH ERROR FLAG**

**AP2203**

**Electrical Characteristics (Continued)**

**AP2203-3.0V Electrical Characteristics**

$V_{IN}=4V$ ,  $I_{OUT}=100\mu A$ ,  $C_{OUT}=2.2\mu F$ ,  $V_{EN}\geq 2.0V$ ,  $T_J=25^\circ C$ , **Bold** typeface applies over  $-40^\circ C < T_J < 125^\circ C$  (note 2), unless otherwise specified.

Parameter	Symbol	Conditions	Min	Typ	Max	Unit
Output Voltage Accuracy	$\Delta V_{OUT}/V_{OUT}$	Variation from specified $V_{OUT}$	-1		1	%
			-2		<b>2</b>	
Output Voltage Temperature Coefficient (Note 3)	$\Delta V_{OUT}/\Delta T$			<b>120</b>		$\mu V/^\circ C$
	$(\Delta V_{OUT}/V_{OUT})/\Delta T$			<b>40</b>		ppm/ $^\circ C$
Line Regulation	$V_{RLINE}$	$V_{IN}=4V$ to 13.2V		1.5	4.5	mV
					<b>12</b>	
Load Regulation	$V_{RLOAD}$	$I_{OUT}=0.1mA$ to 150mA (Note 4)		1	6	mV
					<b>15</b>	
Dropout Voltage (Note 5)	$V_{DROP}$	$I_{OUT}=100\mu A$		15	50	mV
				<b>70</b>		
		$I_{OUT}=50mA$		110	150	
				<b>230</b>		
		$I_{OUT}=100mA$		140	250	
					<b>300</b>	
		$I_{OUT}=150mA$		165	275	
					<b>350</b>	
Quiescent Current	$I_Q$	$V_{EN} \leq 0.4V$ (shutdown)		0.01	1	$\mu A$
		$V_{EN} \leq 0.18V$ (shutdown)			<b>5</b>	
Ground Pin Current (Note 6)	$I_{GND}$	$V_{EN} \geq 2.0V$ , $I_{OUT}=100\mu A$		100	150	$\mu A$
					<b>180</b>	
		$V_{EN} \geq 2.0V$ , $I_{OUT}=50mA$		350	600	
					<b>800</b>	
		$V_{EN} \geq 2.0V$ , $I_{OUT}=100mA$		600	1000	
					<b>1500</b>	
		$V_{EN} \geq 2.0V$ , $I_{OUT}=150mA$		1300	1900	
					<b>2500</b>	
Ripple Rejection	PSRR	frequency=100Hz, $I_{OUT}=100\mu A$		75		dB
Current Limit	$I_{LIMIT}$	$V_{OUT}=0V$		<b>450</b>	650	mA



**150mA RF ULDO REGULATOR WITH ERROR FLAG****AP2203****Electrical Characteristics (Continued)****AP2203-3.0V Electrical Characteristics**

$V_{IN}=4V$ ,  $I_{OUT}=100\mu A$ ,  $C_{OUT}=2.2\mu F$ ,  $V_{EN}\geq 2.0V$ ,  $T_J=25^\circ C$ , **Bold** typeface applies over  $-40^\circ C < T_J < 125^\circ C$  (note 2), unless otherwise specified.

Parameter	Symbol	Conditions	Min	Typ	Max	Unit
Enable Input Logic-low Voltage	$V_{IL}$	Regulator shutdown			0.4	V
					<b>0.18</b>	
Enable Input Logic-high Voltage	$V_{IH}$	Regulator enabled	<b>2.0</b>			V
Enable Input Logic-low Current	$I_{IL}$	$V_{IL} \leq 0.4V$		0.01	-1	$\mu A$
		$V_{IL} \leq 0.18V$			<b>-2</b>	
Enable Input Logic-high Current	$I_{IH}$	$V_{IL} \geq 2.0V$		5	20	$\mu A$
		$V_{IL} \geq 2.0V$			<b>25</b>	
Flag Threshold	$V_{ERR}$	Undervoltage condition (below nominal) (Note 7)	-10	-6	-2	%
Output Logic-low Voltage (Note 8)	$V_{OL}$	$I_{FL}=1mA$ Undervoltage condition		0.2	<b>0.4</b>	V
Flag Leakage Current	$I_{FL}$	Flag off, $V_{FLAG}=0V$ to $13.2V$	-0.1	0.1	1	$\mu A$

Note 2: Specifications in bold type are limited to  $-40^\circ C < T_J < 125^\circ C$ . Limits over temperature are guaranteed by design, but not tested in production.

Note 3: Output voltage temperature coefficient is defined as the worst case voltage change divided by the total temperature range.

Note 4: Regulation is measured at constant junction temperature using low duty cycle pulse testing. Parts are tested for load regulation in the load range from 0.1mA to 150mA. Changes in output voltage due to heating effects are covered by the thermal regulation specification.

Note 5: Dropout voltage is defined as the input to output differential at which the output voltage drops 2% below its nominal value measured at 1V differential.

Note 6: Ground pin current is the regulator quiescent current plus pass transistor base current. The total current drawn from the supply is the sum of the load current plus the ground pin current.

Note 7: The error flag comparator includes 2.5% hysteresis.

Note 8: The FLAG pin will be enabled if EN pin voltage is high, and disabled if EN pin voltage is low.



**150mA RF ULDO REGULATOR WITH ERROR FLAG**

**AP2203**

**Electrical Characteristics (Continued)**

**AP2203-3.3V Electrical Characteristics**

$V_{IN}=4.3V$ ,  $I_{OUT}=100\mu A$ ,  $C_{OUT}=2.2\mu F$ ,  $V_{EN}\geq 2.0V$ ,  $T_J=25^\circ C$ , **Bold** typeface applies over  $-40^\circ C < T_J < 125^\circ C$  (note 2), unless otherwise specified.

Parameter	Symbol	Conditions	Min	Typ	Max	Unit
Output Voltage Accuracy	$\Delta V_{OUT}/V_{OUT}$	Variation from specified $V_{OUT}$	-1		1	%
			-2		2	
Output Voltage Temperature Coefficient (Note 3)	$\Delta V_{OUT}/\Delta T$			<b>120</b>		$\mu V/^\circ C$
	$(\Delta V_{OUT}/V_{OUT})/\Delta T$			<b>36</b>		ppm/ $^\circ C$
Line Regulation	$V_{RLINE}$	$V_{IN}=4.3V$ to 13.2V		1.5	4.5	mV
					<b>12</b>	
Load Regulation	$V_{RLOAD}$	$I_{OUT}=0.1mA$ to 150mA (Note 4)		1	6	mV
					<b>15</b>	
Dropout Voltage (Note 5)	$V_{DROP}$	$I_{OUT}=100\mu A$		15	50	mV
				<b>70</b>		
		$I_{OUT}=50mA$		110	150	
				<b>230</b>		
		$I_{OUT}=100mA$		140	250	
					<b>300</b>	
		$I_{OUT}=150mA$		165	275	
					<b>350</b>	
Quiescent Current	$I_Q$	$V_{EN} \leq 0.4V$ (shutdown)		0.01	1	$\mu A$
		$V_{EN} \leq 0.18V$ (shutdown)			<b>5</b>	
Ground Pin Current (Note 6)	$I_{GND}$	$V_{EN} \geq 2.0V$ , $I_{OUT}=100\mu A$		100	150	$\mu A$
				<b>180</b>		
		$V_{EN} \geq 2.0V$ , $I_{OUT}=50mA$		350	600	
				<b>800</b>		
		$V_{EN} \geq 2.0V$ , $I_{OUT}=100mA$		600	1000	
					<b>1500</b>	
		$V_{EN} \geq 2.0V$ , $I_{OUT}=150mA$		1300	1900	
					<b>2500</b>	
Ripple Rejection	PSRR	frequency=100Hz, $I_{OUT}=100\mu A$		75		dB
Current Limit	$I_{LIMIT}$	$V_{OUT}=0V$		<b>450</b>	650	mA

**150mA RF ULDO REGULATOR WITH ERROR FLAG****AP2203****Electrical Characteristics (Continued)****AP2203-3.3V Electrical Characteristics**

$V_{IN}=4.3V$ ,  $I_{OUT}=100\mu A$ ,  $C_{OUT}=2.2\mu F$ ,  $V_{EN}\geq 2.0V$ ,  $T_J=25^\circ C$ , **Bold** typeface applies over  $-40^\circ C < T_J < 125^\circ C$  (note 2), unless otherwise specified.

Parameter	Symbol	Conditions	Min	Typ	Max	Unit
Enable Input Logic-low Voltage	$V_{IL}$	Regulator shutdown			0.4	V
					<b>0.18</b>	
Enable Input Logic-high Voltage	$V_{IH}$	Regulator enabled	<b>2.0</b>			V
Enable Input Logic-low Current	$I_{IL}$	$V_{IL} \leq 0.4V$		0.01	-1	$\mu A$
		$V_{IL} \leq 0.18V$			<b>-2</b>	
Enable Input Logic-high Current	$I_{IH}$	$V_{IL} \geq 2.0V$		5	20	$\mu A$
		$V_{IL} \geq 2.0V$			<b>25</b>	
Flag Threshold	$V_{ERR}$	Undervoltage condition (below nominal) (Note 7)	-10	-6	-2	%
Output Logic-low Voltage (Note 8)	$V_{OL}$	$I_{FL}=1mA$ Undervoltage condition		0.2	<b>0.4</b>	V
Flag Leakage Current	$I_{FL}$	Flag off, $V_{FLAG}=0V$ to $13.2V$	-0.1	0.1	1	$\mu A$

Note 2: Specifications in bold type are limited to  $-40^\circ C < T_J < 125^\circ C$ . Limits over temperature are guaranteed by design, but not tested in production.

Note 3: Output voltage temperature coefficient is defined as the worst case voltage change divided by the total temperature range.

Note 4: Regulation is measured at constant junction temperature using low duty cycle pulse testing. Parts are tested for load regulation in the load range from 0.1mA to 150mA. Changes in output voltage due to heating effects are covered by the thermal regulation specification.

Note 5: Dropout voltage is defined as the input to output differential at which the output voltage drops 2% below its nominal value measured at 1V differential.

Note 6: Ground pin current is the regulator quiescent current plus pass transistor base current. The total current drawn from the supply is the sum of the load current plus the ground pin current.

Note 7: The error flag comparator includes 2.5% hysteresis.

Note 8: The FLAG pin will be enabled if EN pin voltage is high, and disabled if EN pin voltage is low.



**150mA RF ULDO REGULATOR WITH ERROR FLAG**

**AP2203**

**Typical Performance Characteristics**

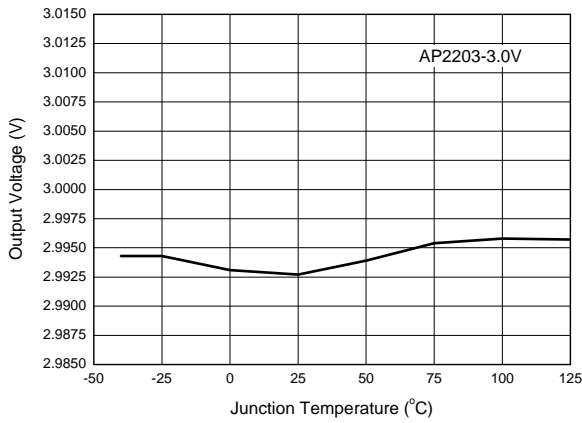

Figure 4. Output Voltage vs. Junction Temperature

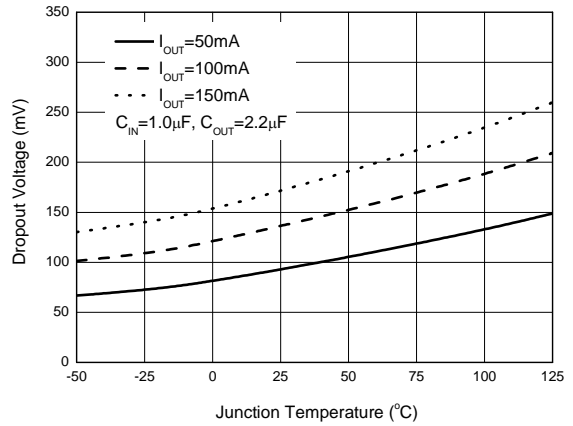

Figure 5. Dropout Voltage vs. Junction Temperature

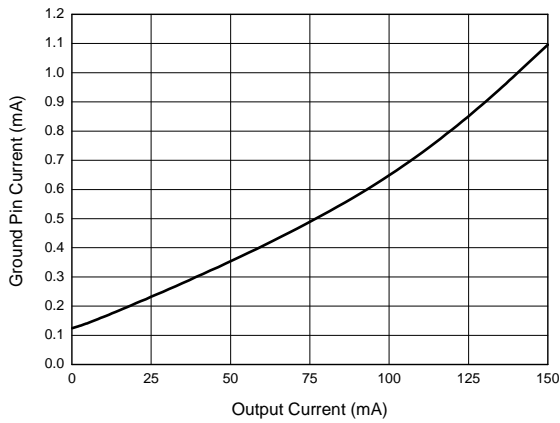

Figure 6. Ground Pin Current vs. Output Current

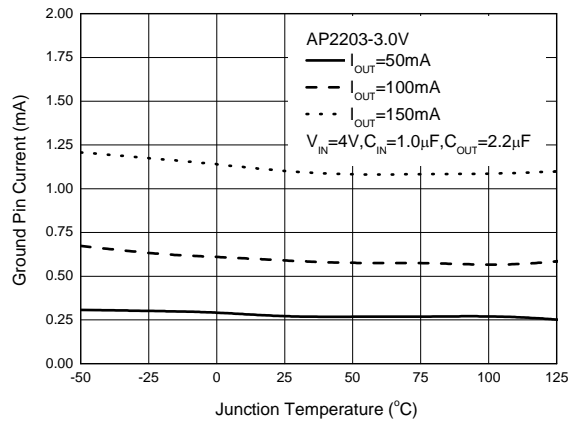

Figure 7. Ground Pin Current vs. Junction Temperature



**150mA RF ULDO REGULATOR WITH ERROR FLAG**

**AP2203**

**Typical Performance Characteristics (Continued)**

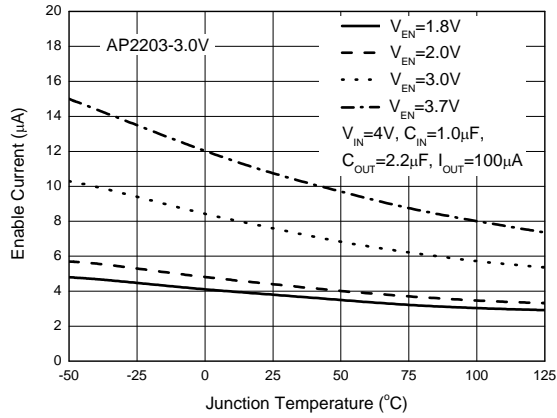

Figure 8. Enable Current vs. Junction Temperature

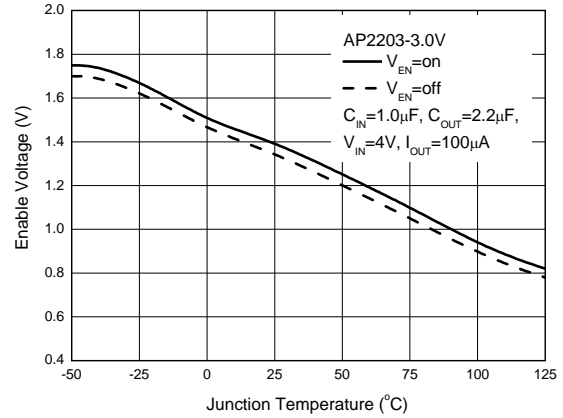

Figure 9. Enable Voltage vs. Junction Temperature

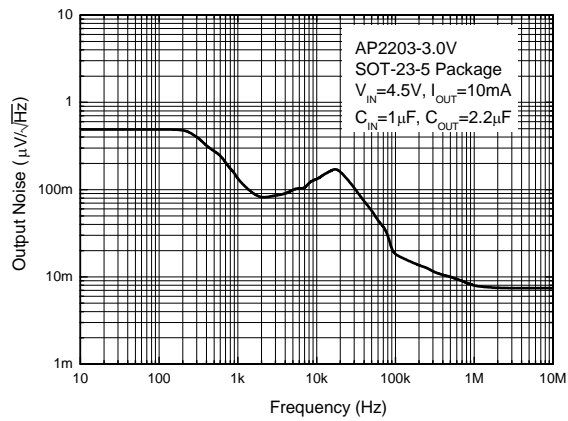

Figure 10. Output Noise vs. Frequency

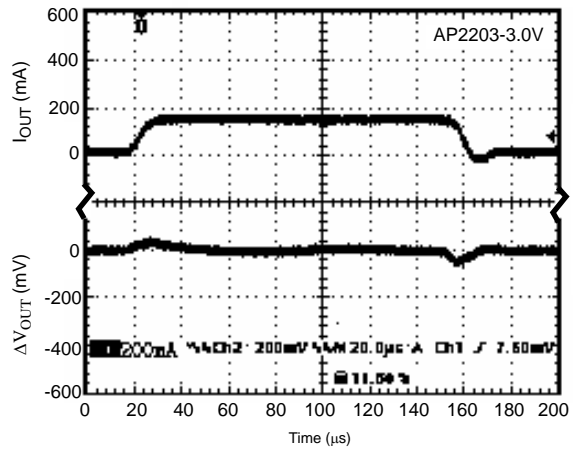

Figure 11. Load Transient  
(Conditions:  $V_{IN}=4V$ ,  $V_{EN}=2V$ ,  $I_{OUT}=5mA$  to  $200mA$ ,  $C_{IN}=1\mu F$ ,  $C_{OUT}=2.2\mu F$ )



**150mA RF ULDO REGULATOR WITH ERROR FLAG**

**AP2203**

**Typical Performance Characteristics (Continued)**

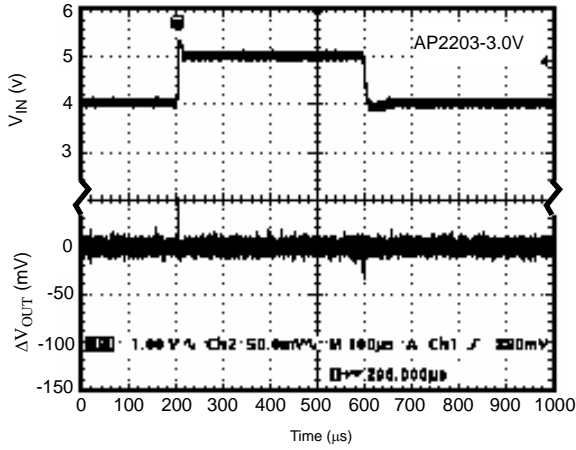

Figure 12. Line Transient  
(Conditions:  $V_{IN}=4$  to  $5V$ ,  $V_{EN}=2V$ ,  $I_{OUT}=100\mu A$ ,  $C_{IN}=1\mu F$ ,  $C_{OUT}=10\mu F$ )

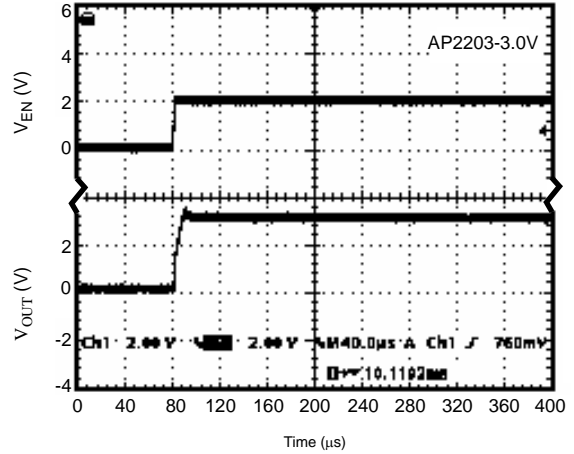

Figure 13.  $V_{EN}(on)$  vs.  $V_{OUT}$   
(Conditions:  $V_{EN}=0$  to  $2V$ ,  $V_{IN}=4V$ ,  $I_{OUT}=30mA$ ,  $C_{IN}=1.0\mu F$ ,  $C_{OUT}=2.2\mu F$ )

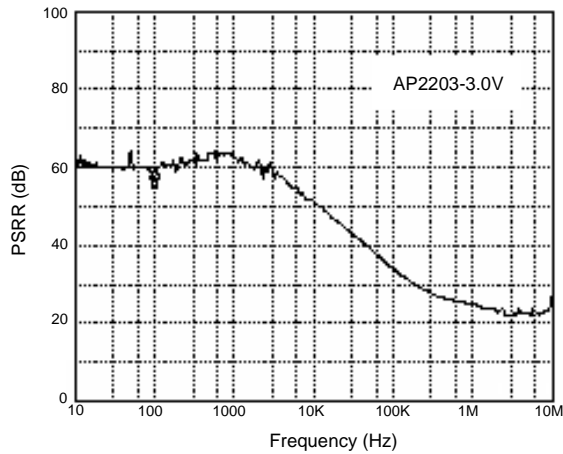

Figure 14. PSRR vs. Frequency  
(Conditions:  $C_{IN}=1.0\mu F$ ,  $C_{OUT}=2.2\mu F$ ,  $V_{IN}=4V$ ,  $I_{OUT}=100mA$ ,  $V_{EN}=2V$ )

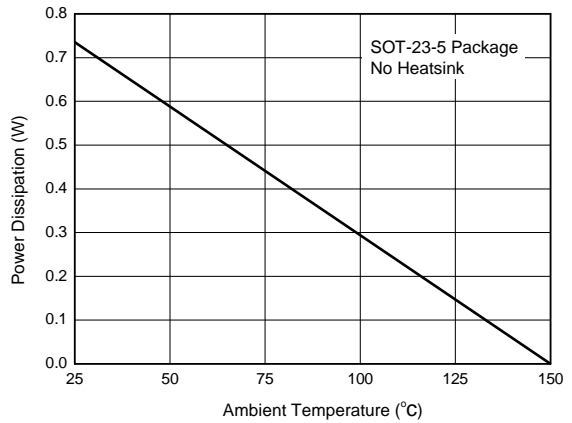

Figure 15. Power Dissipation vs. Ambient Temperature



**150mA RF ULDO REGULATOR WITH ERROR FLAG**

**AP2203**

**Typical Performance Characteristics (Continued)**

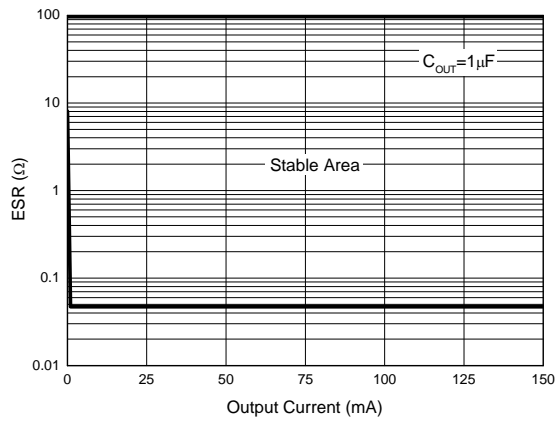

Figure 16. ESR vs. Output Current

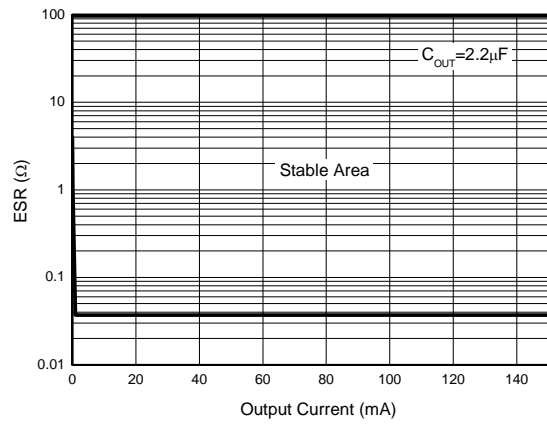

Figure 17. ESR vs. Output Current

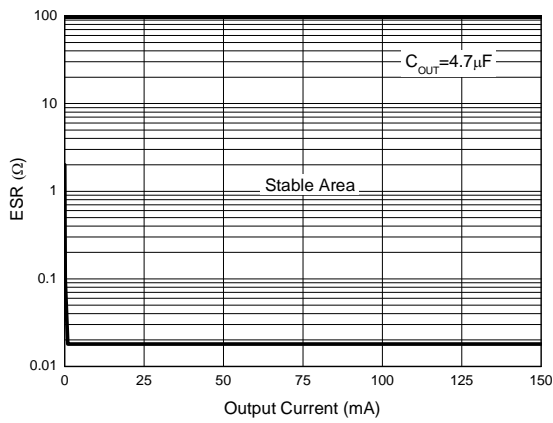

Figure 18. ESR vs. Output Current



**150mA RF ULDO REGULATOR WITH ERROR FLAG** **AP2203**

**Typical Application**

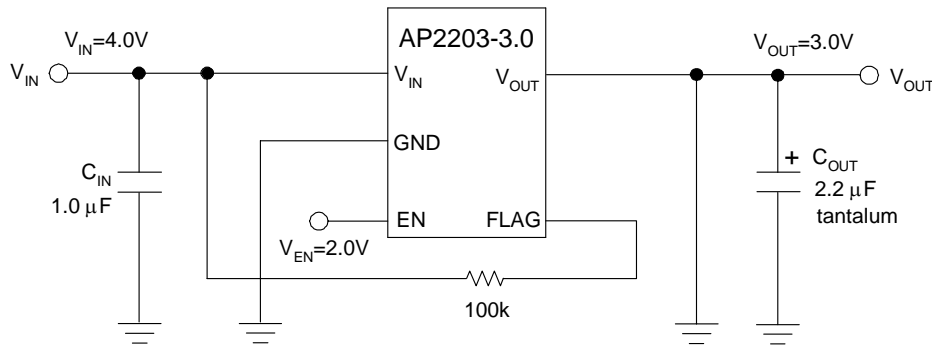

Figure 19. Typical Application of AP2203

Note 9: Dropout voltage is 165mV when  $T_A=25^{\circ}\text{C}$ . In order to obtain a normal output voltage,  $V_{\text{OUT}}+0.165\text{V}$  is the minimum input voltage which will result in a low PSRR, imposing a bad influence on system. Therefore, the recommended input voltage is  $V_{\text{OUT}}+0.5\text{V}$  to 13.2V. For AP2203-3.0V version, its input voltage can be set from 3.5V ( $V_{\text{OUT}}+0.5\text{V}$ ) to 13.2V.



**150mA RF ULDO REGULATOR WITH ERROR FLAG****AP2203****Application Information****Input Capacitor**

A 1 $\mu$ F minimum capacitor is recommended to be placed between  $V_{IN}$  and GND.

**Output Capacitor**

It is required to prevent oscillation. 1.0 $\mu$ F minimum is recommended. The output capacitor may be increased to improve transient response.

**Power Dissipation**

Thermal shutdown may take place if exceeding the maximum power dissipation in application. Under all possible operating conditions, the junction temperature must be within the range specified under absolute maximum ratings to avoid thermal shutdown.

To determine if the power dissipated in the regulator reaches the maximum power dissipation (see figure 15), using:

$$T_J = P_D * \theta_{JA} + T_A$$

$$P_D = (V_{IN} - V_{OUT}) * I_{OUT} + V_{IN} * I_{GND}$$

Where:  $T_J \leq T_{J(max)}$ .  $T_{J(max)}$  is absolute maximum ratings for the junction temperature;  $V_{IN} * I_{GND}$  can be ignored due to its small value.

$T_{J(max)}$  is 150 $^{\circ}$ C while  $\theta_{JA}$  is 200 $^{\circ}$ C/W, no heatsink is required since the package alone will dissipate enough heat to satisfy these requirements unless the calculated value for power dissipation exceeds the limit.

Take 3.0V version as an example:

$I_{OUT} = 150\text{mA}$ ,  $T_A = 50^{\circ}\text{C}$ ,  $V_{IN(Max)}$  is:

$$(150^{\circ}\text{C} - 50^{\circ}\text{C}) / (0.15\text{A} * 200^{\circ}\text{C/W}) + 3.0\text{V} = 6.333\text{V}$$

Therefore, for good performance, please make sure that input voltage is less than 6.333V without heatsink when  $T_A = 50^{\circ}\text{C}$ .



**150mA RF ULDO REGULATOR WITH ERROR FLAG**

**AP2203**

**Mechanical Dimensions**

**SOT-23-5**

**Unit: mm(inch)**

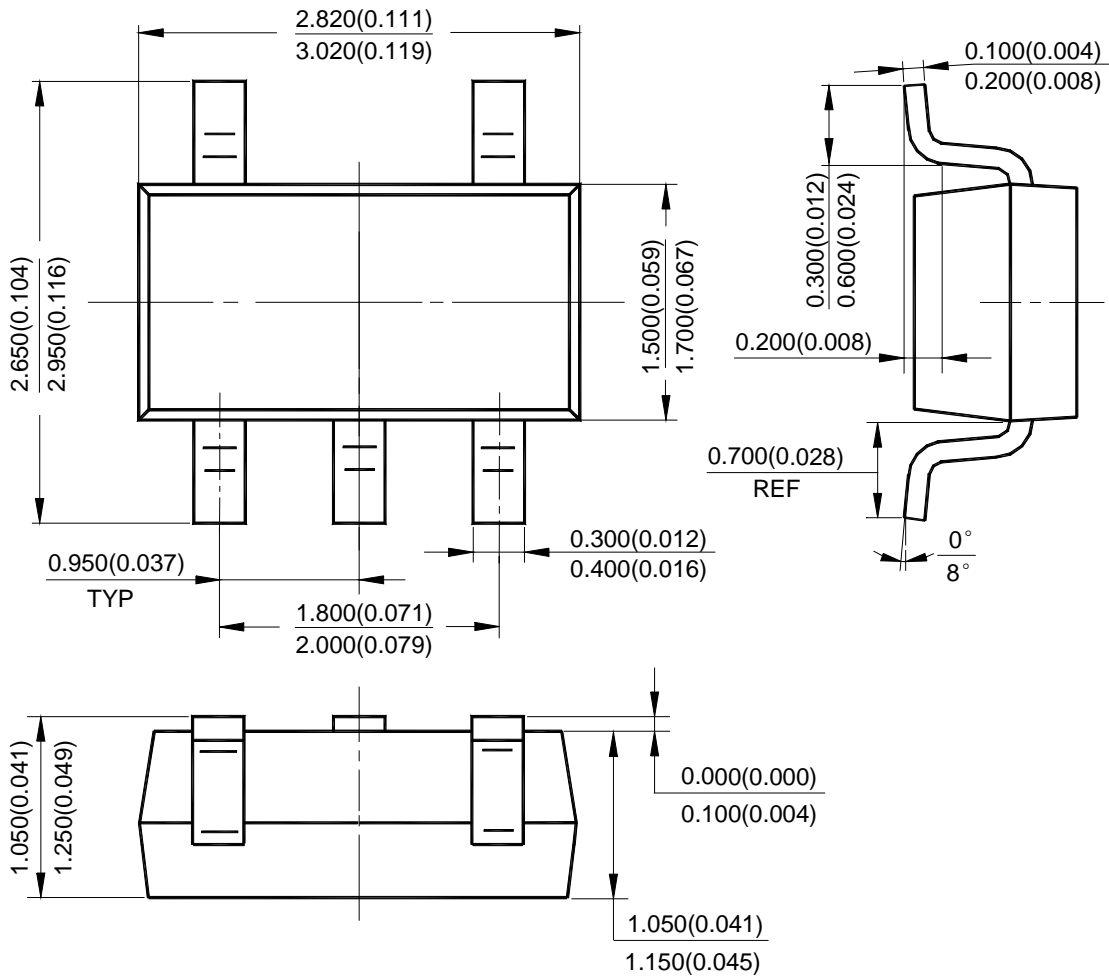



BCD Semiconductor Manufacturing Limited

<http://www.bcdsemi.com>

### IMPORTANT NOTICE

BCD Semiconductor Manufacturing Limited reserves the right to make changes without further notice to any products or specifications herein. BCD Semiconductor Manufacturing Limited does not assume any responsibility for use of any its products for any particular purpose, nor does BCD Semiconductor Manufacturing Limited assume any liability arising out of the application or use of any its products or circuits. BCD Semiconductor Manufacturing Limited does not convey any license under its patent rights or other rights nor the rights of others.

---

#### MAIN SITE

**BCD Semiconductor Manufacturing Limited**  
- Wafer Fab  
Shanghai SIM-BCD Semiconductor Manufacturing Limited  
800, Yi Shan Road, Shanghai 200233, China  
Tel: +86-21-6485 1491, Fax: +86-21-5450 0008

**BCD Semiconductor Manufacturing Limited**  
- IC Design Group  
Advanced Analog Circuits (Shanghai) Corporation  
8F, Zone B, 900, Yi Shan Road, Shanghai 200233, China  
Tel: +86-21-6495 9539, Fax: +86-21-6485 9673

#### REGIONAL SALES OFFICE

**Shenzhen Office**  
Shanghai SIM-BCD Semiconductor Manufacturing Co., Ltd. Shenzhen Office  
Advanced Analog Circuits (Shanghai) Corporation Shenzhen Office  
27B, Tower C, 2070, Middle Shen Nan Road, Shenzhen 518031, China  
Tel: +86-755-8368 3987, Fax: +86-755-8368 3166

**Taiwan Office**  
BCD Semiconductor (Taiwan) Company Limited  
4F, 298-1, Rui Guang Road, Nei-Hu District, Taipei,  
Taiwan  
Tel: +886-2-2656 2808, Fax: +886-2-2656 2806

**USA Office**  
BCD Semiconductor Corporation  
3170 De La Cruz Blvd., Suite 105, Santa Clara,  
CA 95054-2411, U.S.A  
Tel: +1-408-988 6388, Fax: +1-408-988 6386