

WHITE LED STEP-UP CONVERTER**AP3019A****General Description**

The AP3019A is an inductor-based DC/DC converter designed to drive up to eight white LEDs in series for backlight. Only one feedback resistor is needed to control the LED current and obtain required brightness.

A constant frequency 1.2MHz PWM control scheme is employed in this IC, which means tiny external components can be used. Specifically, 1mm tall inductor and 0.22 μ F output capacitor for a typical application is sufficient. Additionally, the Schottky diode in boost circuit is integrated on this chip. AP3019A also provides a disable pin to ease its use for different systems.

The output over-voltage protection is implemented in AP3019A. When any LED is broken or in other abnormal conditions, the output voltage will be clamped.

The AP3019A is available in standard SOT-23-6 and TSOT-23-6 packages.

Features

- Inherently Uniform LED Current
- High Efficiency up to 84%
- No Need for External Schottky Diode
- Output Over-voltage Protection (OVP)
- Fixed 1.2MHz Switching Frequency
- Uses Tiny 1mm Tall Inductor
- Requires Only 0.22 μ F Output Capacitor

Applications

- Cellular Phones
- Digital Cameras
- LCD modules
- GPS Receivers
- PDAs, Handheld Computers

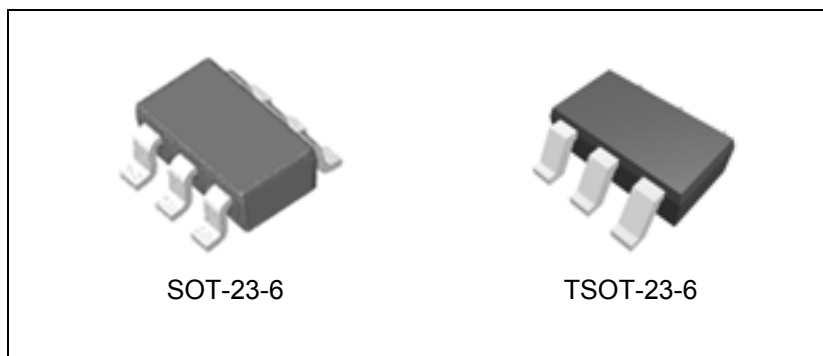

Figure 1. Package Types of AP3019A

WHITE LED STEP-UP CONVERTER
AP3019A
Pin Configuration

 K/KT Package
 (SOT-23-6/TSOT-23-6)

Figure 2. Pin Configuration of AP3019A (Top View)

Pin Description

Pin Number	Pin Name	Function
1	SW	Switch pin. Connect external inductor
2	GND	Ground
3	FB	Voltage feedback pin. Reference voltage is 200mV
4	CTRL	Shutdown and dimming pin. Connect to 1.8V or higher to enable device; Connect to 0.5V or less to disable device; Connect to a PWM signal to achieve LEDs brightness dimming
5	V_{OUT}	Output pin. Connect to the cathode of internal Schottky diode
6	V_{IN}	Input supply pin. Must be connected to a local bypass capacitor

WHITE LED STEP-UP CONVERTER

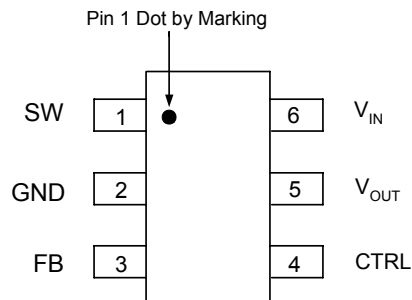
AP3019A

Functional Block Diagram

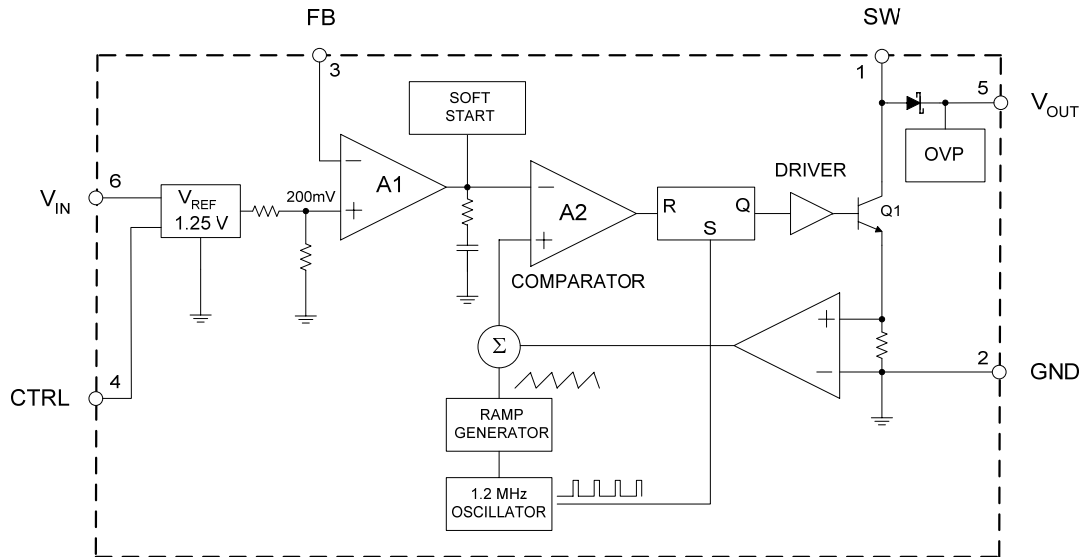
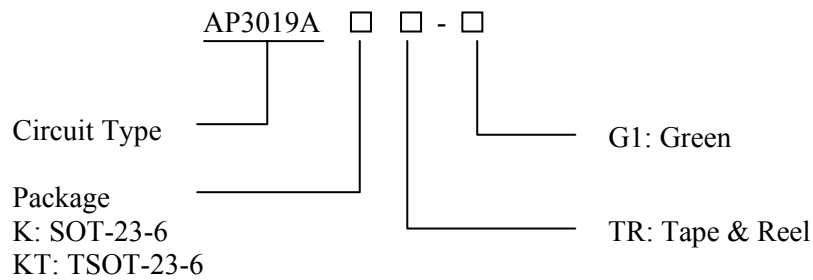

Figure 3. Functional Block Diagram of AP3019A

Ordering Information



Package	Temperature Range	Part Number	Marking ID	Packing Type
SOT-23-6	-40 to 85°C	AP3019AKTR-G1	GAS	Tape & Reel
TSOT-23-6	-40 to 85°C	AP3019AKTTR-G1	L8E	Tape & Reel

BCD Semiconductor's Pb-free products, as designated with "G1" suffix in the part number, are RoHS compliant and green.

**WHITE LED STEP-UP CONVERTER****AP3019A****Absolute Maximum Ratings (Note 1)**

Parameter	Symbol	Value	Unit
Input Voltage	V_{IN}	20	V
SW Pin Voltage	V_{SW}	38	V
Feedback Voltage	V_{FB}	20	V
CTRL Pin Voltage	V_{CTRL}	20	V
Thermal Resistance (Junction to Ambient, No Heat Sink)	θ_{JA}	265	°C/W
Operating Junction Temperature	T_J	150	°C
Storage Temperature Range	T_{STG}	-65 to 150	°C
Lead Temperature (Soldering, 10sec)	T_{LEAD}	260	°C
ESD (Machine Model)		250	V
ESD (Human Body Model)		2000	V

Note 1: Stresses greater than those listed under “Absolute Maximum Ratings” may cause permanent damage to the device. These are stress ratings only, and functional operation of the device at these or any other conditions beyond those indicated under “Recommended Operating Conditions” is not implied. Exposure to “Absolute Maximum Ratings” for extended periods may affect device reliability.

Recommended Operating Conditions

Parameter	Symbol	Min	Max	Unit
Operating Temperature Range	T_{OP}	-40	85	°C
Input Voltage	V_{IN}	2.5	16	V
CTRL Pin Voltage	V_{CTRL}		16	V

**WHITE LED STEP-UP CONVERTER****AP3019A****Electrical Characteristics** $V_{IN}=3V$, $V_{CTRL}=3V$, $T_A=25^{\circ}C$, unless otherwise specified.

Parameter	Symbol	Conditions	Min	Typ	Max	Unit
Minimum Operating Voltage	$V_{IN}(\min)$		2.5			V
Maximum Operating Voltage	$V_{IN}(\max)$				16	
Feedback Voltage (Note 2)	V_{FB}	$I_{OUT}=20mA$, 4 LEDs, $T_A=-40^{\circ}C$ to $85^{\circ}C$	188	200	212	mV
FB Pin Bias Current	I_{FB}			35	100	nA
Quiescent Current	I_Q	$V_{FB}=V_{IN}$, no switching	1.5	2.5	3.2	mA
Shutdown Quiescent Current	I_{SHDN}	$V_{CTRL}=0V$	2.0	4.0	6.0	μA
Switching Frequency	f		0.9	1.2	1.5	MHz
Maximum Duty Cycle	D_{MAX}		90	93		%
Switch Current Limit (Note 3)	I_{LIMIT}	D=40%		550		mA
		D=80%		550		
Switch V_{CE} Saturation Voltage	V_{CESAT}	$I_{SW}=250mA$		360		mV
Switch Leakage Current		$V_{SW}=5V$		0.01	5	μA
CTRL Pin Voltage	V_{CTRL}	High	1.8			V
		low			0.5	
CTRL Pin Bias Current	I_{CTRL}			100		μA
OVP Voltage	V_{OV}			30		V
Schottky Forward Drop	V_{DROP}	$I_D=150mA$		0.7		V
Schottky Leakage Current		$V_R(\text{reverse voltage})=23V$		0.1	4	μA
		$V_R(\text{reverse voltage})=27V$			150	
Soft Start Time	t			300		μS
Thermal Resistance (Junction to Case)	θ_{JC}	SOT-23-6		60		$^{\circ}C/W$
		TSOT-23-6		60		

Note 2: The bold type specifications of full temperature range are guaranteed by design (GBD).

Note 3: The switch current limit is related to duty cycle. Please refer to Figure 15 for detail.

WHITE LED STEP-UP CONVERTER

AP3019A

Typical Performance Characteristics

WLED forward voltage (V_F) is 3.45V at $I_F=20mA$, unless otherwise noted.

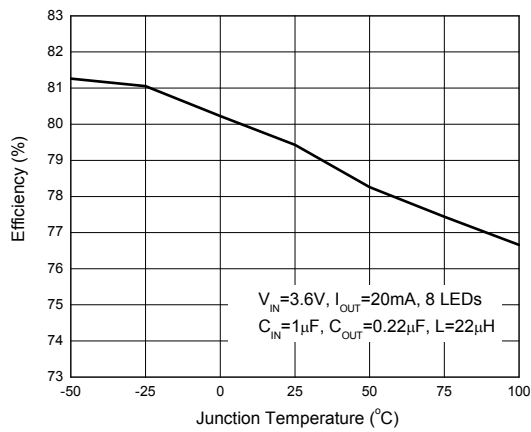

Figure 4. Efficiency vs. Junction Temperature

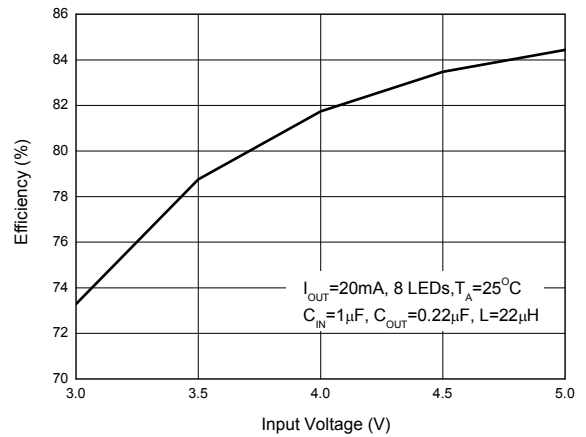

Figure 5. Efficiency vs. Input Voltage

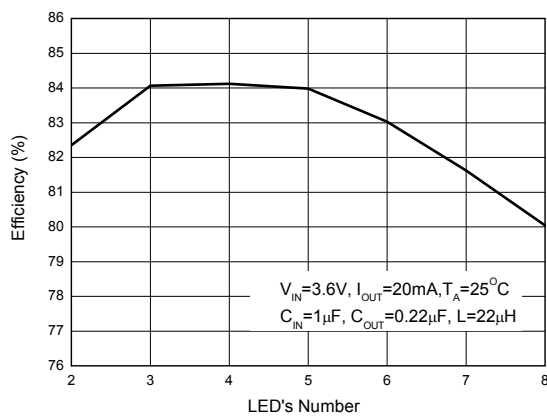

Figure 6. Efficiency vs. LED's Number

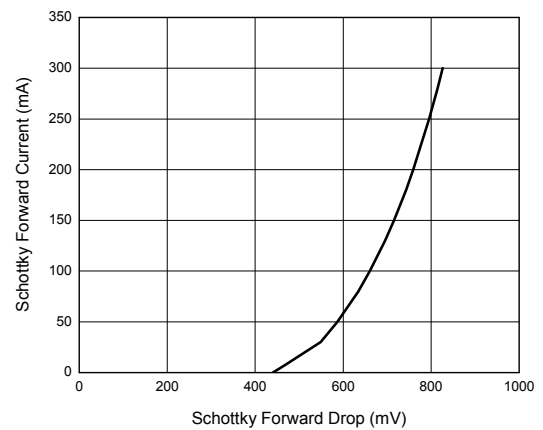

Figure 7. Schottky Forward Current vs. Schottky Forward Drop

WHITE LED STEP-UP CONVERTER

AP3019A

Typical Performance Characteristics (Continued)

WLED forward voltage (V_F) is 3.45V at $I_F=20\text{mA}$, unless otherwise noted.

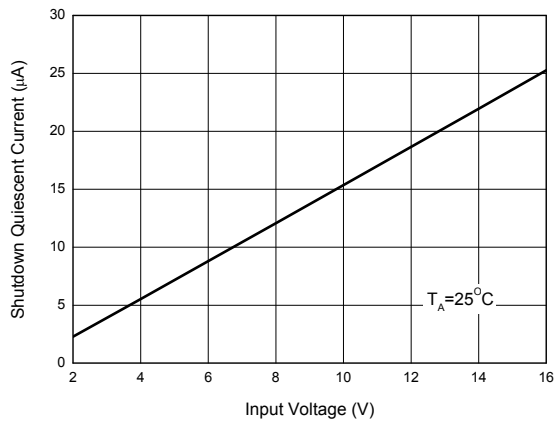

Figure 8. Shutdown Quiescent Current vs. Input Voltage

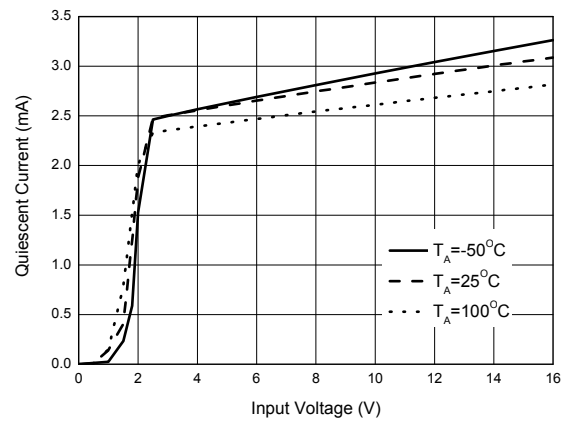

Figure 9. Quiescent Current vs. Input Voltage

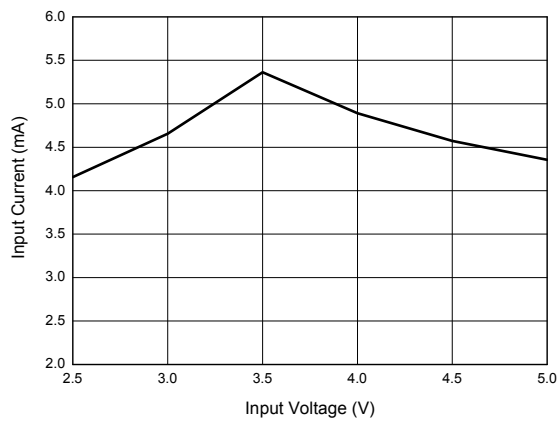

Figure 10. Input Current in Output Open Circuit vs. Input Voltage

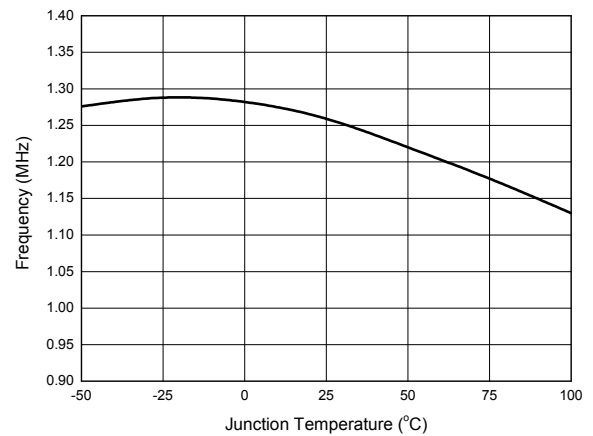

Figure 11. Frequency vs. Junction Temperature

WHITE LED STEP-UP CONVERTER

AP3019A

Typical Performance Characteristics (Continued)

WLED forward voltage (V_F) is 3.45V at $I_F=20mA$, unless otherwise noted.

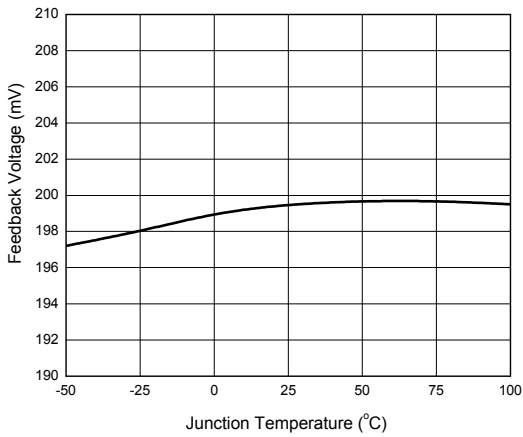

Figure 12. Feedback Voltage vs. Junction Temperature

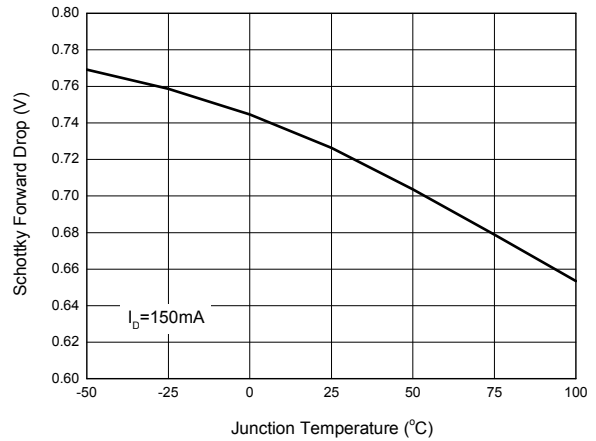

Figure 13. Schottky Forward Drop vs. Junction Temperature

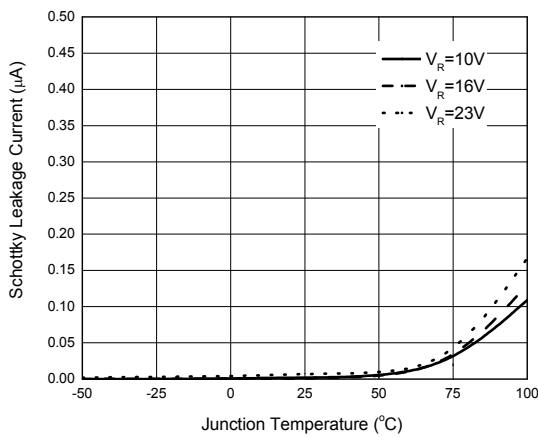

Figure 14. Schottky Leakage Current vs. Junction Temperature

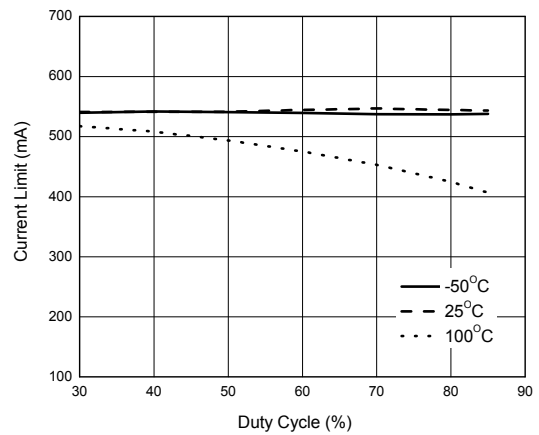

Figure 15. Current Limit vs. Duty Cycle

WHITE LED STEP-UP CONVERTER

AP3019A

Typical Performance Characteristics (Continued)

WLED forward voltage is 3.45V at $I_F=20\text{mA}$, unless otherwise noted.

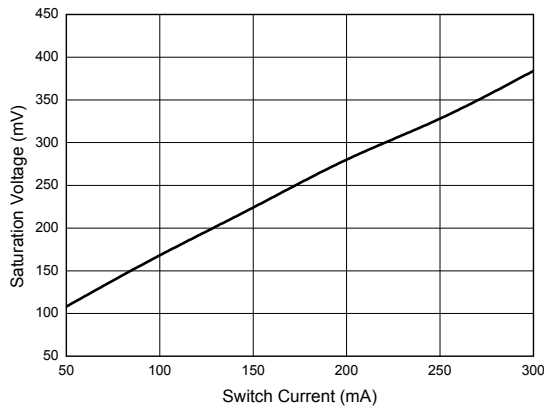

Figure 16. Saturation Voltage vs. Switch Current

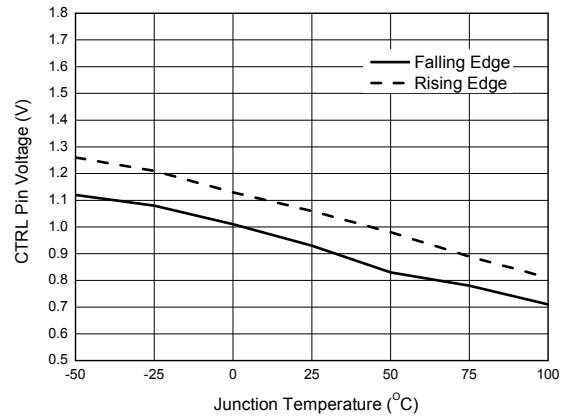

Figure 17. CTRL Pin Voltage vs. Junction Temperature

WHITE LED STEP-UP CONVERTER

AP3019A

Application Information

Operation

The AP3019A is a boost DC-DC converter which uses a constant frequency, current mode control scheme to provide excellent line and load regulation. Operation can be best understood by referring to the Figure 3.

At the start of each oscillator cycle, the SR latch is set and switch Q1 turns on. The switch current will increase linearly. The voltage on sense resistor is proportional to the switch current. The output of the current sense amplifier is added to a stabilizing ramp and the result is fed into the non-inversion input of the PWM comparator A2. When this voltage exceeds the output voltage level of the error amplifier A1, the SR latch is reset and the switch is turned off.

It is clear that the voltage level at inversion input of A2 sets the peak current level to keep the output in regulation. This voltage level is the output signal of error amplifier A1, and is the amplified signal of the voltage difference between feedback voltage and reference voltage of 200mV. So, a constant output current can be provided by this operation mode.

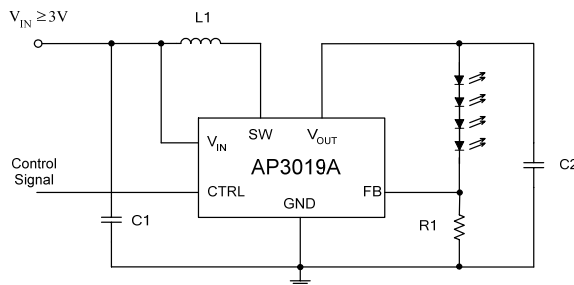

Figure 18. Typical Application Circuit to Decide R1

LED Current Control

Refer to Figure 18, the LED current is controlled by the feedback resistor R1. LEDs' current accuracy is determined by the regulator's feedback threshold accuracy and is independent of the LED's forward voltage variation. So the precise resistors are preferred. The resistance of R1 is in inverse proportion to the LED current since the feedback reference is fixed at 200mV. The relation for R1 and LED current can be expressed as below:

$$R_1 = \frac{200\text{mV}}{I_{LED}}$$

Over Voltage Protection

The AP3019A has an internal open-circuit protection circuit. When the LEDs are disconnected from circuit or fail open, the output voltage is clamped. The AP3019A will switch at a low frequency, and minimize input current.

Soft Start

The AP3019A has an internal soft start circuit to limit the inrush current during startup. The time of startup is controlled by internal soft start capacitor. Please refer to Figure 19.

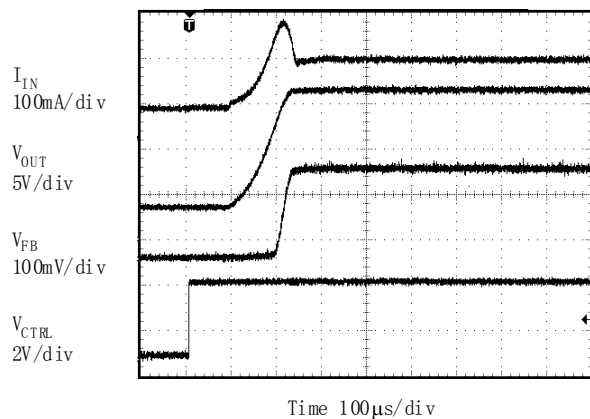

Figure 19. Soft Start Waveform
VIN=3.6V, 5 LEDs, ILED=20mA

Dimming Control

Two typical types of dimming control circuit are present as below. First, controlling CTRL Pin voltage to change operation state is a good choice. Second, changing the feedback voltage to get appropriate duty and luminous intensity is also useful.

(1) Adding a Control Signal to CTRL Pin

Adding a PWM Signal to CTRL pin directly. The AP3019A is turned on or off by the PWM signal when it is applied on the CTRL pin. The typical frequency of this PWM signal can be up to 2kHz. Please refer to Figure 20.

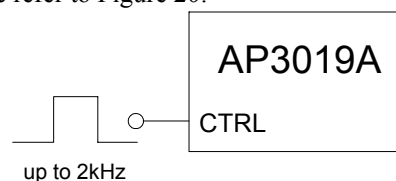

Figure 20. Dimming Control Using a PWM Signal in CTRL Pin

WHITE LED STEP-UP CONVERTER

AP3019A

Application Information (Continued)

(2) Changing the Effective Feedback Voltage
 There are three methods to change the effective feedback voltage.

First, adding a constant DC voltage through a resistor divider to FB pin can control the dimming. Changing the DC voltage or resistor between the FB Pin and the DC voltage can get appropriate luminous intensity. Comparing with all kinds of PWM signal control, this method features a stable output voltage and LEDs current. Please refer Figure 21.

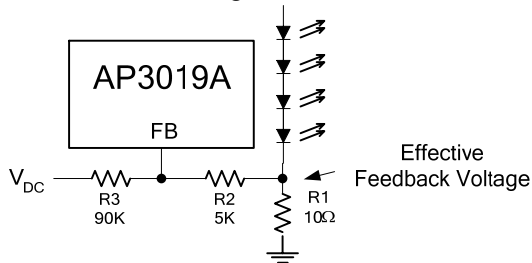

Figure 21. Dimming Control Using DC Voltage

Second, using a filtered PWM signal can do it. The filtered PWM signal can be considered as a varying and adjustable DC voltage.

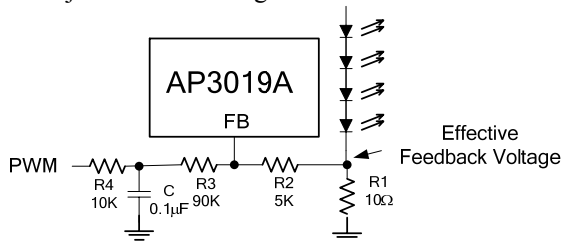

Figure 22. Dimming Control Using a Filtered PWM Voltage

Third, using a logic signal to change the feedback voltage. For example, the FB pin is connected to the GND through a MOSFET and a resistor. And this MOSFET is controlled a logic signal. The luminous intensity of LEDs will be changed when the MOSFET turns on or off.

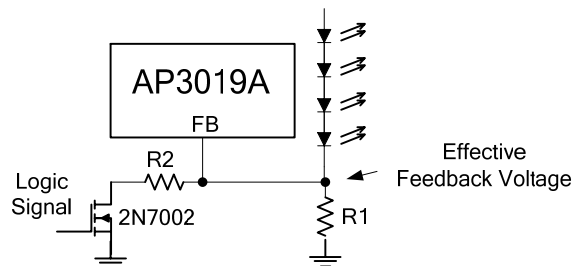
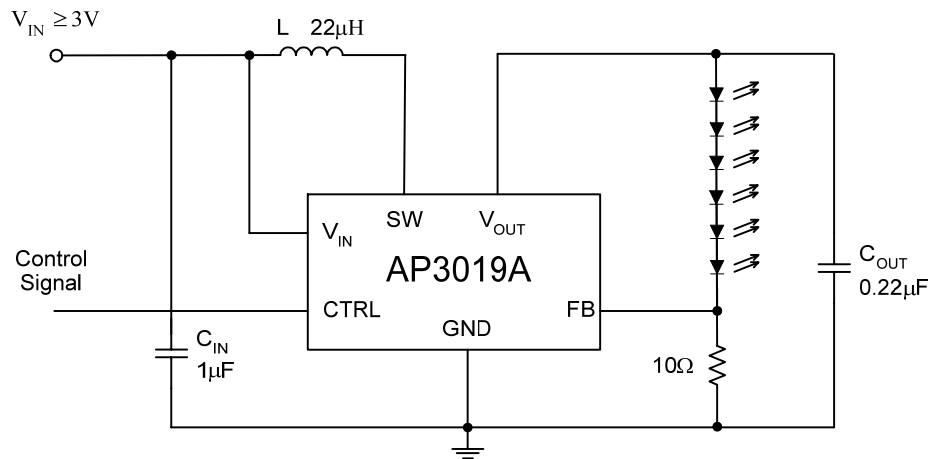

Figure 23. Dimming Control Using Logic Signal

WHITE LED STEP-UP CONVERTER
AP3019A
Typical Application

C: X5R or X7R dielectric

L: SUMIDA CDRH5D28R-220NC or equivalent

This circuit can work in full temperature

Figure 24. Typical Application of AP3019A

WHITE LED STEP-UP CONVERTER

AP3019A

Mechanical Dimensions

SOT-23-6

Unit: mm(inch)

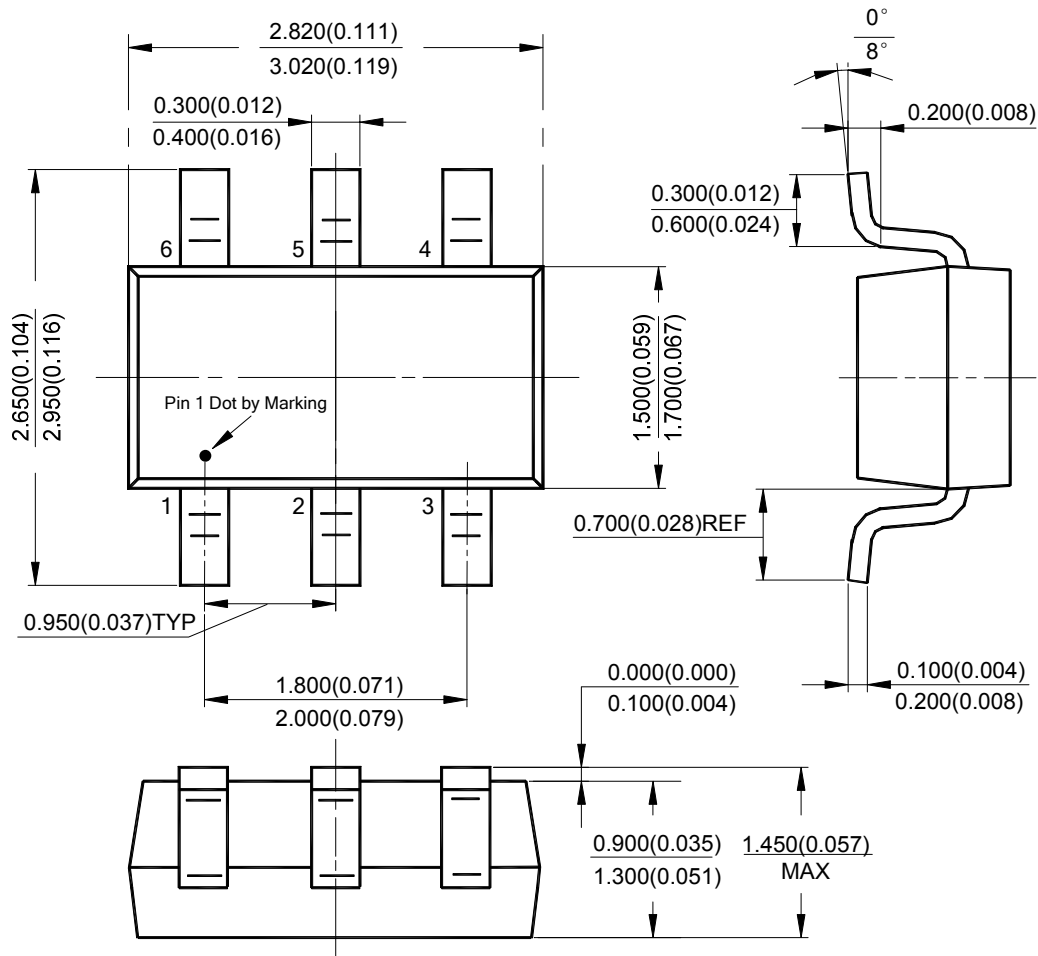

WHITE LED STEP-UP CONVERTER

AP3019A

Mechanical Dimensions (Continued)

TSOT-23-6

Unit: mm(inch)

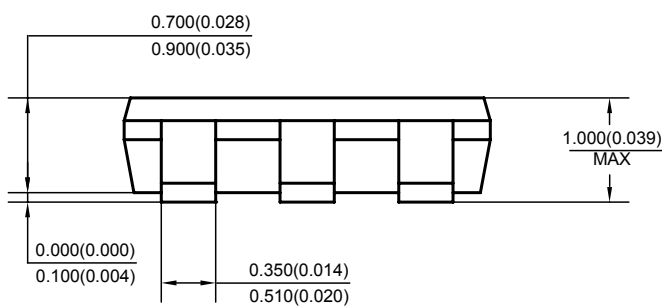
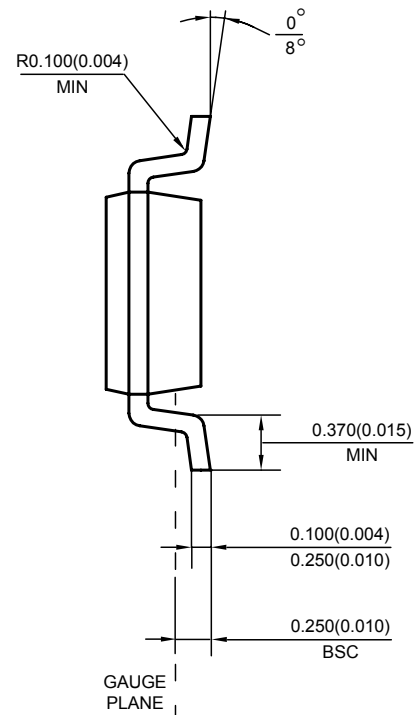
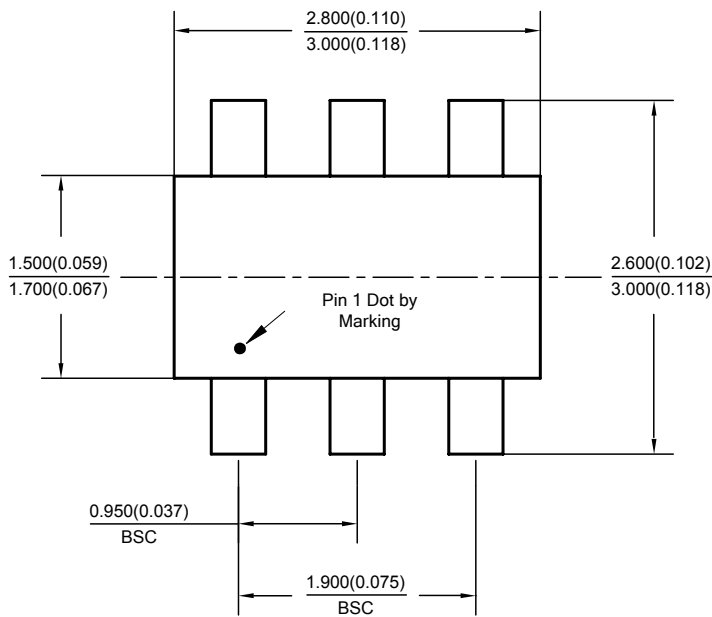



BCD Semiconductor Manufacturing Limited

<http://www.bcdsemi.com>

IMPORTANT NOTICE

BCD Semiconductor Manufacturing Limited reserves the right to make changes without further notice to any products or specifications herein. BCD Semiconductor Manufacturing Limited does not assume any responsibility for use of any its products for any particular purpose, nor does BCD Semiconductor Manufacturing Limited assume any liability arising out of the application or use of any its products or circuits. BCD Semiconductor Manufacturing Limited does not convey any license under its patent rights or other rights nor the rights of others.

MAIN SITE

- Headquarters

BCD Semiconductor Manufacturing Limited

No. 1600, Zi Xing Road, Shanghai Zizhu Science-based Industrial Park, 200241, China
Tel: +86-21-24162266, Fax: +86-21-24162277

- Wafer Fab

Shanghai SIM-BCD Semiconductor Manufacturing Co., Ltd.

800 Yi Shan Road, Shanghai 200233, China
Tel: +86-21-6485 1491, Fax: +86-21-5450 0008

REGIONAL SALES OFFICE

Shenzhen Office

Shanghai SIM-BCD Semiconductor Manufacturing Co., Ltd., Shenzhen Office

Unit A Room 1203, Skyworth Bldg., Gaoxin Ave. 1.S., Nanshan District, Shenzhen, China
Tel: +86-755-8826 7951
Fax: +86-755-8826 7865

Taiwan Office

BCD Semiconductor (Taiwan) Company Limited

4F, 298-1, Rui Guang Road, Nei-Hu District, Taipei, Taiwan
Tel: +886-2-2656 2808
Fax: +886-2-2656 2806

USA Office

BCD Semiconductor Corp.

30920 Huntwood Ave. Hayward, CA 94544, USA
Tel : +1-510-324-2988
Fax: +1-510-324-2788