

Description

The AR0521D5 is a bi-directional TVS diode, utilizing leading monolithic silicon technology to provide fast response time and low ESD clamping voltage, making this device an ideal solution for protecting voltage sensitive high-speed data lines. The AR0521D5 has an ultra-low capacitance with a typical value at 0.3pF, and complies with the IEC 61000-4-2 (ESD) with ± 25 kV air and ± 22 kV contact discharge. It is assembled into a SOD-523 lead-free package. The small size, ultra-low capacitance and high ESD surge protection make AR0521D5 an ideal choice to protect cell phone, digital visual interfaces and other high speed ports.

Features

- Ultra low capacitance: 0.3pF typical
- Ultra low leakage: nA level
- Operating voltage: 5V
- Low clamping voltage
- Complies with following standards:
 - IEC 61000-4-2 (ESD) immunity test
 - Air discharge: ± 25 kV
 - Contact discharge: ± 22 kV
 - IEC61000-4-5 (Lightning) 4A (8/20 μ s)
- RoHS Compliant

Dimensions and Pin Configuration

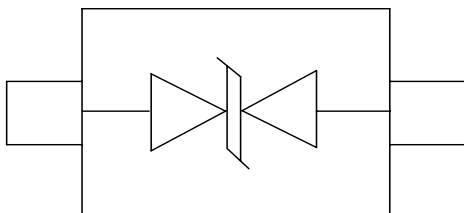

Circuit and Pin Schematic

Mechanical Characteristics

- Package: SOD-523
- Lead Finish: Matte Tin
- Case Material: "Green" Molding Compound.
- Moisture Sensitivity: Level 3 per J-STD-020
- Terminal Connections: See Diagram Below
- Marking Information: See Below

Applications

- Cellular Handsets and Accessories
- Display Ports
- MDDI Ports
- USB Ports
- Digital Visual Interface (DVI)
- PCI Express and Serial SATA Ports

Marking Information

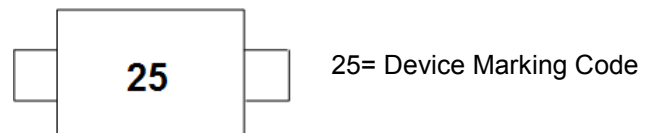

Ordering Information

Part Number	Packaging	Reel Size
AR0521D5	3000/Tape & Reel	7 inch

Absolute Maximum Ratings ($T_A=25^{\circ}\text{C}$ unless otherwise specified)

Parameter	Symbol	Value	Unit
Peak Pulse Power (8/20 μs)	Ppk	100	W
Peak Pulse Current (8/20 μs)	I _{PP}	4	A
ESD per IEC 61000-4-2 (Air)	V _{ESD}	± 25	kV
ESD per IEC 61000-4-2 (Contact)		± 22	
Operating Temperature Range	T _J	-55 to +125	$^{\circ}\text{C}$
Storage Temperature Range	T _{stg}	-55 to +150	$^{\circ}\text{C}$

Electrical Characteristics ($T_A=25^{\circ}\text{C}$ unless otherwise specified)

Parameter	Symbol	Min	Typ	Max	Unit	Test Condition
Reverse Working Voltage	V _{RWM}			5	V	
Breakdown Voltage	V _{BR}	6.5		9.5	V	I _T = 1mA
Reverse Leakage Current	I _R		0.02	0.2	μA	V _{RWM} = 5V
Clamping Voltage	V _C			12	V	I _{PP} = 1A (8 x 20 μs pulse)
Clamping Voltage	V _C			25	V	I _{PP} = 4A (8 x 20 μs pulse)
Junction Capacitance	C _J		0.3	0.5	pF	V _R = 0V, f = 1MHz

Typical Performance Characteristics (TA=25°C unless otherwise Specified)

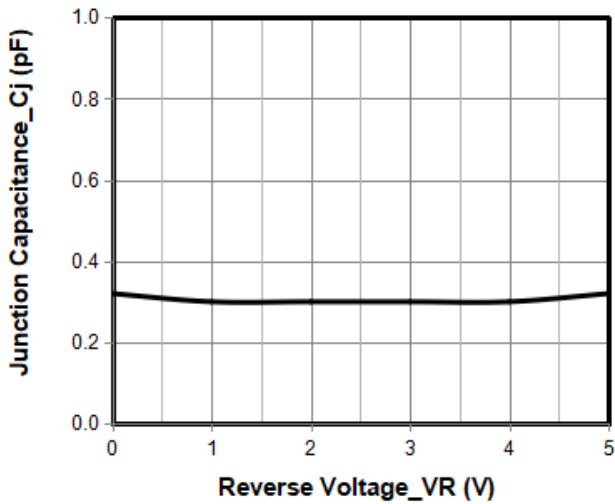

Junction Capacitance vs. Reverse Voltage

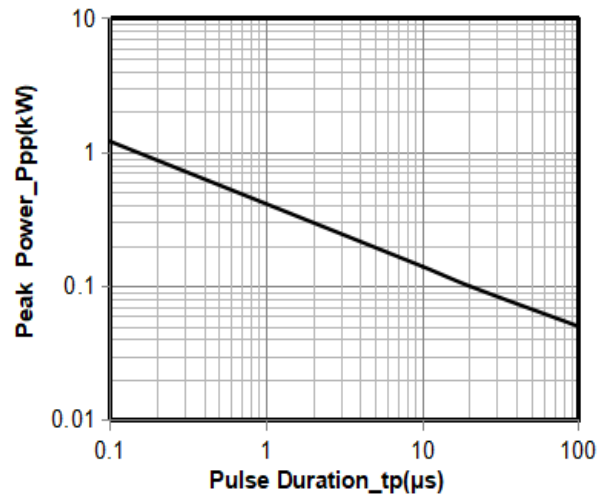

Peak Pulse Power vs. Pulse Time

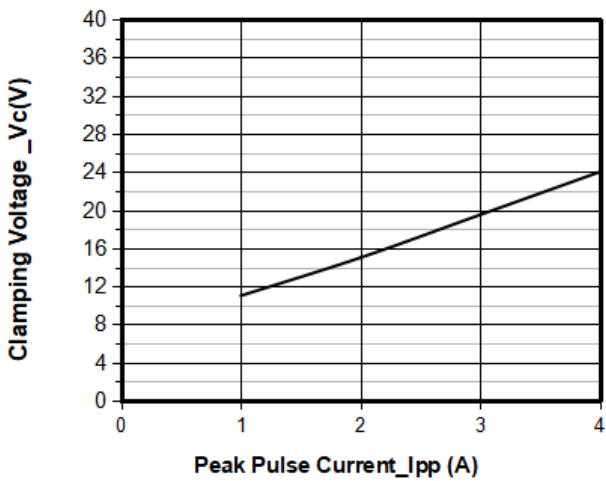

Clamping Voltage vs. Peak Pulse Current

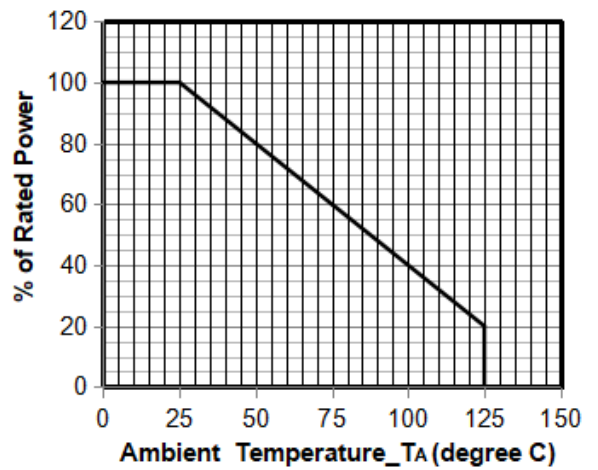

Power Derating Curve

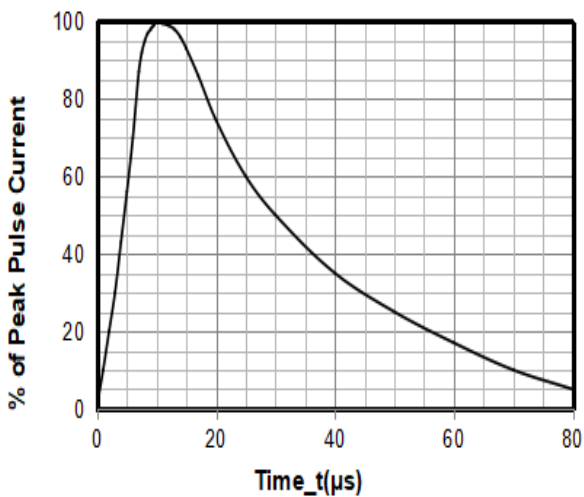

8 X 20μs Pulse Waveform

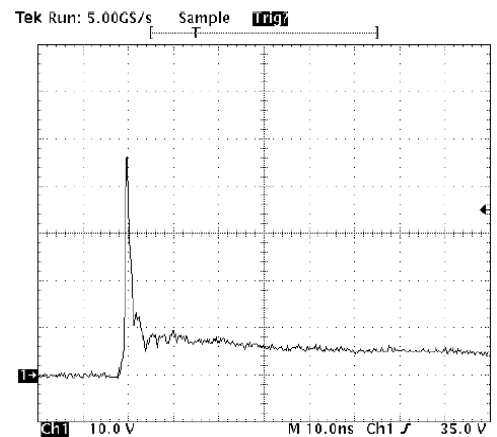

Note: Data is taken with a 10x attenuator

ESD Clamping Voltage

8 kV Contact per IEC61000-4-2

SOD-523 Package Outline Drawing

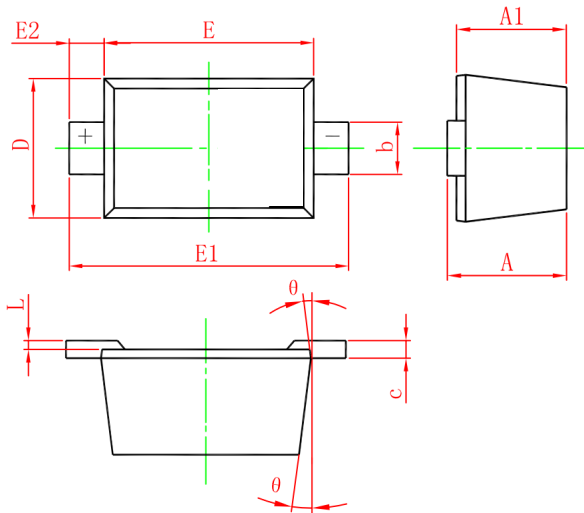

SYM	DIMENSIONS					
	MILLIMETERS			INCHES		
	MIN	NOM	MAX	MIN	NOM	MAX
A	0.51	--	0.77	0.020	--	0.031
A1	0.50	--	0.70	0.020	--	0.028
b	0.25	--	0.35	0.010	--	0.014
c	0.08	--	0.15	0.003	--	0.006
D	0.75	--	0.85	0.030	--	0.033
E	1.10	--	1.30	0.043	--	0.051
E1	1.50	--	1.70	0.059		0.067
E2	0.20REF			0.008REF		
L	0.01	--	0.07	0.001	--	0.003
Θ	7° REF			7° REF		

Suggested Land Pattern

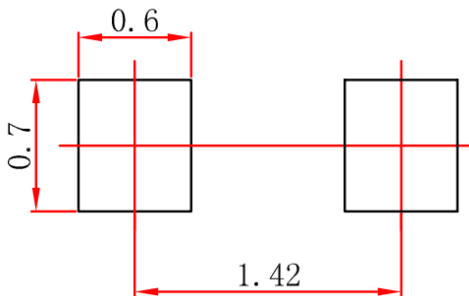

Unit: mm

Contact Information

Applied Power Microelectronics Co., Ltd.

Website: <http://www.appliedpowermicro.com>

Email: sales@appliedpowermicro.com

Phone: +86 (0519) 8399 3606