

**ANSALDO****Ansaldo Trasporti s.p.a.  
Unita' Semiconduttori**Via N. Lorenzi 8 - I 16152 GENOVA - ITALY  
Tel. int. +39/(0)10 6556549 - (0)10 6556488  
Fax Int. +39/(0)10 6442510  
Tx 270318 ANSUSE I -**FAST RECOVERY DIODE****ARF678**

Repetitive voltage up to	<b>4500 V</b>
Mean forward current	<b>1690 A</b>
Surge current	<b>27 kA</b>

**FINAL SPECIFICATION**

apr 97 - ISSUE : 01

Symbol	Characteristic	Conditions	T <sub>j</sub> [°C]	Value	Unit
<b>BLOCKING</b>					
V <sub>RRM</sub>	Repetitive peak reverse voltage		150	4500	V
V <sub>RSM</sub>	Non-repetitive peak reverse voltage		150	4600	V
I <sub>RRM</sub>	Repetitive peak reverse current	V=VRRM	150	150	mA
<b>CONDUCTING</b>					
I <sub>F(AV)</sub>	Mean forward current	180° sin ,50 Hz, Th=55°C, double side cooled		1690	A
I <sub>F(AV)</sub>	Mean forward current	180° square,50 Hz,Th=55°C,double side cooled		1735	A
I <sub>FSM</sub>	Surge forward current	Sine wave, 10 ms reapplied reverse voltage up to 50% VRSM	150	27	kA
I <sup>2</sup> t	I <sup>2</sup> t			2880 x1E3	A <sup>2</sup> s
V <sub>FM</sub>	Forward voltage	Forward current : 2000 A	25	2.40	V
V <sub>F(TO)</sub>	Threshold voltage		150	1.30	V
r <sub>F</sub>	Forward slope resistance		150	0.650	mohm
<b>SWITCHING</b>					
t <sub>rr</sub>	Reverse recovery time	I <sub>F</sub> = 1000 A di/dt= 250 A/μs VR = 50 V	150	4.2	μs
Q <sub>rr</sub>	Reverse recovery charge			1350	μC
I <sub>rr</sub>	Peak reverse recovery current			650	A
s	Softness (s-factor), min			0.5	
V <sub>FR</sub>	Peak forward recovery	di/dt= 400 A/μs	150	40	V
<b>MOUNTING</b>					
R <sub>th(j-h)</sub>	Thermal impedance	Junction to heatsink, double side cooled		14.0	°C/kW
T <sub>j</sub>	Operating junction temperature			-30 / 150	°C
F	Mounting force			35.0 / 40.0	kN
	Mass			850	g
<b>ORDERING INFORMATION : ARF678 S 45</b>					
standard specification <input type="checkbox"/> <input type="checkbox"/> VRRM/100					

DISSIPATION CHARACTERISTICS

SQUARE WAVE

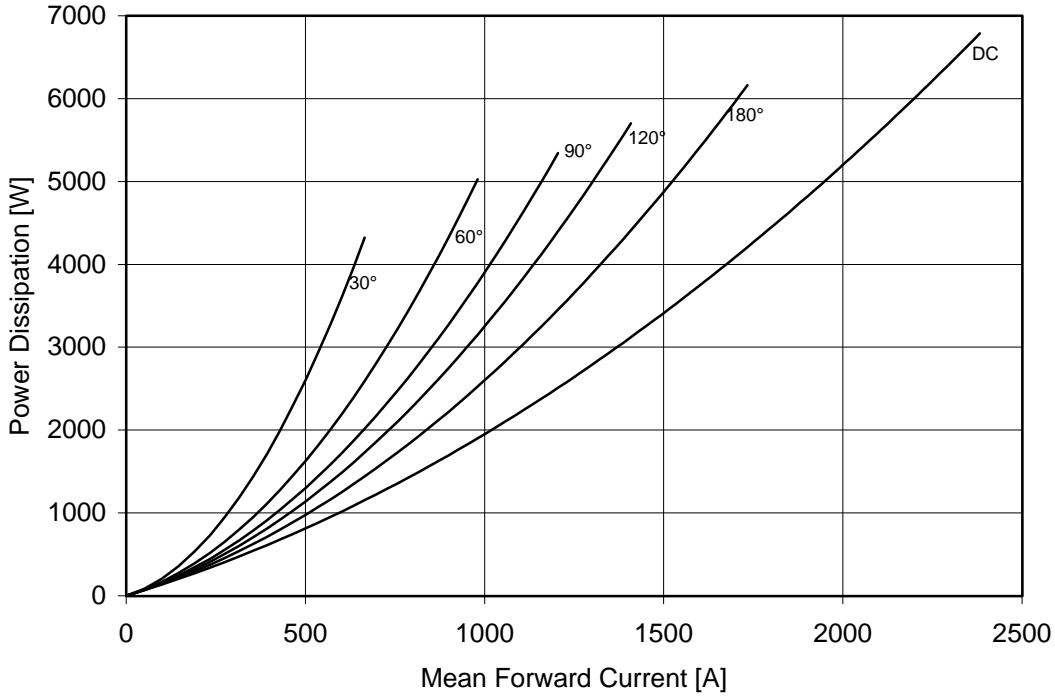

SINE WAVE

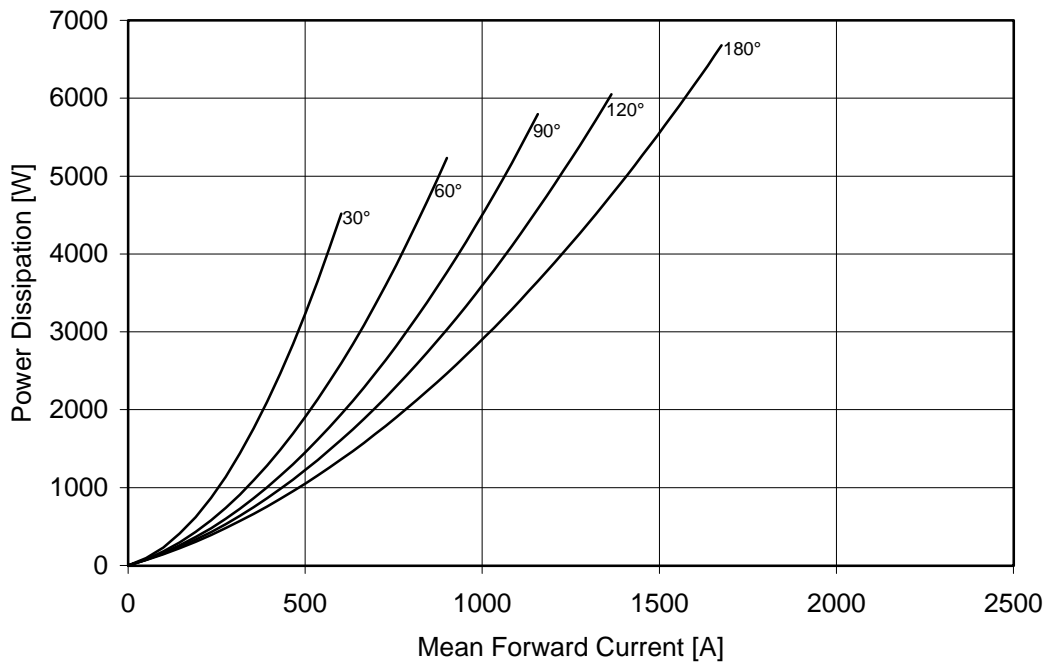

## SWITCHING CHARACTERISTICS

FORWARD RECOVERY VOLTAGE

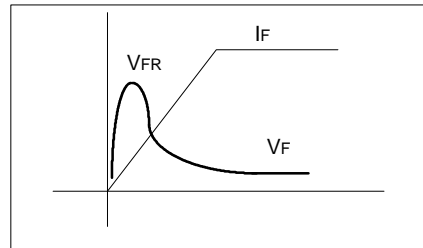
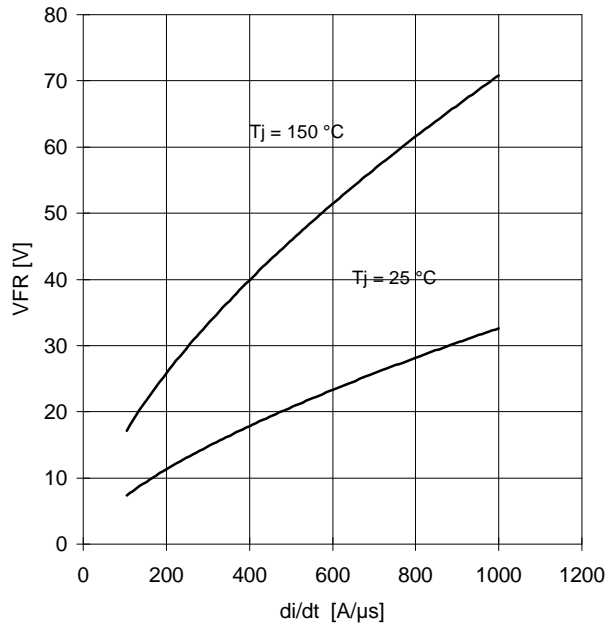

REVERSE RECOVERY CHARGE  
Tj=150°C

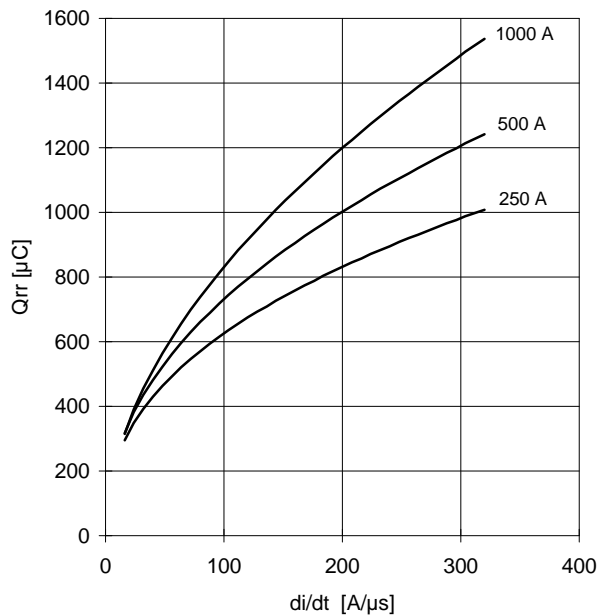

REVERSE RECOVERY CURRENT  
Tj=150°C

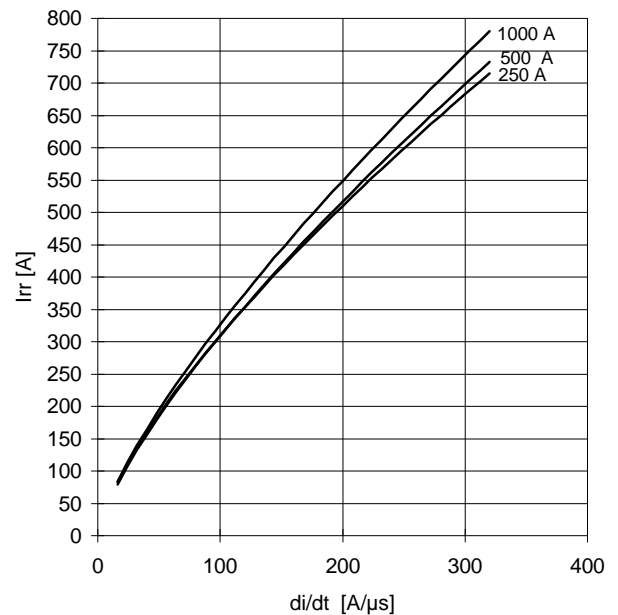

$$t_a = I_{rr} / (di/dt) \quad t_b = t_{rr} - t_a$$

$$\text{Softness (s factor)} \quad s = t_b / t_a$$

$$\text{Energy dissipation during recovery} \quad E_r = V_r \cdot (Q_{rr} - I_{rr} \cdot t_a / 2)$$

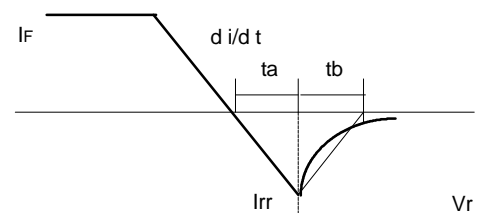

FORWARD CHARACTERISTIC  
T<sub>j</sub> = 150 °C

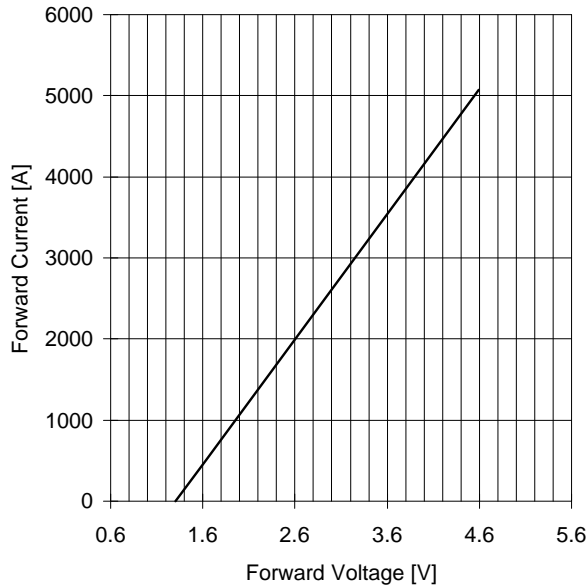

SURGE CHARACTERISTIC  
T<sub>j</sub> = 150 °C

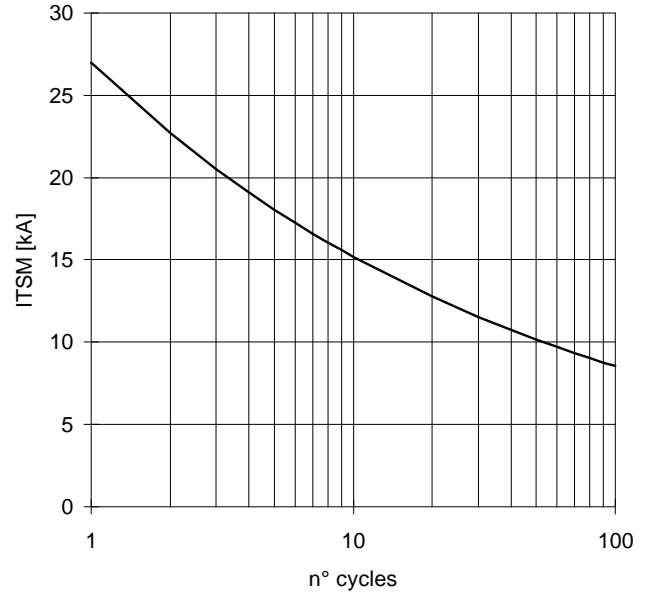

TRANSIENT THERMAL IMPEDANCE  
DOUBLE SIDE COOLED

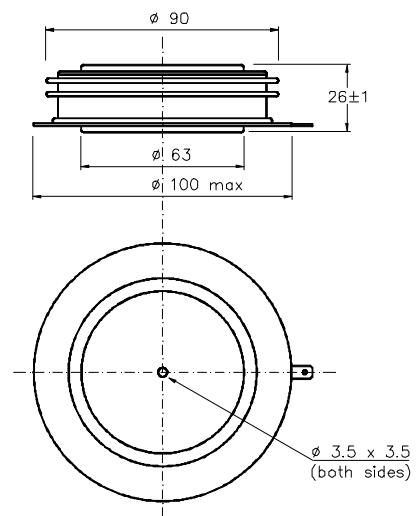
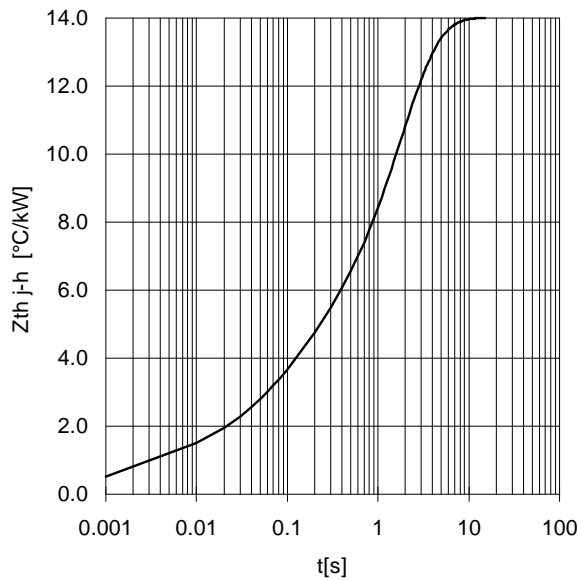

Dimensions in mm



All the characteristics given in this data sheet are guaranteed only with uniform clamping force, cleaned and lubricated heatsink, surfaces with flatness < .03 mm and roughness < 2 μm.

In the interest of product improvement ANSALDO reserves the right to change any data given in this data sheet at any time without previous notice.

If not stated otherwise the maximum value of ratings (symbols over shaded background) and characteristics is reported.

Distributed by

