

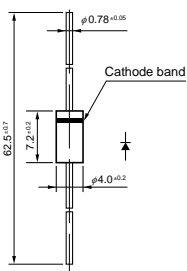

• No. 13 Axial ( $\phi 4.0/\phi 0.78$ )

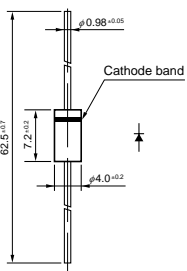

• No. 14 Axial ( $\phi 4.0/\phi 0.98$ )



• No. 15 Axial ( $\phi 6.5/\phi 1.4$ )

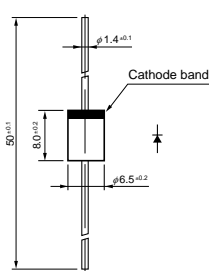

• No. 16 TO-220F (Two Elements)

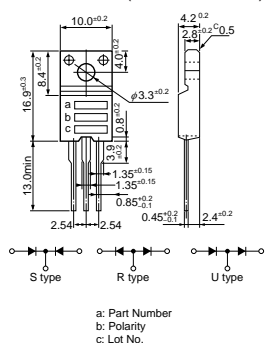

• No. 17 TO-220F (Center-tap)

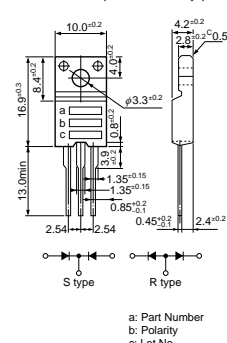

• No. 18 TO-220F2Pin

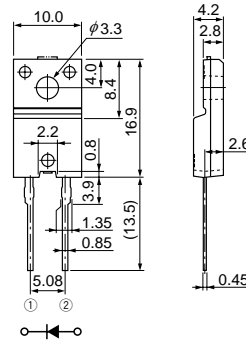

• No. 19 TO-220F2Pin (Two Elements)

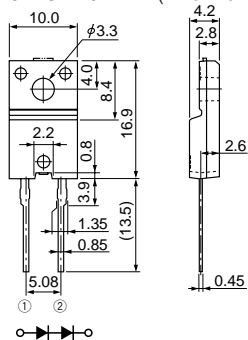

• No. 20 TO-3PF

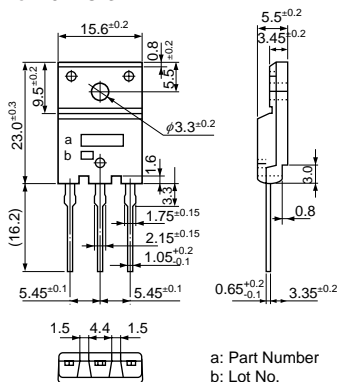

• No. 21 TO-3PF2Pin

