

4-channel H-bridge type BTL driver for CD players

BA6299FP

The BA6299FP is a 4-channel H-bridge BTL driver for CD player motors and actuators. The 5V regulator and internal standard operational amplifier make this IC suited to a broad range of applications.

●Applications

CD players and CD-ROM drives

●Features

- 1) HSOP 28-pin package allows for miniaturization of applications.
- 2) Wide dynamic range.
- 3) Low number of external components.
- 4) Driver gain is adjustable with a single attached resistor.
- 5) Internal 5V regulator. (requires attached PNP transistor)
- 6) Internal standard operational amplifier.
- 7) Internal thermal shutdown circuit.

●Block diagram

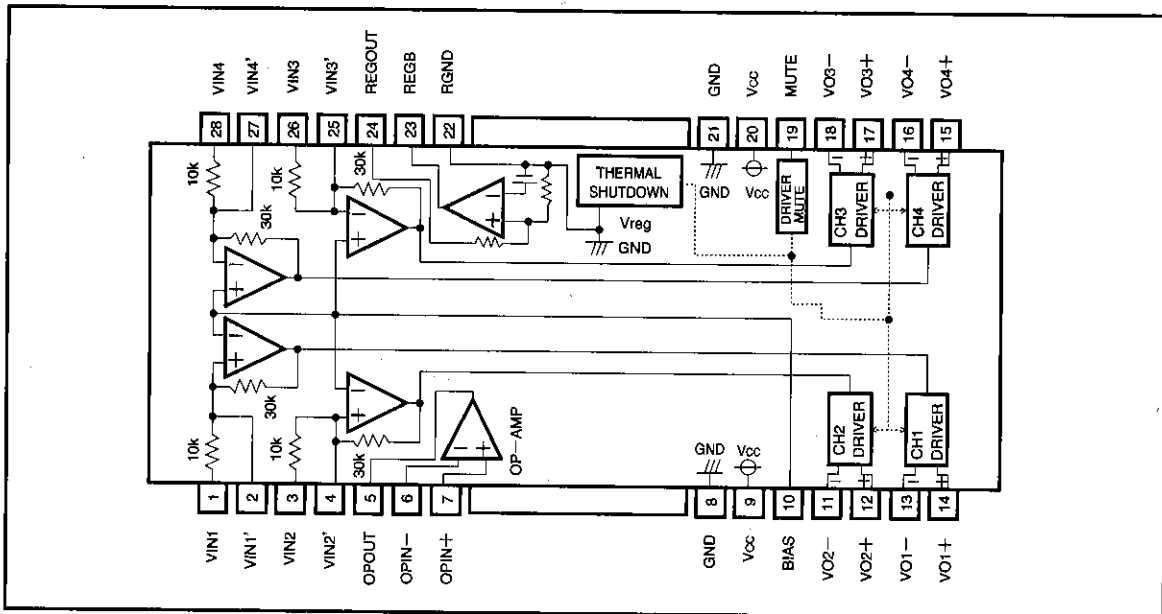

●Pin description

Pin No.	Pin name	Function
1	VIN1	Driver channel 1 input
2	VIN1'	Input for changing driver channel 1 gain
3	VIN2	Driver channel 2 input
4	VIN2'	Input for changing driver channel 2 gain
5	OPOUT	Operational amplifier output
6	OPIN—	Operational amplifier negative input
7	OPIN+	Operational amplifier positive input
8	GND	Substrate ground
9	V _{cc}	Power supply
10	BIAS	Bias input
11	VO2—	Driver channel 2 negative output
12	VO2+	Driver channel 2 positive output
13	VO1—	Driver channel 1 negative output
14	VO1+	Driver channel 1 positive output
15	VO4+	Driver channel 4 positive output
16	VO4—	Driver channel 4 negative output
17	VO3+	Driver channel 3 positive output
18	VO3—	Driver channel 3 negative output
19	MUTE	Mute control
20	V _{cc}	Power supply
21	GND	Substrate ground
22	RGND	Regulator ground
23	REGB	Connect to base of attached transistor
24	REGOUT	5 V output (connect to base of attached transistor collector)
25	VIN3'	Input for changing driver channel 3 gain
26	VIN3	Driver channel 3 input
27	VIN4'	Input for changing driver channel 4 gain
28	VIN4	Driver channel 4 input

Note) Positive output' and 'negative output' indicate the phase relative to input.

CD/CD-ROM Drivers (4 channels)

For CDs/CD-ROMs

●Input/output circuit

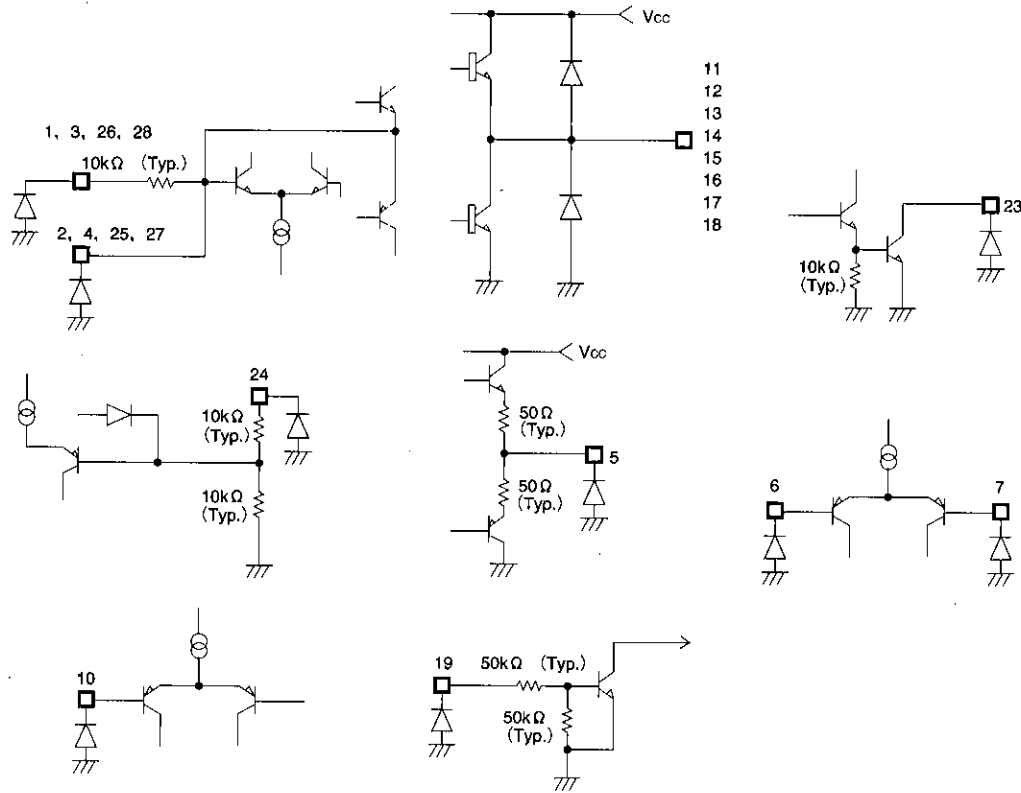

Fig. 1

●Absolute maximum values (Ta=25°C)

Parameter	Symbol	Limits	Unit
Power supply voltage	Vcc	18	V
Power dissipation	Pd	1.7*1	W
Operating temperature	Topr	-30~85	°C
Storage temperature	Tstg	-55~150	°C

*1 When mounted on 50 × 50 × 1.0 mm phenol paper PCB.
Reduced by 13.6 mW for each increase in Ta of 1°C over 25°C.

●Recommended operating conditions (Ta=25°C)

Parameter	Symbol	Limits	Unit
Power supply voltage	Vcc	6~11*2	V

*2 4 - 11 V when regulator not used

●Electrical characteristics (Unless otherwise noted, Ta=25°C, Vcc=8V, RL=8Ω)

Parameter	Symbol	Min.	Typ.	Max.	Unit	Conditions
(Driver)						
Quiescent current	I _o	2.5	5.0	7.5	mA	No load
Input offset voltage	V _{DI}	-5	0	5	mV	
Output offset voltage	V _{DO}	-5	0	5	mV	
Dead zone width	V _{DB}	10	20	30	mV	(Total for positive and negative)
Maximum output amplitude	V _{OM}	5.6	6.0	-	V	Differential output
Voltage gain	G _{VC}	7.0	9.5	11.5	dB	V _{in} = 500 mV DC, differential output
Positive and negative voltage differential gain	ΔG _{VC}	-0.9	0	0.9	dB	V _{in} = 500 mV DC, differential output
Ripple rejection	RR	-	80	-	dB	V _{in} =0.1Vrms, 100Hz
Mute-off voltage	V _{MOFF}	2.0	-	-	V	
Mute-on voltage	V _{MON}	-	-	0.5	V	
(5 V regulator)						
Output voltage	V _{REG}	4.75	5.00	5.25	V	I _L =100mA
Output load variation	ΔV _{RL}	-50	0	10	mV	I _L =0~200mA
Input variation	ΔV _{VCC}	-10	0	40	mV	(V _{CC} 666=6~11V) I _L =100mA
Drop voltage	V _{DI}	-	0.3	0.6	V	V _{CC} =4.7V, I _L =200mA *1
Vreg amplifier output current	I _{REG}	8	20	-	mA	V _{CC} =4.7V, When 3V is added *2
(Operational amplifier)						
Offset voltage	V _{OPOP}	-5	0	5	mV	
Input bias current	I _{BOP}	-	-	300	nA	
High-level output voltage	V _{DHOP}	6.5	7.2	-	V	
Low-level output voltage	V _{DLOP}	-	-	1.8	V	
Output drive current (sink)	I _{SINK}	10	40	-	mA	50Ω at V _{CC}
Output drive current (source)	I _{SOURCE}	10	40	-	mA	50Ω at GND
Open loop voltage gain	G _{VO}	-	72	-	dB	V _{in} =-75dBV, 1kHz
Slew rate	SR	-	1	-	V/μs	

*1 Under conditions in which the power transistor satisfies the characteristic V_{sat} < 0.2 V when I_o = 200 mA.

*2 Pin 24= open

●Circuit operation

1. Driver

Inputs to the IC are the focus tracking error signal from the servo preamplifier and the control signal from the motor. The input signals normally center on 2.5V. Polarity is switched when a signal is greater or less than the bias voltage. When polarity is switched, power

transistors Q1 and Q4 or Q2 and Q3 turn on. Power transistor Q1 or Q3, whichever is turned on, is driven by the full wave rectified signal and the level shifted signal, and supplies current to the load. When there is no input, both output pins are at the GND level.

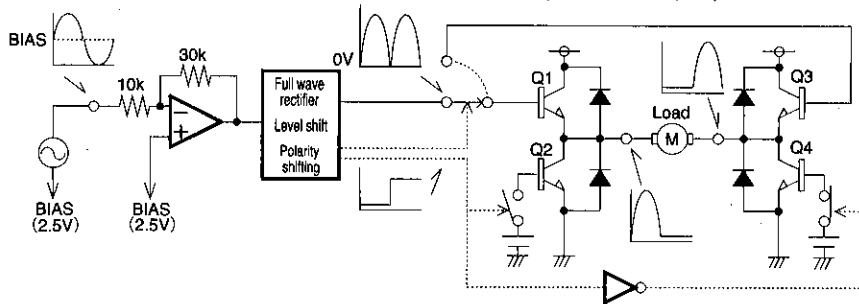

Fig. 2

2. Regulator

This is a typical series regulator that generates a reference voltage internally. A PNP low saturation transistor must be connected.

3. Operational amplifier

A standard 4558 type.

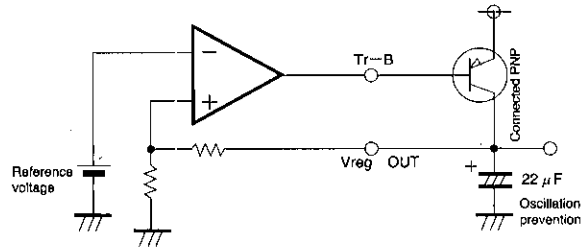

Fig. 3

●Application example

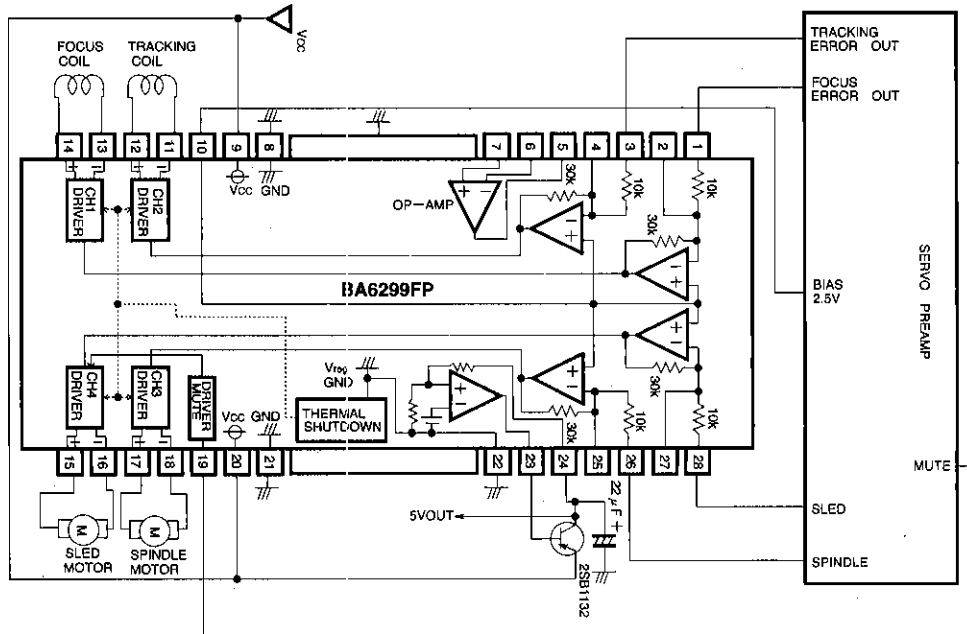

Fig. 4

● Operation notes

1. The BA6299FP has an internal thermal shutdown circuit. Output current is muted when the chip temperature exceeds 175°C (typically).
2. The output current can be muted when the mute pin (19 pin) voltage is opened or lowered below 0.5V.
3. Output is muted when the bias pin (10 pin) voltage drops below 1.4V (typically). Make sure that this pin is at 1.6V or higher under normal operating conditions.
4. All four driver output channels are muted during thermal shutdown, muting and a drop in bias pin voltage. No other components are muted.
5. Dead zone width is determined as follows :
 Dead zone width = input resistance × 1 μA
 For this reason, when using the built-in input resistor (10k Ω), the dead zone becomes 10mV (Typ. single-sided). Because input resistance and 1 μA

temperature characteristics are canceled, there is virtually no variation due to temperature as long as the internal input resistor is used. However, a dead zone like that defined by the above equation occurs when an external resistor is used to change gain. Temperature change is typically -4600ppm per degree, and gain change is typically 4600ppm per degree.

6. Be sure to connect the IC to a 0.1 μF bypass capacitor to the power supply, at the base of the IC.
7. Because of the gain adjustment pin's high gain, connecting a long wire to it may result in output oscillation due to free capacitance. Use caution when designing wires.
8. The capacitor between regulator output (24 pin) and GND also serves to prevent oscillation of the IC, so select one with good temperature characteristics.

● Thermal derating curve

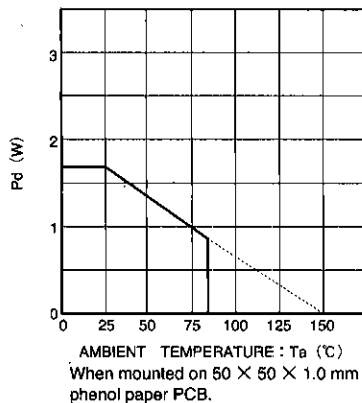

Fig. 5 Thermal derating curve

● Electrical characteristics curve

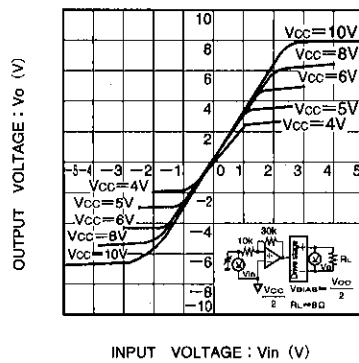

Fig. 6 Driver I/O characteristics (power supply variation)

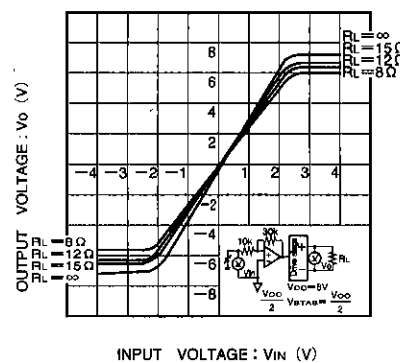

Fig. 7 Driver I/O characteristics (load variation)

CD/CD-ROM Drivers (4 channels)

For CDs/CD-ROMs

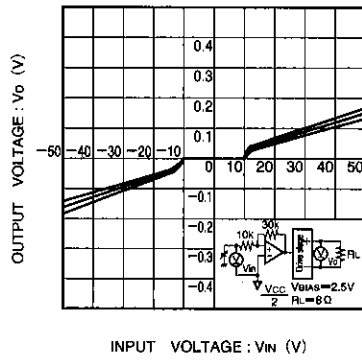

Fig. 8 Dead zone I/O characteristics

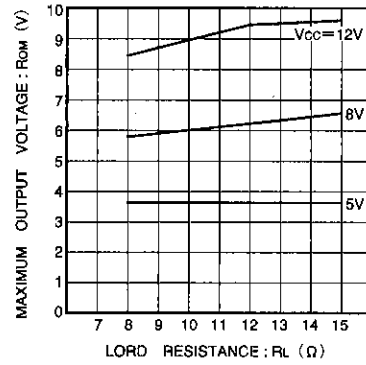

Fig. 9 Load resistance vs. maximum output amplitude

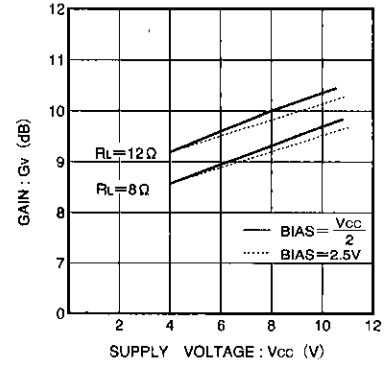

Fig. 10 Driver supply voltage vs. voltage gain

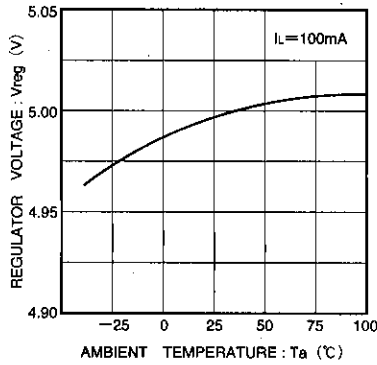

Fig. 11 Regulator voltage vs. temperature

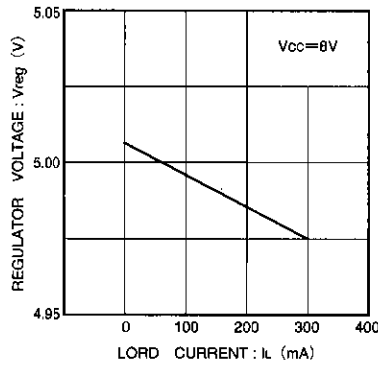

Fig. 12 Load current vs. regulator voltage

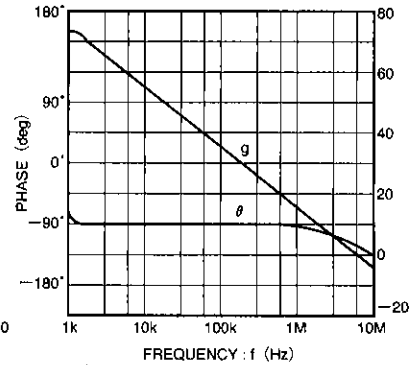

Fig. 13 Operational amplifier (open loop characteristics)

● External dimensions (Units: mm)

