

# DATA SHEET

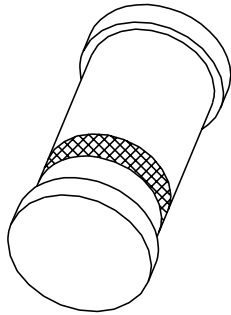

## **BAV100 to BAV103** General purpose diodes

Product specification  
Supersedes data of April 1996

1996 Sep 17

## General purpose diodes

## BAV100 to BAV103

### FEATURES

- Small hermetically sealed glass SMD package
- Switching speed: max. 50 ns
- General application
- Continuous reverse voltage: max. 50 V, 100 V, 150 V and 200 V respectively
- Repetitive peak reverse voltage: max. 60 V, 120 V, 200 V and 250 V respectively
- Repetitive peak forward current: max. 625 mA.

### APPLICATIONS

- Switching in industrial equipment e.g. oscilloscopes, digital voltmeters and video output stages in colour television.

### DESCRIPTION

The BAV100 to BAV103 are switching diodes fabricated in planar technology, and encapsulated in small hermetically sealed glass SOD80C SMD packages.

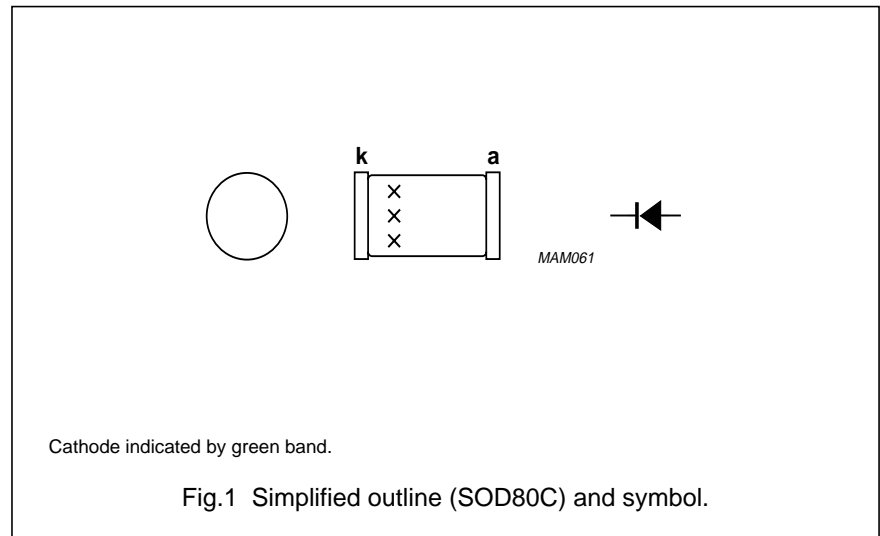

## General purpose diodes

## BAV100 to BAV103

**LIMITING VALUES**

In accordance with the Absolute Maximum Rating System (IEC 134).

SYMBOL	PARAMETER	CONDITIONS	MIN.	MAX.	UNIT
V <sub>RRM</sub>	repetitive peak reverse voltage				
	BAV100		–	60	V
	BAV101		–	120	V
	BAV102		–	200	V
	BAV103		–	250	V
V <sub>R</sub>	continuous reverse voltage				
	BAV100		–	50	V
	BAV101		–	100	V
	BAV102		–	150	V
	BAV103		–	200	V
I <sub>F</sub>	continuous forward current	see Fig.2; note 1	–	250	mA
I <sub>FRM</sub>	repetitive peak forward current		–	625	mA
I <sub>FSM</sub>	non-repetitive peak forward current	square wave; T <sub>j</sub> = 25 °C prior to surge; see Fig.4			
		t = 1 μs	–	9	A
		t = 100 μs	–	3	A
		t = 1 s	–	1	A
P <sub>tot</sub>	total power dissipation	T <sub>amb</sub> = 25 °C; note 1	–	400	mW
T <sub>stg</sub>	storage temperature		–65	+175	°C
T <sub>j</sub>	junction temperature		–	175	°C

**Note**

1. Device mounted on an FR4 printed-circuit board.

## General purpose diodes

## BAV100 to BAV103

**ELECTRICAL CHARACTERISTICS**

$T_j = 25\text{ °C}$ ; unless otherwise specified.

SYMBOL	PARAMETER	CONDITIONS	MIN.	MAX.	UNIT
$V_F$	forward voltage	see Fig.3			
		$I_F = 100\text{ mA}$	–	1.0	V
		$I_F = 200\text{ mA}$	–	1.25	V
$I_R$	reverse current BAV100	see Fig.5			
		$V_R = 50\text{ V}$	–	100	nA
	$V_R = 50\text{ V}; T_j = 150\text{ °C}$	–	100	$\mu\text{A}$	
	BAV101	$V_R = 100\text{ V}$	–	100	nA
		$V_R = 100\text{ V}; T_j = 150\text{ °C}$	–	100	$\mu\text{A}$
	BAV102	$V_R = 150\text{ V}$	–	100	nA
$V_R = 150\text{ V}; T_j = 150\text{ °C}$		–	100	$\mu\text{A}$	
BAV103	$V_R = 200\text{ V}$	–	100	nA	
	$V_R = 200\text{ V}; T_j = 150\text{ °C}$	–	100	$\mu\text{A}$	
$C_d$	diode capacitance	$f = 1\text{ MHz}; V_R = 0$ ; see Fig.6	–	5	pF
$t_{rr}$	reverse recovery time	when switched from $I_F = 30\text{ mA}$ to $I_R = 30\text{ mA}; R_L = 100\ \Omega$ ; measured at $I_R = 3\text{ mA}$ ; see Fig.8	–	50	ns

**THERMAL CHARACTERISTICS**

SYMBOL	PARAMETER	CONDITIONS	VALUE	UNIT
$R_{th\ j-tp}$	thermal resistance from junction to tie-point		300	K/W
$R_{th\ j-a}$	thermal resistance from junction to ambient	note 1	375	K/W

**Note**

1. Device mounted on an FR4 printed-circuit board.

General purpose diodes

BAV100 to BAV103

GRAPHICAL DATA

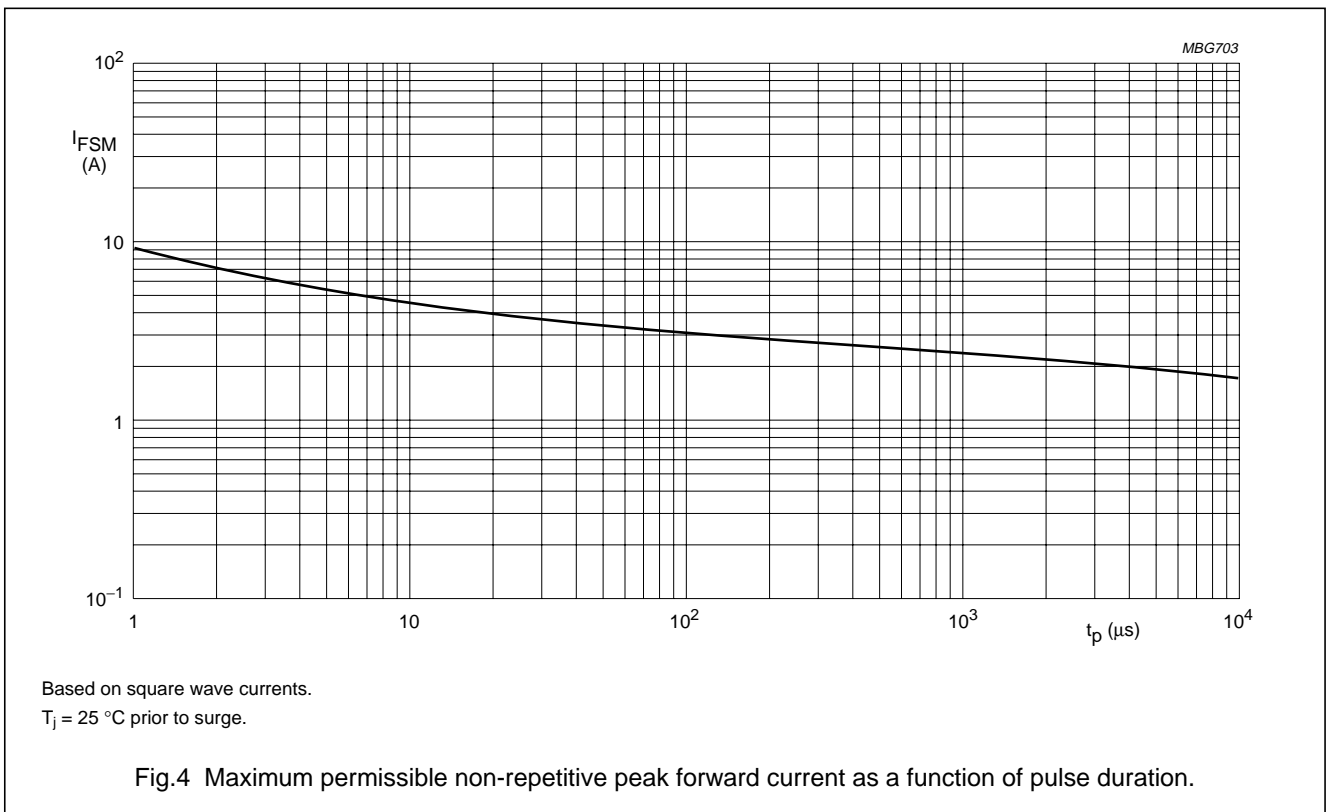
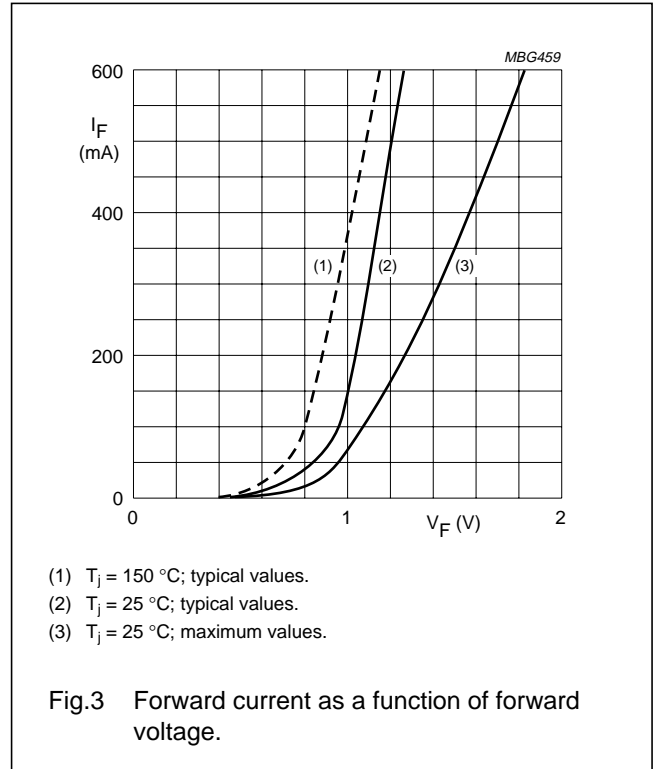
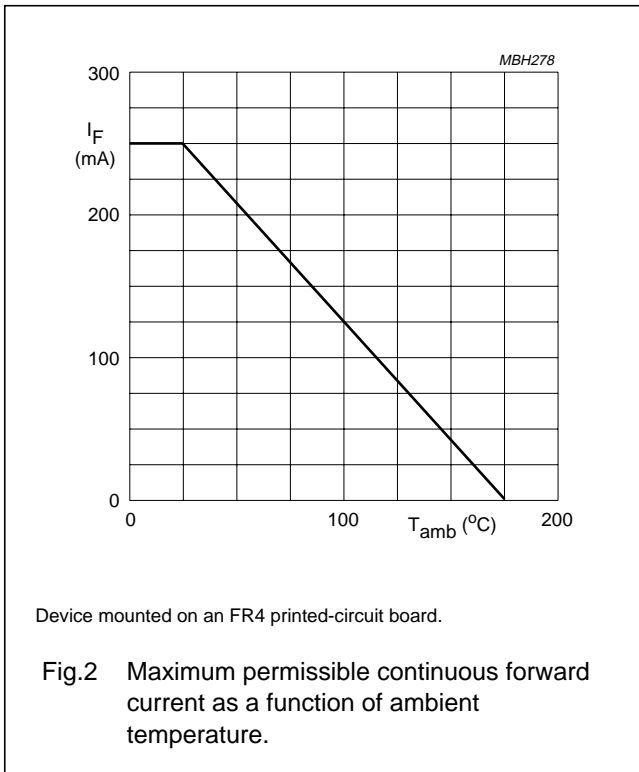

General purpose diodes

BAV100 to BAV103

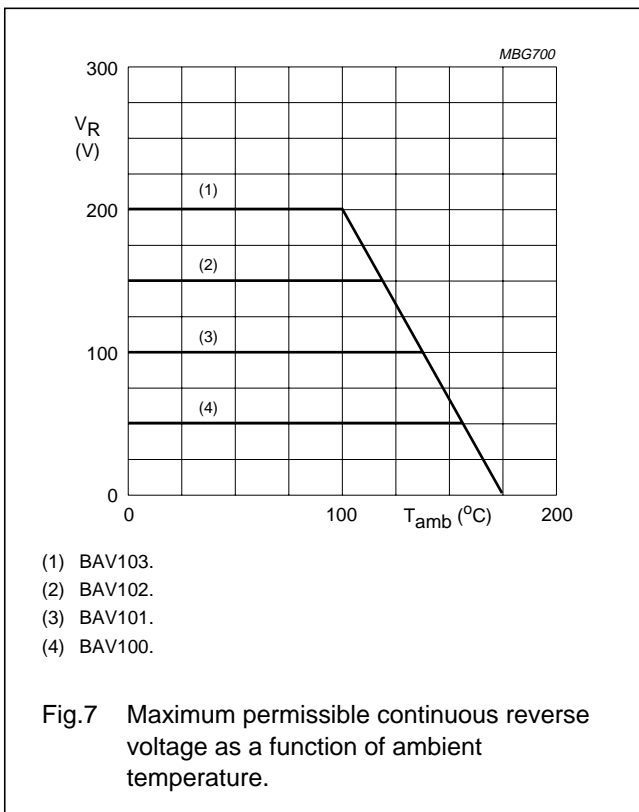
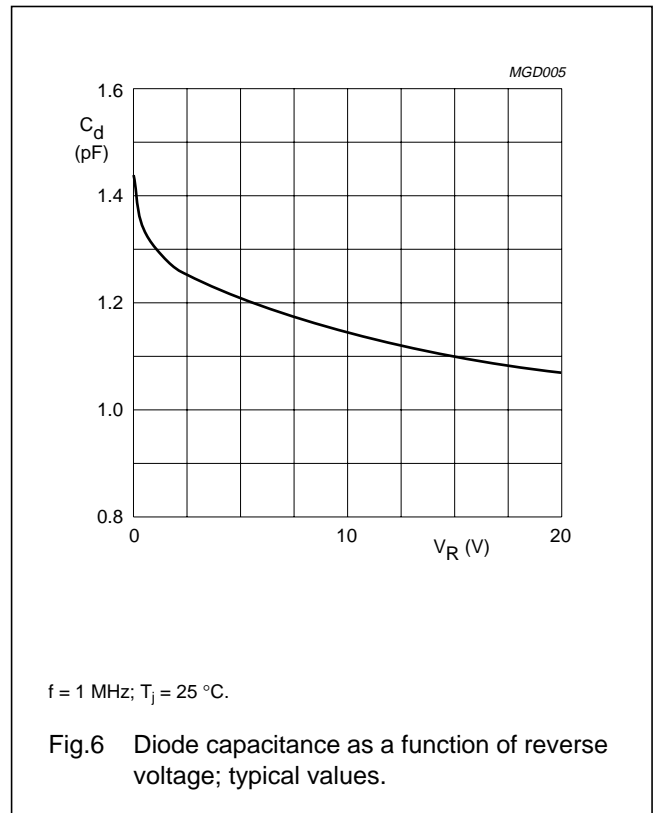
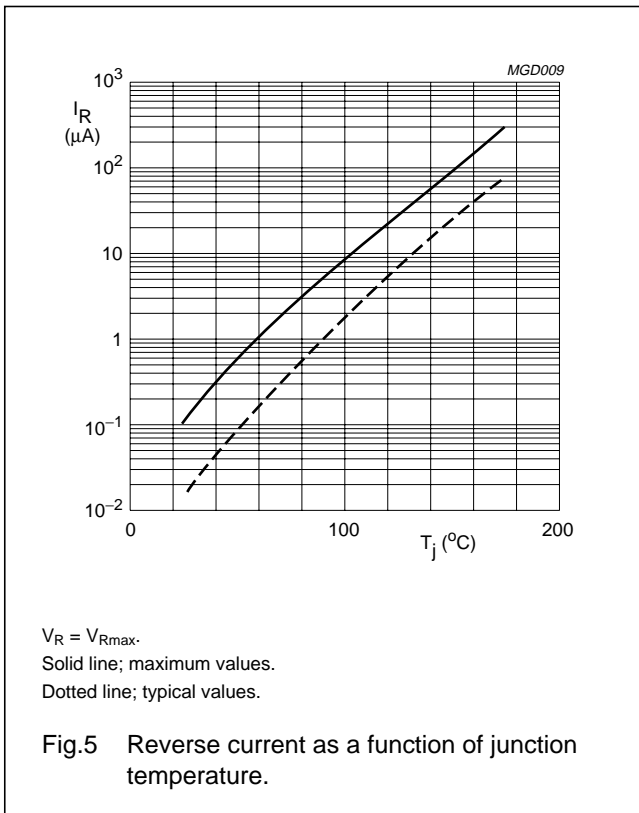

General purpose diodes

BAV100 to BAV103

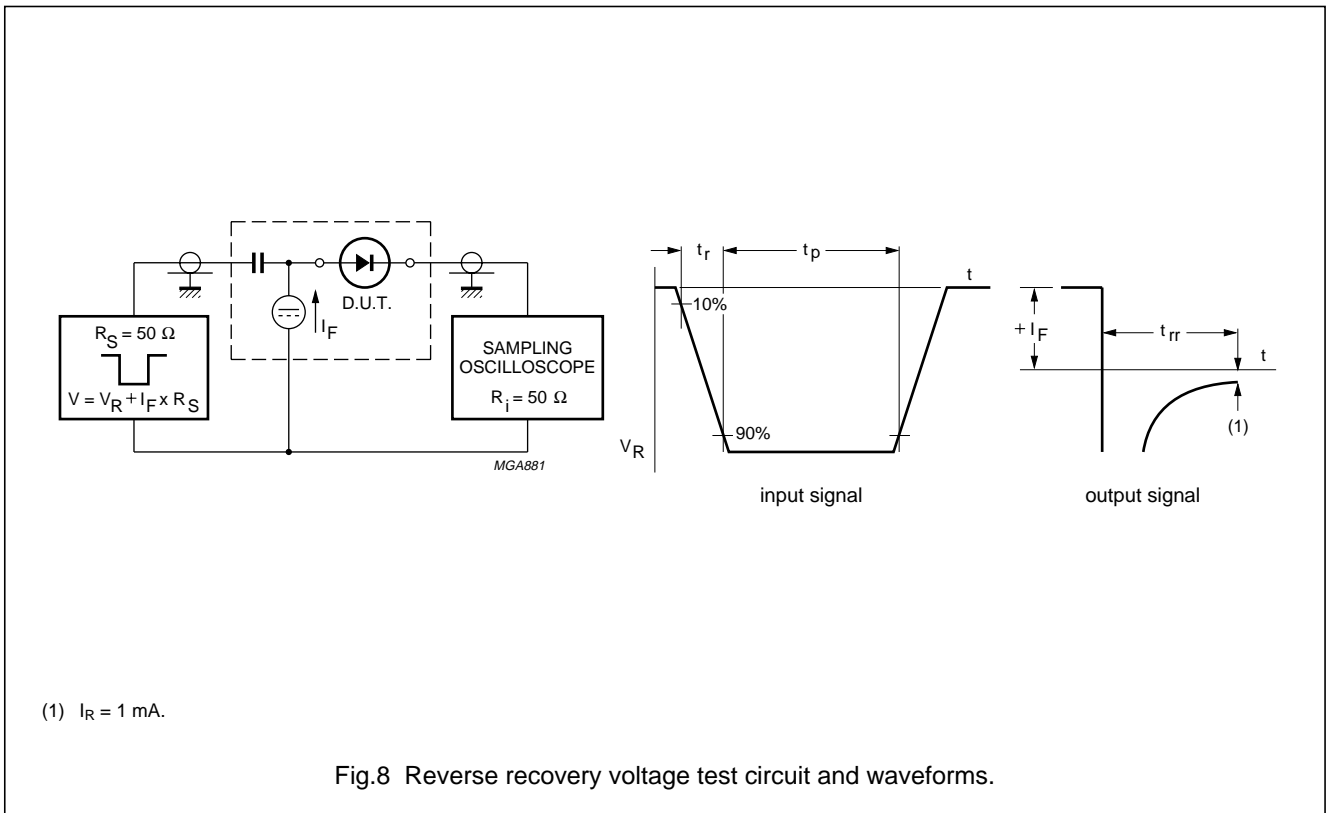

General purpose diodes

BAV100 to BAV103

PACKAGE OUTLINE

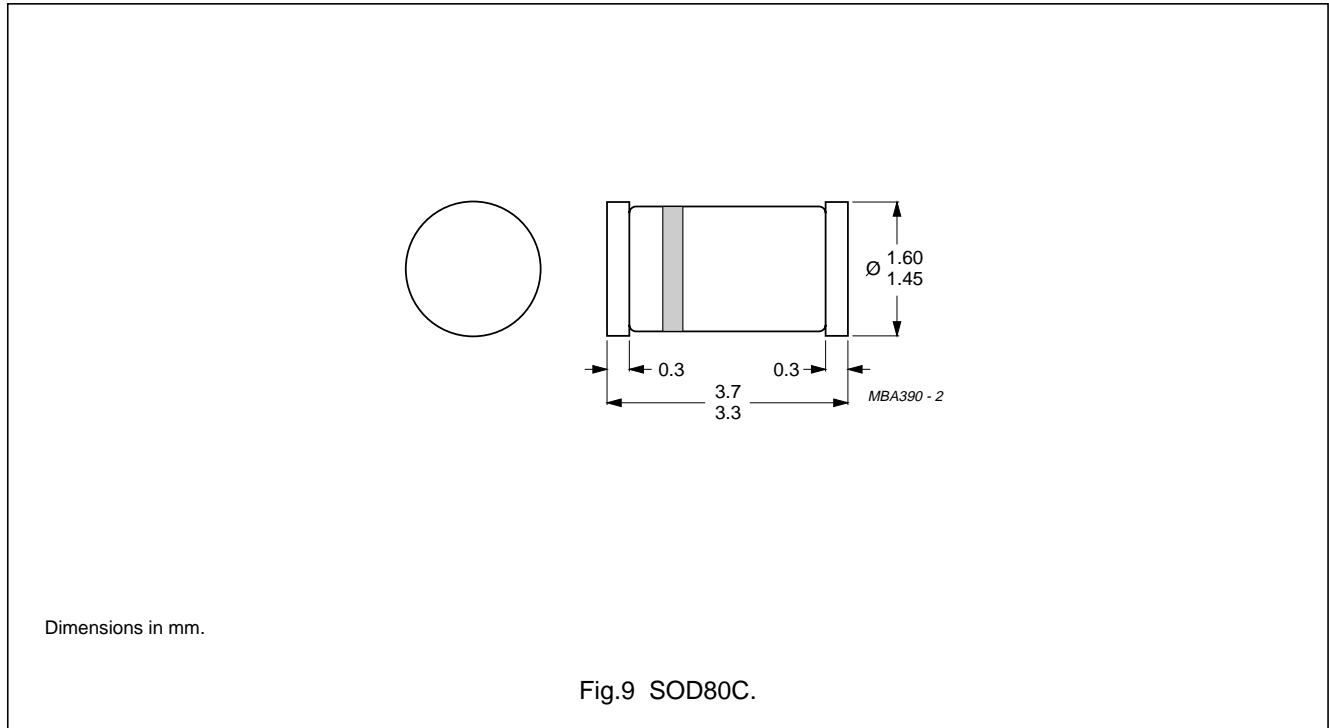

DEFINITIONS

<b>Data Sheet Status</b>	
Objective specification	This data sheet contains target or goal specifications for product development.
Preliminary specification	This data sheet contains preliminary data; supplementary data may be published later.
Product specification	This data sheet contains final product specifications.
<b>Limiting values</b>	
Limiting values given are in accordance with the Absolute Maximum Rating System (IEC 134). Stress above one or more of the limiting values may cause permanent damage to the device. These are stress ratings only and operation of the device at these or at any other conditions above those given in the Characteristics sections of the specification is not implied. Exposure to limiting values for extended periods may affect device reliability.	
<b>Application information</b>	
Where application information is given, it is advisory and does not form part of the specification.	

LIFE SUPPORT APPLICATIONS

These products are not designed for use in life support appliances, devices, or systems where malfunction of these products can reasonably be expected to result in personal injury. Philips customers using or selling these products for use in such applications do so at their own risk and agree to fully indemnify Philips for any damages resulting from such improper use or sale.