



BC846-BC850

NPN SILICON TRANSISTOR

SWITCHING AND AMPLIFIER APPLICATION

■ FEATURES

- * Suitable for automatic insertion in thick and thin-film circuits.
- * Complement to BC856 ... BC860

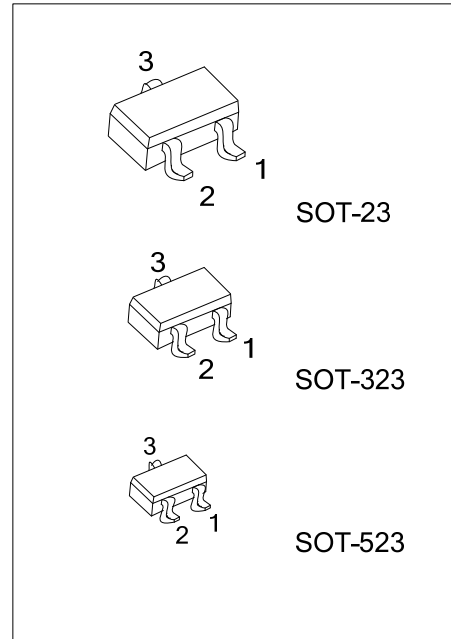

Lead-free:
 BC846L/BC847L/BC848L/BC849L/BC850L
 Halogen-free:
 BC846G/BC847G/BC848G/BC849G/BC850G

■ ORDERING INFORMATION

Ordering Number			Package	Pin Assignment			Packing
Normal	Lead Free	Halogen Free		1	2	3	
BC846-x-AE3-R	BC846L-x-AE3-R	BC846G-x-AE3-R	SOT-23	E	B	C	Tape Reel
BC847-x-AE3-R	BC847L-x-AE3-R	BC847G-x-AE3-R	SOT-23	E	B	C	Tape Reel
BC848-x-AE3-R	BC848L-x-AE3-R	BC848G-x-AE3-R	SOT-23	E	B	C	Tape Reel
BC849-x-AE3-R	BC849L-x-AE3-R	BC849G-x-AE3-R	SOT-23	E	B	C	Tape Reel
BC850-x-AE3-R	BC850L-x-AE3-R	BC850G-x-AE3-R	SOT-23	E	B	C	Tape Reel
BC846-x-AL3-R	BC846L-x-AL3-R	BC846G-x-AL3-R	SOT-323	E	B	C	Tape Reel
BC847-x-AL3-R	BC847L-x-AL3-R	BC847G-x-AL3-R	SOT-323	E	B	C	Tape Reel
BC848-x-AL3-R	BC848L-x-AL3-R	BC848G-x-AL3-R	SOT-323	E	B	C	Tape Reel
BC849-x-AL3-R	BC849L-x-AL3-R	BC849G-x-AL3-R	SOT-323	E	B	C	Tape Reel
BC850-x-AL3-R	BC850L-x-AL3-R	BC850G-x-AL3-R	SOT-323	E	B	C	Tape Reel
BC846-x-AN3-R	BC846L-x-AN3-R	BC846G-x-AN3-R	SOT-523	E	B	C	Tape Reel
BC847-x-AN3-R	BC847L-x-AN3-R	BC847G-x-AN3-R	SOT-523	E	B	C	Tape Reel
BC848-x-AN3-R	BC848L-x-AN3-R	BC848G-x-AN3-R	SOT-523	E	B	C	Tape Reel
BC849-x-AN3-R	BC849L-x-AN3-R	BC849G-x-AN3-R	SOT-523	E	B	C	Tape Reel
BC850-x-AN3-R	BC850L-x-AN3-R	BC850G-x-AN3-R	SOT-523	E	B	C	Tape Reel

<p>BC846L-x-AE3-R</p> <p>(1)Packing Type (2)Package Type (3)Rank (4)Lead Plating</p>	<p>(1) R: Tape Reel (2) AE3: SOT-23, AL3: SOT-323, AN3: SOT-523 (3) x: refer to Classification of h_{FE} (4) G: Halogen Free, L: Lead Free, Blank: Pb/Sn</p>
---	--

BC846-BC850

NPN SILICON TRANSISTOR

MARKING

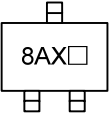
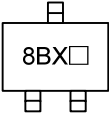
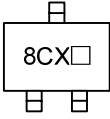
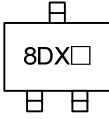
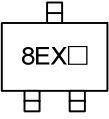
BC846	BC847	BC848	BC849	BC850
				

X: Rank Code, refer to Classification of h_{FE}

□: L: Lead Free, G: Halogen Free

BC846-BC850

NPN SILICON TRANSISTOR

■ ABSOLUTE MAXIMUM RATING (Ta=25°C, unless otherwise specified)

PARAMETER		SYMBOL	VALUE	UNIT
Collector-Base Voltage	BC846	V _{CBO}	80	V
	BC847 / BC850		50	V
	BC848 / BC849		30	V
Collector-Emitter Voltage	BC846	V _{CEO}	65	V
	BC847 / BC850		45	V
	BC848 / BC849		30	V
Emitter-Base Voltage	BC846 / BC847	V _{EBO}	6	V
	BC848 / BC849 / BC850		5	V
Collector Current (DC)		I _c	100	mA
Collector Dissipation	SOT-23	P _D	310	mW
	SOT-323		200	mW
	SOT-523		150	mW
Junction Temperature		T _J	+150	°C
Storage Temperature		T _{STG}	-40 ~ +150	°C

Note: Absolute maximum ratings are those values beyond which the device could be permanently damaged.
Absolute maximum ratings are stress ratings only and functional device operation is not implied.

■ ELECTRICAL CHARACTERISTICS (Ta=25°C, unless otherwise specified)

PARAMETER		SYMBOL	TEST CONDITIONS	MIN	TYP	MAX	UNIT
Collector Cut-Off Current		I _{CBO}	V _{CB} =30V, I _E =0			15	nA
DC Current Gain		h _{FE}	V _{CE} =5.0V, I _c =2.0mA	110		800	
Collector-Emitter Saturation Voltage	V _{CE(SAT)}		I _c =10mA, I _B =0.5mA		90	250	mV
			I _c =100mA, I _B =5.0mA		200	600	mV
Collector-Base Saturation Voltage	V _{BE(SAT)}		I _c =10mA, I _B =0.5mA		700		mV
			I _c =100mA, I _B =5.0mA		900		mV
Base-Emitter On Voltage	V _{BE(ON)}		V _{CE} =5.0V, I _c =2.0mA	580	660	700	mV
			V _{CE} =5.0V, I _c =10mA			720	mV
Current Gain Bandwidth Product		f _T	V _{CE} =5.0V, I _c =10mA f=100MHz		300		MHz
Output Capacitance		C _{ob}	V _{CB} =10V, I _E =0, f=1.0MHz		3.5	6	pF
Input Capacitance		C _{ib}	V _{EB} =0.5V, I _C =0, f=1.0MHz		9		pF
Noise Figure	BC846/BC847/BC848	NF	V _{CE} =5V, I _c =200μA, f=1KHz, R _G =2KΩ		2	10	dB
	BC849/BC850				1.2	4	dB
	BC849				1.4	4	dB
	BC850				1.4	3	dB

■ CLASSIFICATION OF h_{FE}

RANK	A	B	C
RANGE	110-220	200-450	420-800

TYPICAL CHARACTERISTICS

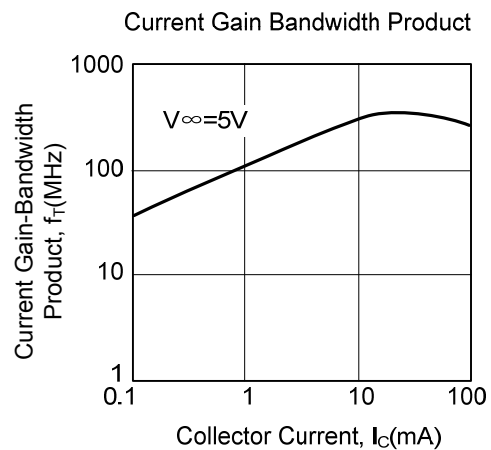
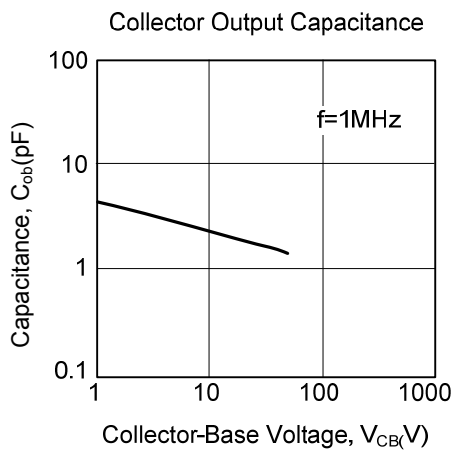
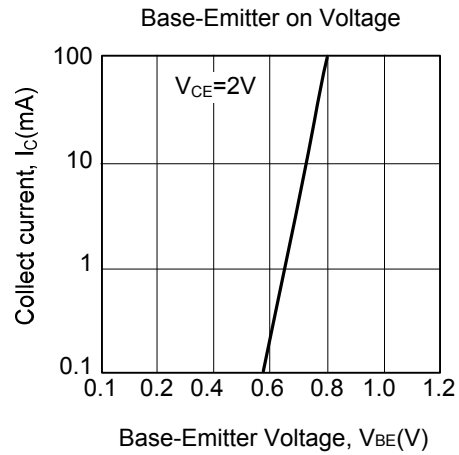
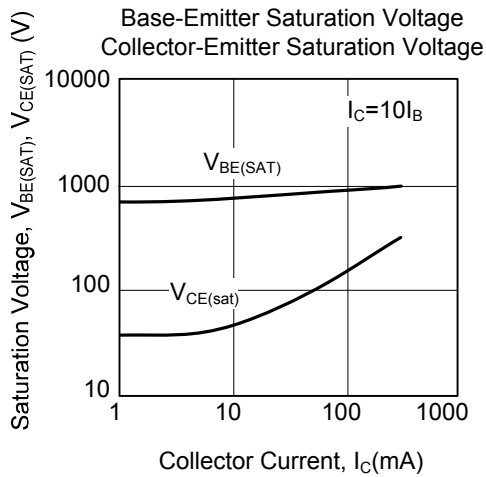
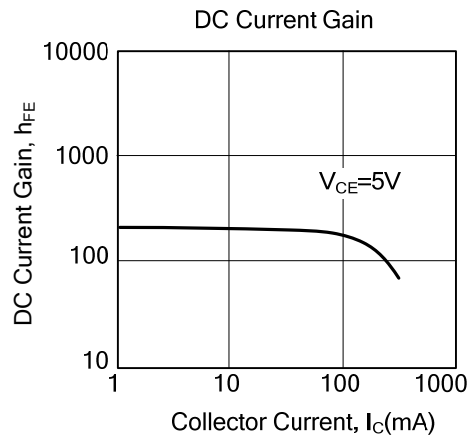
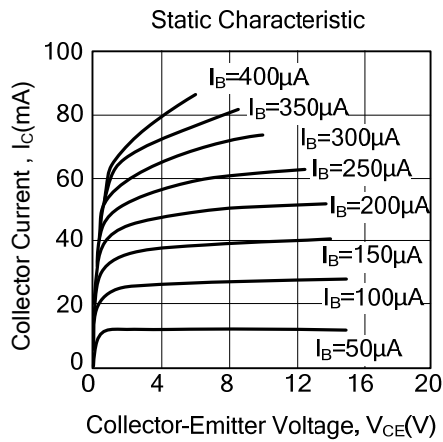

UTC assumes no responsibility for equipment failures that result from using products at values that exceed, even momentarily, rated values (such as maximum ratings, operating condition ranges, or other parameters) listed in products specifications of any and all UTC products described or contained herein. UTC products are not designed for use in life support appliances, devices or systems where malfunction of these products can be reasonably expected to result in personal injury. Reproduction in whole or in part is prohibited without the prior written consent of the copyright owner. The information presented in this document does not form part of any quotation or contract, is believed to be accurate and reliable and may be changed without notice.