

# BCR20A, BCR20B, BCR20C, BCR20E

MEDIUM POWER USE

A, B, C : NON-INSULATED TYPE, E : INSULATED TYPE, GLASS PASSIVATION TYPE

BCR20A, BCR20B, BCR20C, BCR20E



- $I_T$  (RMS) ..... 20A
- $V_{DRM}$  ..... 400V/500V
- $I_{FGT I}$ ,  $I_{RGT I}$ ,  $I_{RGT III}$  ..... 30mA

## OUTLINE DRAWING

Dimensions  
in mm

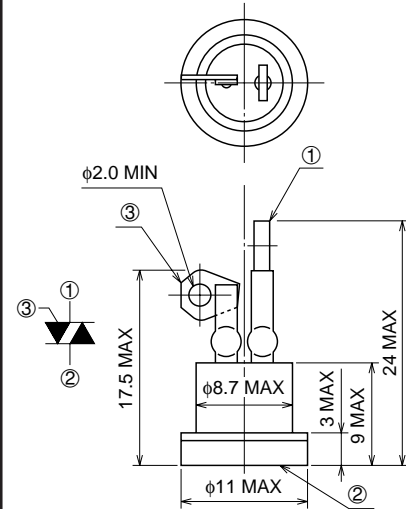

- ① T<sub>1</sub> TERMINAL
- ② T<sub>2</sub> TERMINAL
- ③ GATE TERMINAL

BCR20A

## APPLICATION

Contactless AC switches, light dimmer,  
on/off control of traffic signals, on/off control of copier lamps, microwave ovens,  
solid state relay

## MAXIMUM RATINGS

Symbol	Parameter	Voltage class		Unit
		8	12	
$V_{DRM}$	Repetitive peak off-state voltage*1	400	500	V
$V_{DSM}$	Non-repetitive peak off-state voltage*1	600	700	V

Symbol	Parameter	Conditions		Ratings	Unit
		BCR20A, B, C	BCR20E		
$I_T$ (RMS)	RMS on-state current	Commercial frequency, sine full wave, 360° conduction	$T_c=98^\circ\text{C}$	20	A
$I_{TSM}$	Surge on-state current	60Hz sinewave 1 full cycle, peak value, non-repetitive		220	A
$I^2t$	$I^2t$ for fusing	Value corresponding to 1 cycle of half wave 60Hz, surge on-state current		203	A <sup>2</sup> s
PGM	Peak gate power dissipation			5.0	W
PG (AV)	Average gate power dissipation			0.5	W
VGM	Peak gate voltage			10	V
IGM	Peak gate current			2.0	A
$T_j$	Junction temperature			-20 ~ +125	°C
$T_{stg}$	Storage temperature			-20 ~ +125	°C

\*1. Gate open.

# BCR20A, BCR20B, BCR20C, BCR20E

MEDIUM POWER USE

A, B, C : NON-INSULATED TYPE, E : INSULATED TYPE, GLASS PASSIVATION TYPE

## MAXIMUM RATINGS (continue)

Symbol	Parameter	Conditions	Ratings	Unit
—	Weight (Typical value)	BCR20A	3.5	g
		BCR20B	9.0	
		BCR20C	9.0	
		BCR20E	11	
—	Soldering temperature	BCR20A only, 10 sec.	230	°C
—	Mounting torque	BCR20C only	30	kg-cm
			2.94	N-m
Viso	Isolated voltage	BCR20E only, Ta=25°C, AC 1 minute, T2 terminal to base	1500	V

## ELECTRICAL CHARACTERISTICS

Symbol	Parameter	Test conditions	Limits			Unit	
			Min.	Typ.	Max.		
IDRM	Repetitive peak off-state current	Tj=125°C, VDRM applied	—	—	3.0	mA	
VTM	On-state voltage	Tc=25°C, Tb=25°C (BCR20E only), ITM=30A, Instantaneous measurement	—	—	1.5	V	
VFGT I	Gate trigger voltage *2	Tj=25°C, Vd=6V, RL=6Ω, RG=330Ω	I	—	—	1.5	V
VRGT I			II	—	—	1.5	V
VRGT III			III	—	—	1.5	V
IFGT I	Gate trigger current *2	Tj=25°C, Vd=6V, RL=6Ω, RG=330Ω	I	—	—	30	mA
IRGT I			II	—	—	30	mA
IRGT III			III	—	—	30	mA
VGD	Gate non-trigger voltage	Tj=125°C, Vd=1/2VDRM	0.2	—	—	V	
Rth (j-c)	Thermal resistance	Junction to case (BCR20A, BCR20B, BCR20C)	—	—	1.1	°C/W	
Rth (j-b)		Junction to base (BCR20E)	—	—	2.4	°C/W	
(dv/dt)c	Critical-rate of rise of off-state commutating voltage		*3	—	—	V/μs	

\*2. Measurement using the gate trigger characteristics measurement circuit.

\*3. The critical-rate of rise of the off-state commutating voltage is shown in the table below.

Voltage class	VDRM (V)	(dv/dt) c			Test conditions	Commutating voltage and current waveforms (inductive load)
		Symbol	Min.	Unit		
8	400	R	—	V/μs	1. Junction temperature Tj=125°C 2. Rate of decay of on-state commutating current (di/dt)c=-10A/ms 3. Peak off-state voltage Vd=400V	
		L	10			
10	600	R	—			
		L	10			

# BCR20A, BCR20B, BCR20C, BCR20E

MEDIUM POWER USE

A, B, C : NON-INSULATED TYPE, E : INSULATED TYPE, GLASS PASSIVATION TYPE

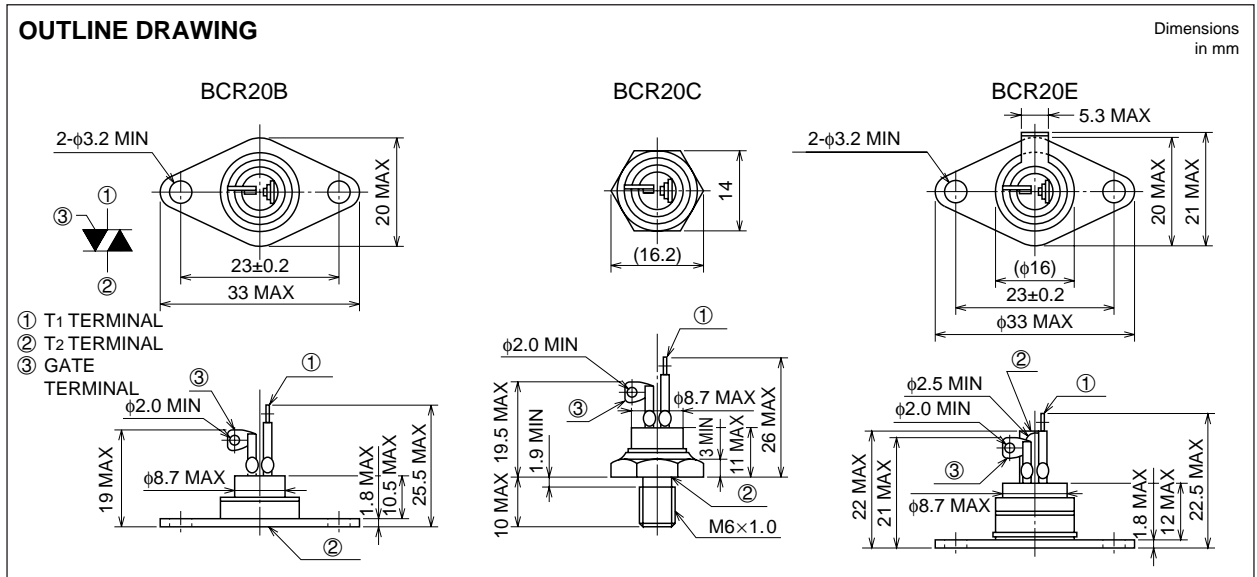

### PERFORMANCE CURVES

MAXIMUM ON-STATE CHARACTERISTICS

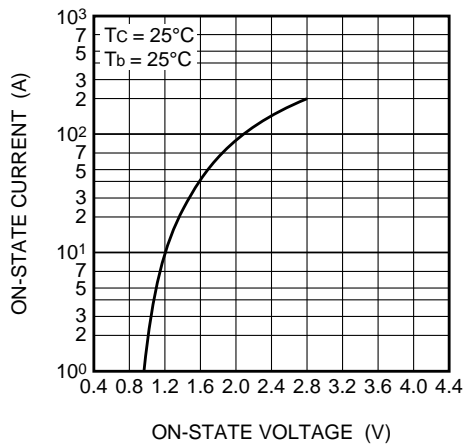

RATED SURGE ON-STATE CURRENT

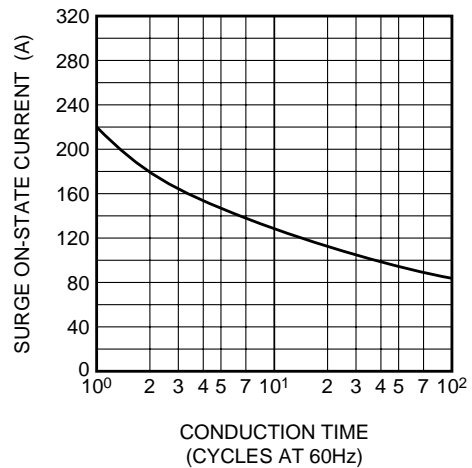

GATE CHARACTERISTICS

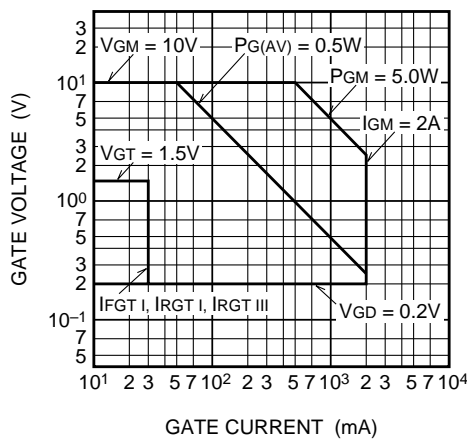

GATE TRIGGER CURRENT-VOLTAGE VS. JUNCTION TEMPERATURE

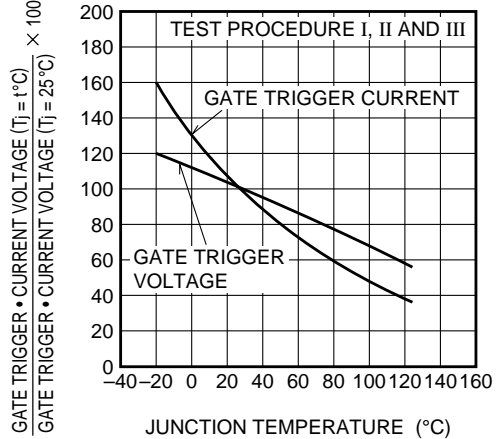

# BCR20A, BCR20B, BCR20C, BCR20E

MEDIUM POWER USE

A, B, C : NON-INSULATED TYPE, E : INSULATED TYPE, GLASS PASSIVATION TYPE

**MAXIMUM TRANSIENT THERMAL IMPEDANCE CHARACTERISTICS (JUNCTION TO CASE) (BCR20A, B, C)**

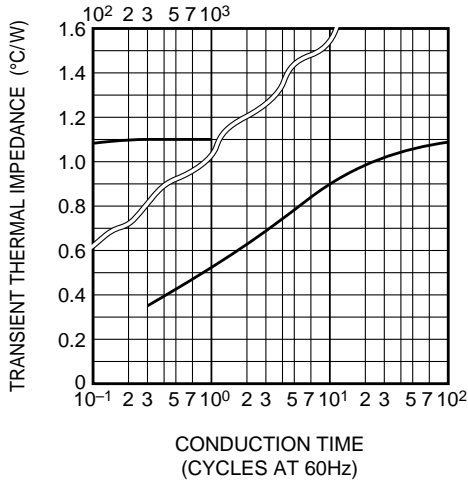

**MAXIMUM TRANSIENT THERMAL IMPEDANCE CHARACTERISTICS (JUNCTION TO BASE) (BCR20E)**

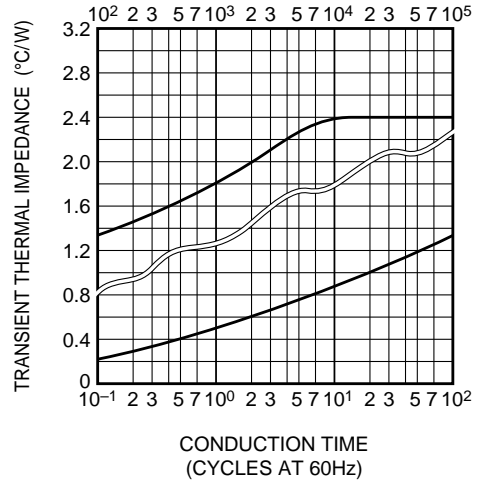

**MAXIMUM ON-STATE POWER DISSIPATION**

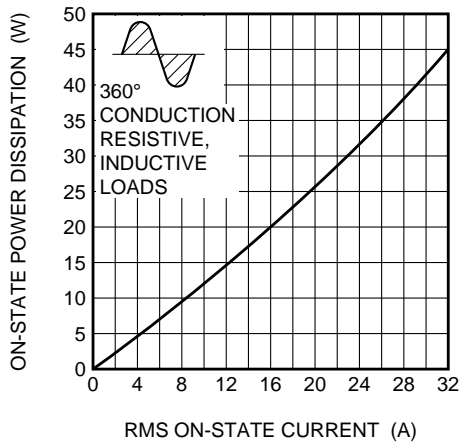

**ALLOWABLE CASE TEMPERATURE VS. RMS ON-STATE CURRENT**

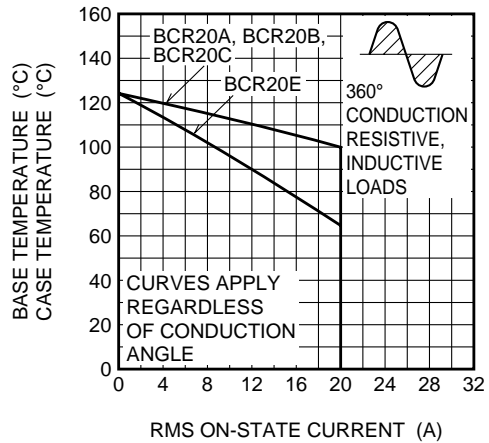

**ALLOWABLE AMBIENT TEMPERATURE VS. RMS ON-STATE CURRENT (BCR20A)**

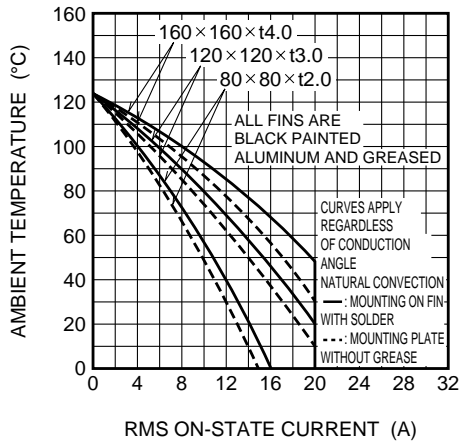

**ALLOWABLE AMBIENT TEMPERATURE VS. RMS ON-STATE CURRENT (BCR20B)**

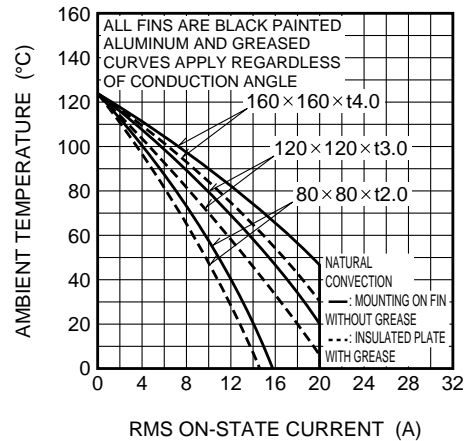

# BCR20A, BCR20B, BCR20C, BCR20E

MEDIUM POWER USE

A, B, C : NON-INSULATED TYPE, E : INSULATED TYPE, GLASS PASSIVATION TYPE

**ALLOWABLE AMBIENT TEMPERATURE  
VS. RMS ON-STATE CURRENT  
(BCR20C)**

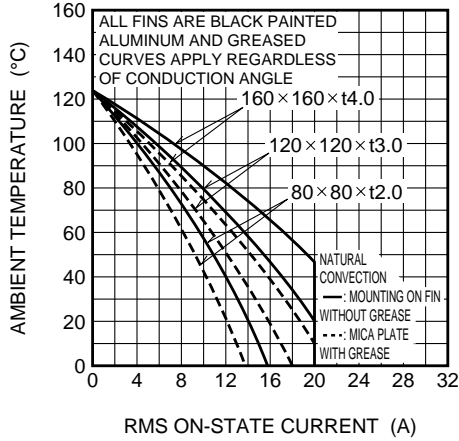

**ALLOWABLE AMBIENT TEMPERATURE  
VS. RMS ON-STATE CURRENT  
(BCR20E)**

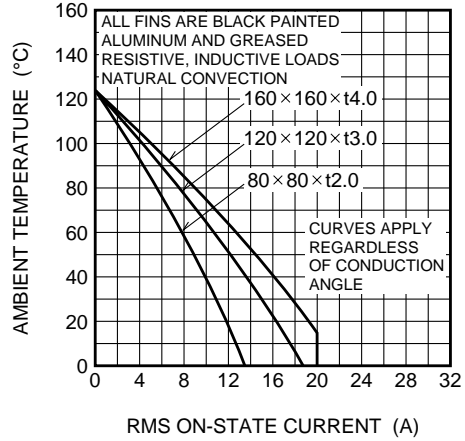

**GATE TRIGGER CHARACTERISTICS TEST CIRCUITS**

