

High Performance Class-D Speaker Amplifier Series

7W+7W Class-D

Speaker Amplifier for Analog Input



BD5427MUV

No.09075EAT07

● Overview

BD5427MUV is a 7W + 7W stereo class-D power amplifier IC, developed for space-saving and low heat-generation applications such as low-profile TV sets. The IC employs state-of-the-art Bipolar, CMOS, and DMOS (BCD) process technology that eliminates turn-on resistance in the output power stage and internal loss due to line resistances up to an ultimate level. With this technology, the IC has achieved high efficiency of 80% (7W + 7W output with 8Ω load), which is the top class in the industry. The IC, in addition, employs a compact back-surface heat radiation type power package to achieve low power consumption and low heat generation and eliminates necessity of installing an external radiator, up to a total output of 14W. This product satisfies both needs for drastic downsizing, low-profile structures and powerful, high-quality playback of the sound system.

● Features

- 1) A high efficiency of 80% (7W + 7W output with 8Ω load), which is the highest grade in the industry and low heat-generation.
- 2) Driving a lowest rating load of 6Ω is allowed.
- 3) Pop noise upon turning power on/off and power interruption has been reduced.
- 4) High-quality audio muting is implemented by soft-switching technology.
- 5) High-reliability design provided with built-in protection circuits against high temperatures, against VCC shorting and GND shorting, against reduced-voltage, and against applying DC voltage to speaker.
- 6) A master/slave function allowing synchronization of multiple devices reduces beat noises.
- 7) Adjustment of internal PWM sampling clock frequencies (250kHz to 400kHz) allows easy protective measures against unwanted radio emission to AM radio band.
- 8) A compact back-surface heat radiation type power package is employed.
VQFN048V7070 7.0mm × 7.0mm × 1.0mm, pitch 0.5mm

● Absolute Maximum Ratings

A circuit must be designed and evaluated not to exceed absolute maximum rating in any cases and even momentarily, to prevent reduction in functional performances and thermal destruction of a semiconductor product and secure useful life and reliability.

The following values assume $T_a = 25^\circ\text{C}$. For latest values, refer to delivery specifications.

Item	Symbol	Rating	Unit	Conditions
Supply voltage	V_{CC}	+20	V	Pin 2, 14, 15, 22, 23, 38, 39, 46, 47 (Note 1, 2)
Power dissipation	P_d	3.28	W	(Note 3)
		4.8	W	(Note 4)
Input voltage for signal pin	V_{IN}	-0.2 ~ +7.2	V	Pin 6, 7 (Note 1)
Input voltage for control pin	V_{CONT}	-0.2 ~ $V_{CC}+0.2$	V	Pin 28, 32 (Note 1)
Input voltage for clock pin	V_{OSC}	-0.2 ~ +7.2	V	Pin 31 (Note 1)
Operating temperature range	T_{opr}	-40 ~ +85	$^\circ\text{C}$	
Storage temperature range	T_{stg}	-55 ~ +150	$^\circ\text{C}$	
Maximum junction temperature	T_{jmax}	+150	$^\circ\text{C}$	

(Note 1) A voltage that can be applied with reference to GND (pins 5, 18, 19, 42, and 43)

(Note 2) P_d and $T_{jmax}=150^\circ\text{C}$ must not be exceeded.

(Note 3) 114.3mm x 76.2mm x 1.6mm FR4 2-layer glass epoxy board (Copper Area 5505mm²) installed.

If used under $T_a=25^\circ\text{C}$ or higher, reduce 26.2mW for increase of every 1 $^\circ\text{C}$. The board is provided with thermal via.

(Note 4) 114.3mm x 76.2mm x 1.6mm FR4 4-layer glass epoxy board (Copper Area 5505mm²) installed.

If used under $T_a=25^\circ\text{C}$ or higher, reduce 38.4mW for increase of every 1 $^\circ\text{C}$. The board is provided with thermal via.

● Operating Conditions

The following values assume $T_a = 25^\circ\text{C}$. Check for latest values in delivery specifications.

Item	Symbol	Rating	Unit	Conditions
Supply voltage	V_{CC}	+10~+16.5	V	Pin 2, 14, 15, 22, 23, 38, 39, 46, 47
Load resistance	R_L	6 ~ 16	Ω	(Note 5)

(Note 5) P_d should not be exceeded.

● Electrical Characteristics

Except otherwise specified $T_a = 25^\circ\text{C}$, $V_{CC} = 12\text{V}$, $f_{IN} = 1\text{kHz}$, $R_g = 0\Omega$, $R_L = 8\Omega$, MUTEX="H", MS="L"

For latest values, refer to delivery specifications.

Item	Symbol	Representative value	Unit	Conditions
Whole circuit				
Circuit current 1 (Sampling mode)	I_{CC1}	25	mA	With no signal
Circuit current 2 (Muting mode)	I_{CC2}	10	mA	MUTEX = "L"
Control circuit				
"H" level input voltage	V_{IH}	2.3~12	V	MUTEX, MS
"L" level input voltage	V_{IL}	0~0.8	V	MUTEX, MS
Audio circuit				
Voltage gain	G_V	28	dB	$P_o = 1\text{W}$
Maximum output power (Note 6)	P_o	7	W	THD+N = 10%
Total harmonic distortion (Note 6)	THD	0.1	%	$P_o = 1\text{W}$, BW=20Hz~20kHz
Crosstalk	CT	85	dB	$P_o = 1\text{W}$, $R_g = 0\Omega$, BW = IHF-A
Output noise voltage (Sampling mode)	V_{NO}	80	μVrms	$R_g = 0\Omega$, BW = IHF-A
Residual noise voltage (Muting mode)	V_{NOM}	1	μVrms	$R_g = 0\Omega$, BW = IHF-A, MUTEX = "L"
Internal sampling clock frequency	F_{OSC}	250	kHz	MS = "L" (In master operation)

(Note 6) The rated values of items above indicate average performances of the device, which largely depend on circuit layouts, components, and power supplies. The reference values are those applicable to the device and components directly installed on a board specified by us.

●Electrical characteristic curves (Reference data)

(1) Under Stereo Operation ($R_L=8\Omega$)

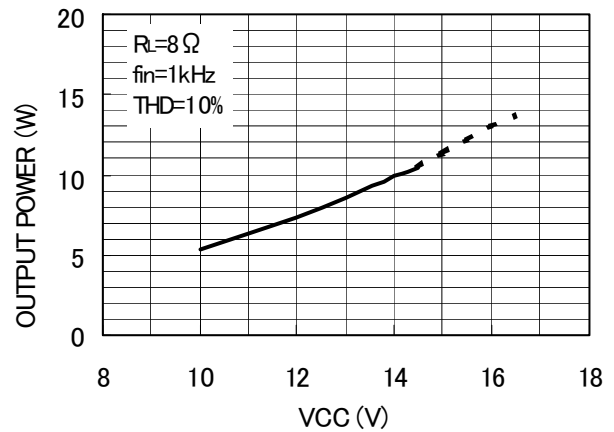
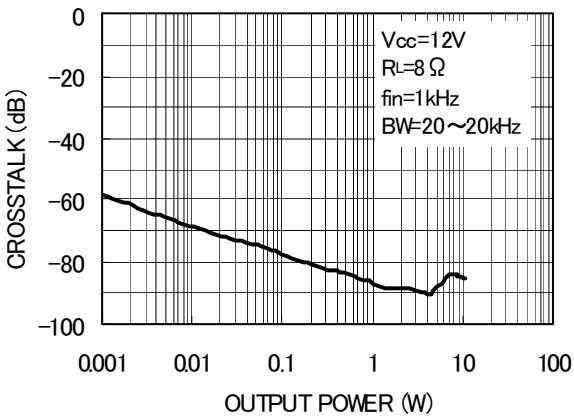
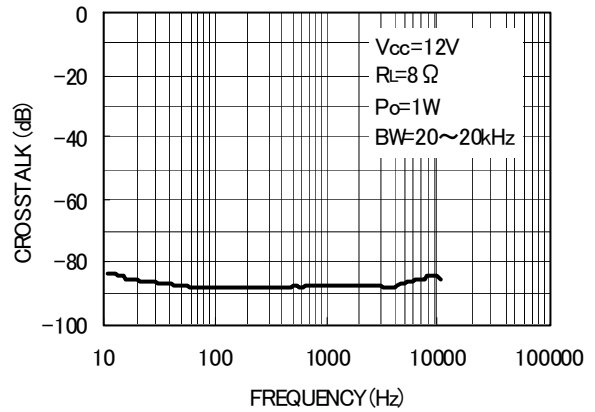
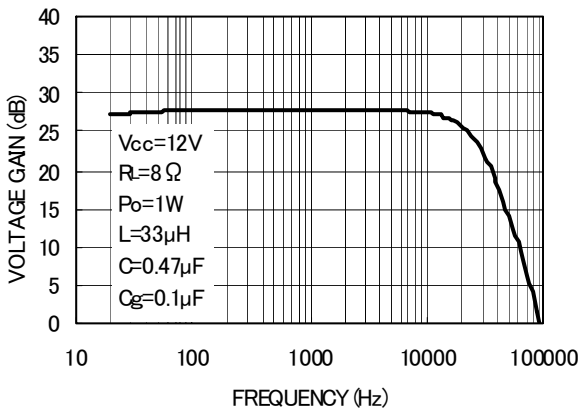
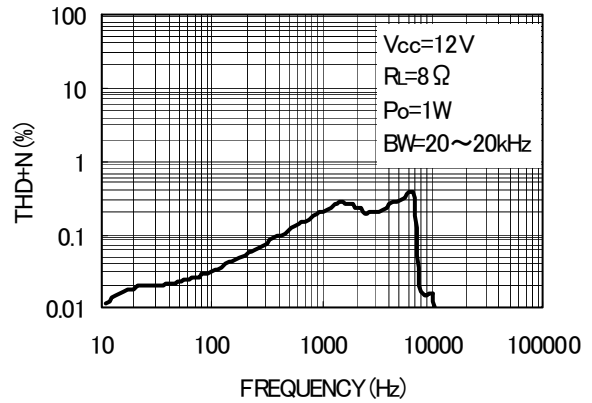
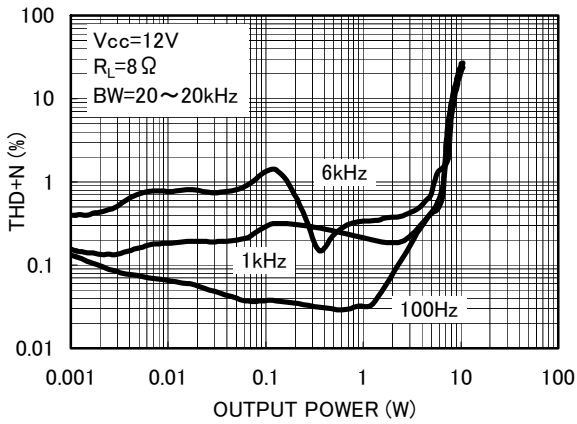

●Electrical characteristic curves (Reference data) – Continued

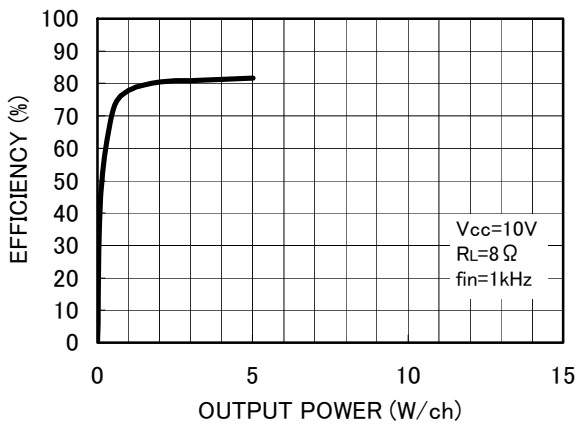

Fig. 7 Efficiency - Output power

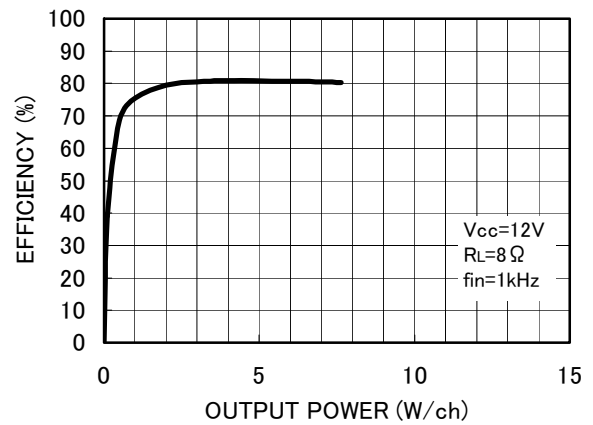

Fig. 8 Efficiency - Output power

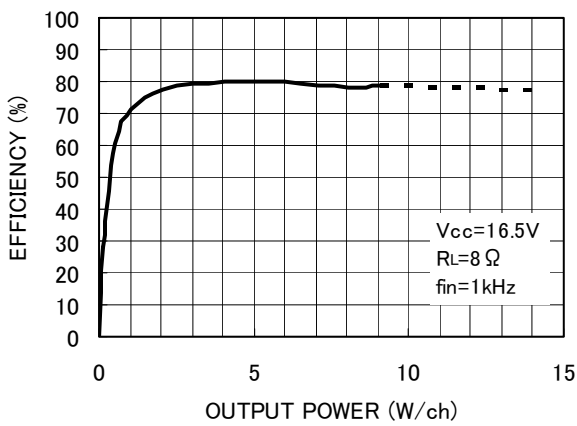

Fig. 9 Efficiency - Output power

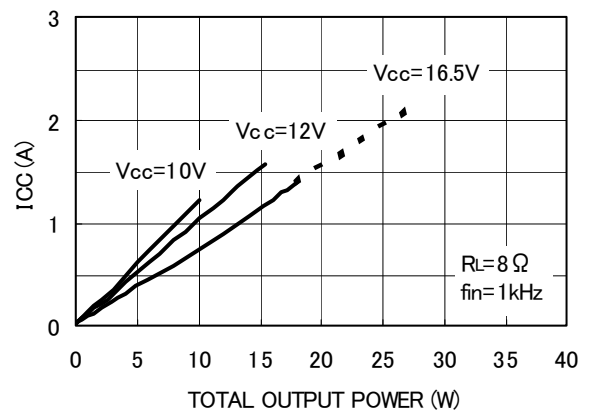

Fig. 10 Current consumption - Output power

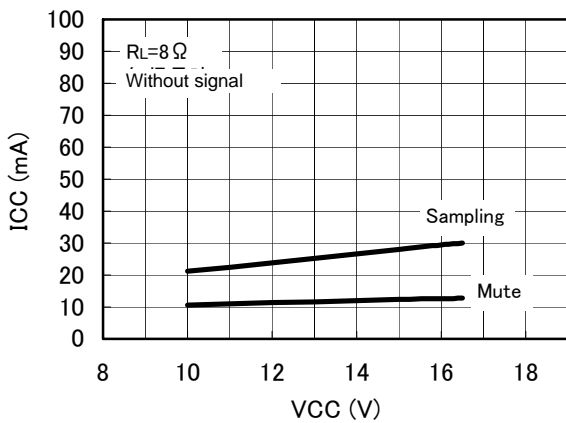

Fig. 11 Current consumption - Power supply voltage

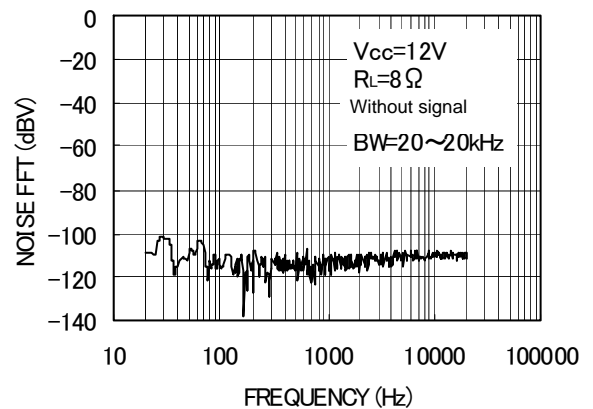

Fig. 12 FFT of Output Noise Voltage

●Electrical characteristic curves (Reference data) – Continued

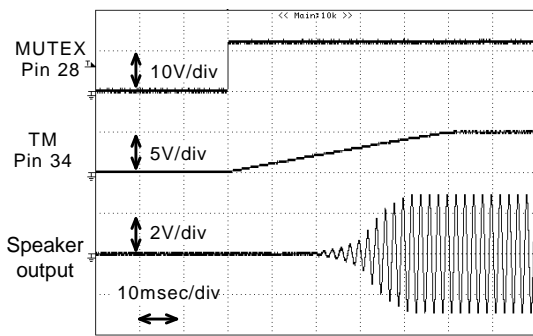

Fig. 13 Wave form when Releasing Soft-mute

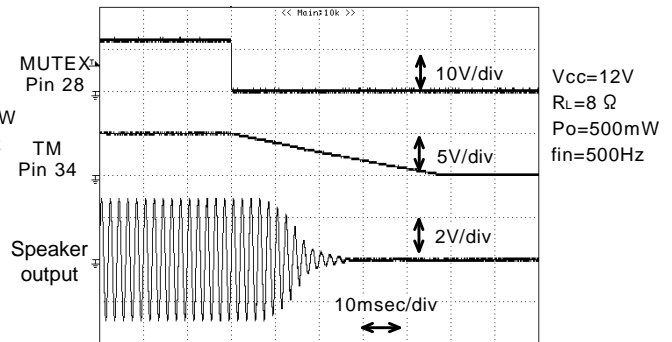

Fig. 14 Wave form when Activating Soft-mute

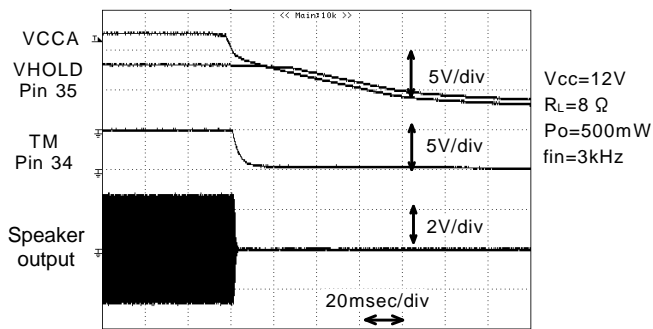

Fig. 15 Wave form on Instantaneous Power Interruption (20msec / div)

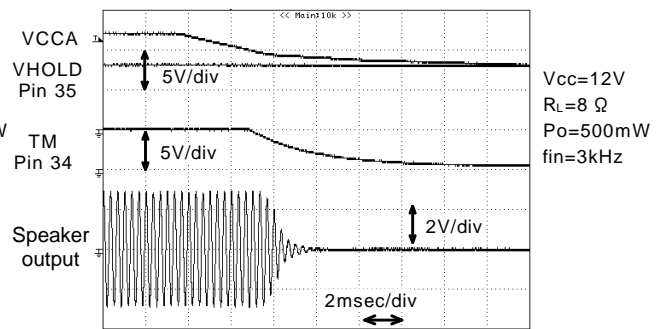

Fig. 16 Wave form on Instantaneous Power Interruption (2msec / div)

●Electrical characteristic curves (Reference data)

(2) Under Stereo Operation ($R_L=6\Omega$)

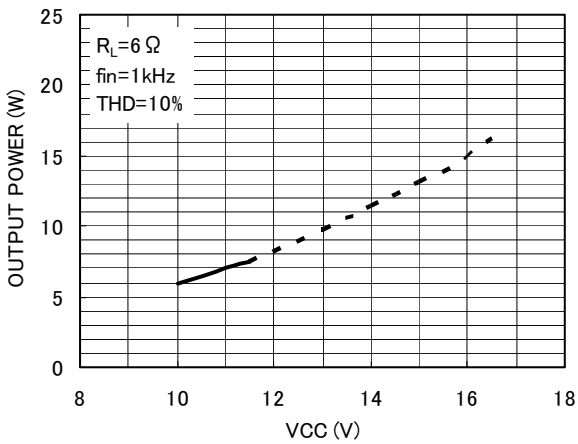

Fig. 17 Output power - Power supply voltage

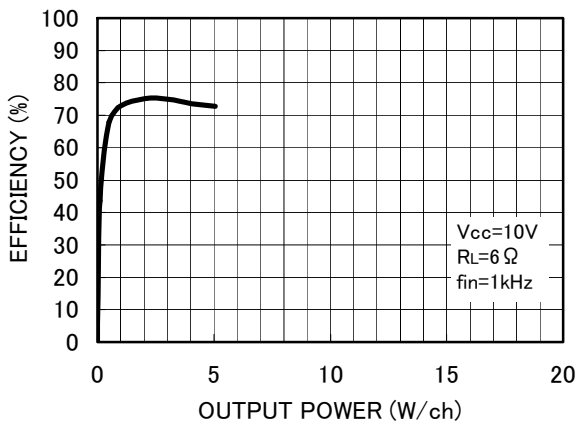

Fig. 18 Efficiency - Output power

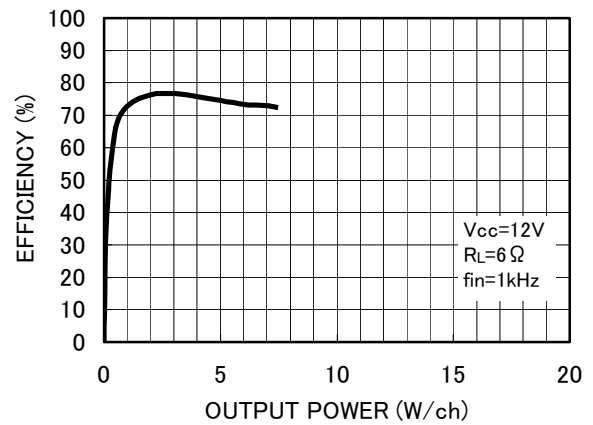

Fig. 19 Efficiency - Output power

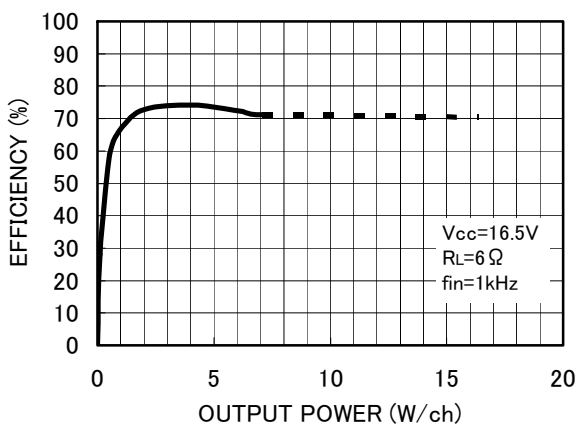

Fig. 20 Efficiency - Output power

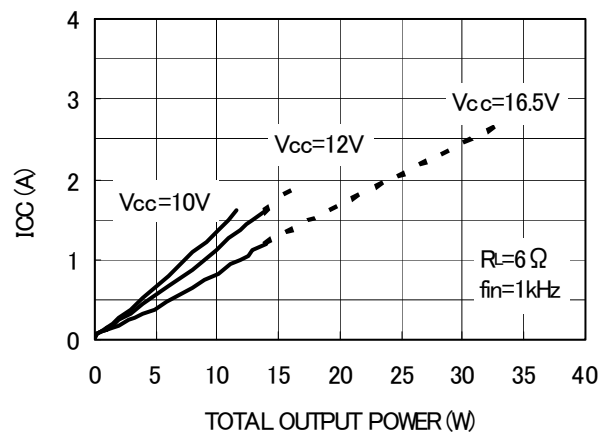

Fig. 21 Current consumption - Output power

Dotted lines of the graphs indicate continuous output power to be obtained on musical signal source or by installing additional heat sinks.

● Pin Assignment

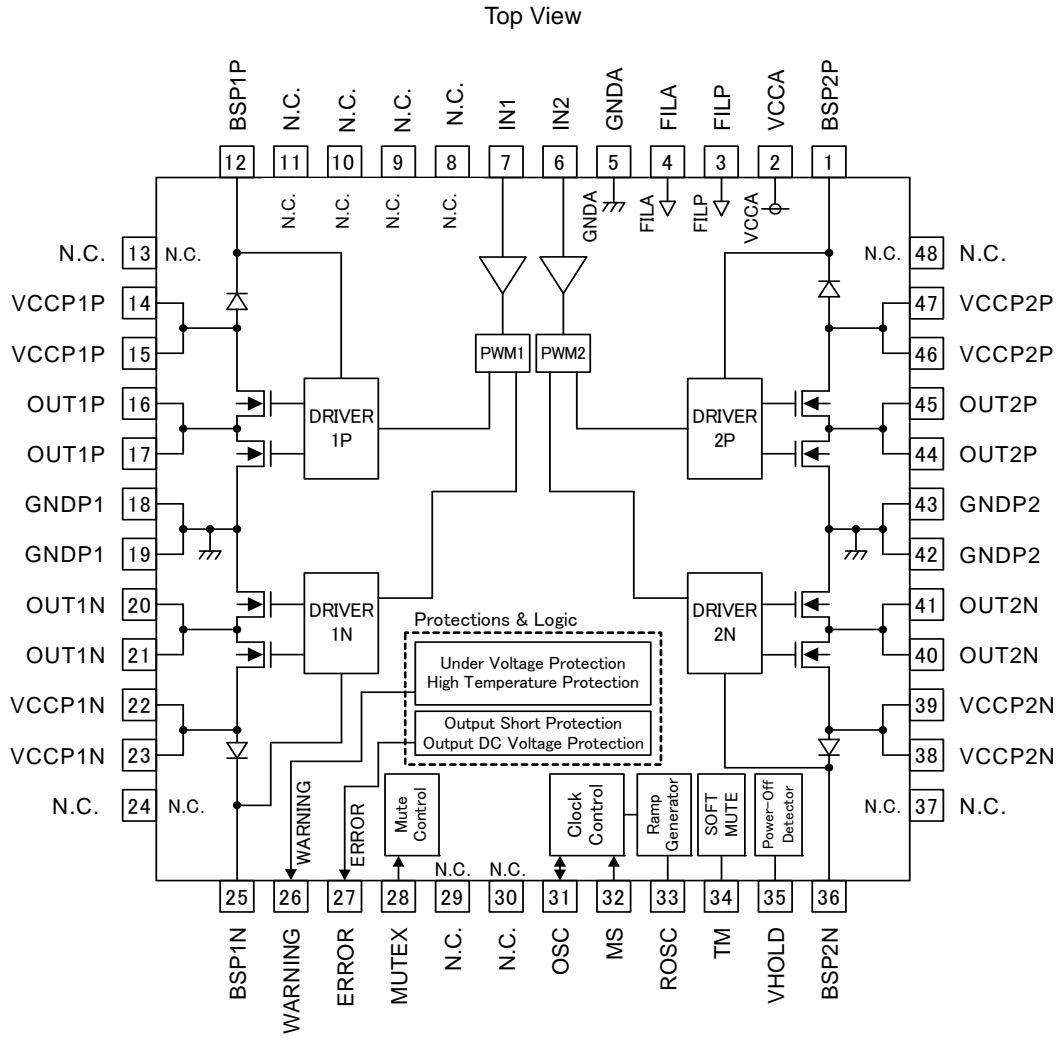

Fig. 22 Pin Assignment Diagram

● Outer Dimensions and Inscriptions

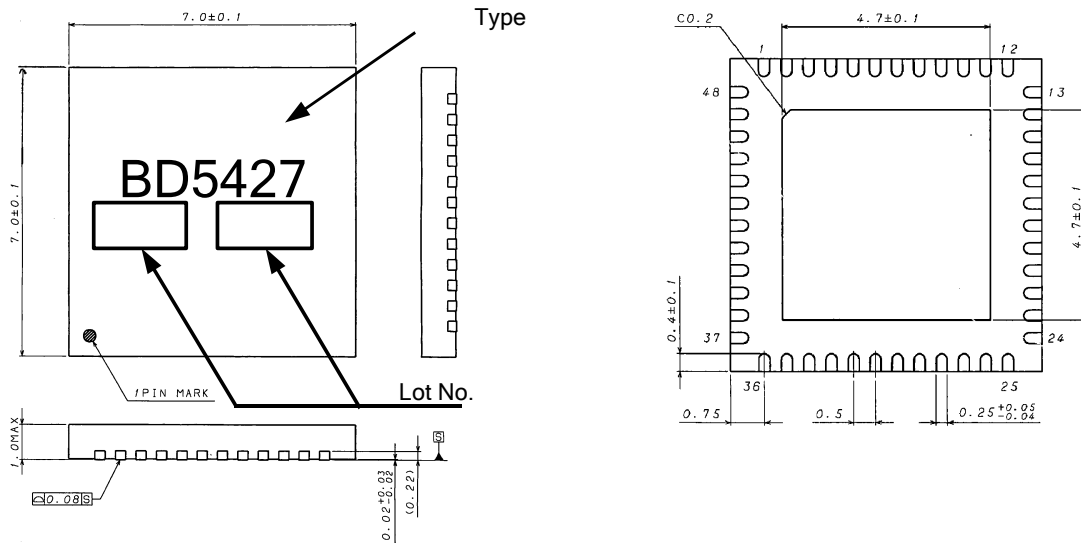

Fig. 23 Outer Dimensions and Inscriptions of VQFN048V7070 Package

●Explanation of Pin Functions (Provided pin voltages are typical values.)

No.	Symbol	Pin voltage	Pin description	Internal equalizing circuit
2	VCCA	Vcc	Analog system power pin	
3	FILP	$\frac{V_{cc}+3.5}{12}$	PWM system bias pin Connect a capacitor.	
4	FILA	3.5V	Analog signal system bias pin Connect a capacitor.	
5	GNDA	0V	Analog system GND pin	
6 7	IN2 IN1	3.5V	ch2 Analog signal input pin ch1 Analog signal input pin Input audio signal via a capacitor.	

●Explanation of Pin Functions - Continued

No.	Symbol	Pin voltage	Pin description	Internal equalizing circuit
12	BSP1P	-	ch1 positive bootstrap pin Connect a capacitor.	
14, 15	VCCP1P	V _{cc}	ch1 positive power system power supply pin	
16, 17	OUT1P	V _{cc} ~0V	ch1 positive PWM signal output pin Connect with output LPF.	
18, 19	GNDP1	0V	ch1 power system GND pin	
20, 21	OUT1N	V _{cc} ~0V	ch1 negative PWM signal output pin Connect with output LPF.	
22, 23	VCCP1N	V _{cc}	ch1 negative power system power supply pin	
25	BSP1N	-	ch1 negative bootstrap pin Connect a capacitor	
26	WARNING	H: 5V L: 0V	Warning output pin Pin to notify operation warning. H: Under warning L: Normal operation Connect a resistor.	
27	ERROR	H: 5V L: 0V	Error output pin A pin for notifying operation errors. H: Error L: Normal operation Connect a resistor.	

●Explanation of Pin Functions - Continued

No.	Symbol	Pin voltage	Pin description	Internal equalizing circuit
28	MUTEX	-	Audio mute control pin H: Mute off L: Mute on	
8, 9 10, 11 13, 24 29, 30 37, 48	N.C.	-	N.C. pin Nothing is connected with IC internal circuit.	
31	OSC	-	Sampling clock signal input/output pin When using two or more sampling clocks, connect via a capacitor.	
32	MS	-	Master/Slave switching pin Switching of master/slave functions on a sampling clock signal. H: Slave operation L: Master operation	
33	ROSC	5.6V	Internal PWM sampling clock frequency setting pin Usually the pin is used open. To adjust an internal sampling clock frequency, connect a resistor.	

●Explanation of Pin Functions - Continued

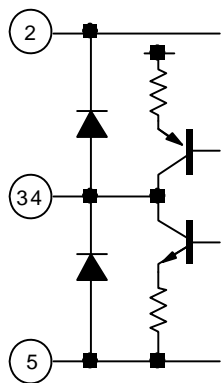
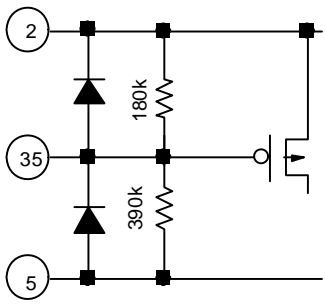
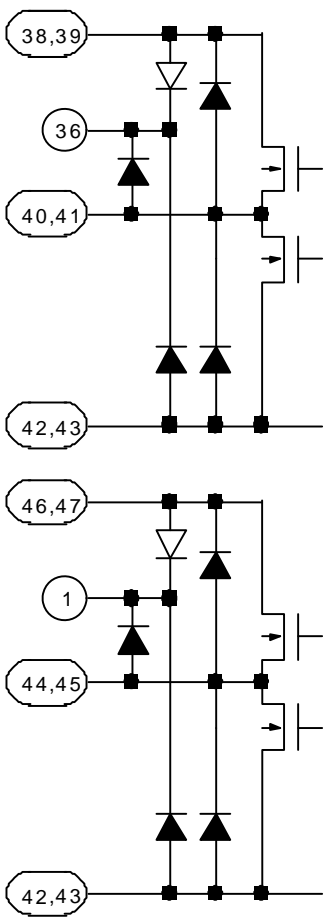
No.	Symbol	Pin voltage	Pin description	Internal equalizing circuit
34	TM	0~5V	Audio muting constant setting pin Connect a capacitor.	
35	VHOLD	0.68xVcc	Instantaneous power interruption detecting voltage setting pin Connect a capacitor. To adjust a detecting voltage, connect a resistor.	
36	BSP2N	-	ch2 negative bootstrap pin Connect a capacitor.	
38, 39	VCCP2N	Vcc	ch2 negative power system power supply pin	
40, 41	OUT2N	Vcc~0V	ch2 negative PWM signal output pin Connect an output LPF.	
42, 43	GNDP2	0V	cch2 power system GND pin	
44, 45	OUT2P	Vcc~0V	ch2 positive PWM signal output pin Connect an output LPF.	
46, 47	VCCP2P	Vcc	ch2 positive power system power supply pin	
1	BSP2P	-	ch2 positive bootstrap pin Connect a capacitor.	

● Application Circuit Diagram

• Vcc=10V~16.5V

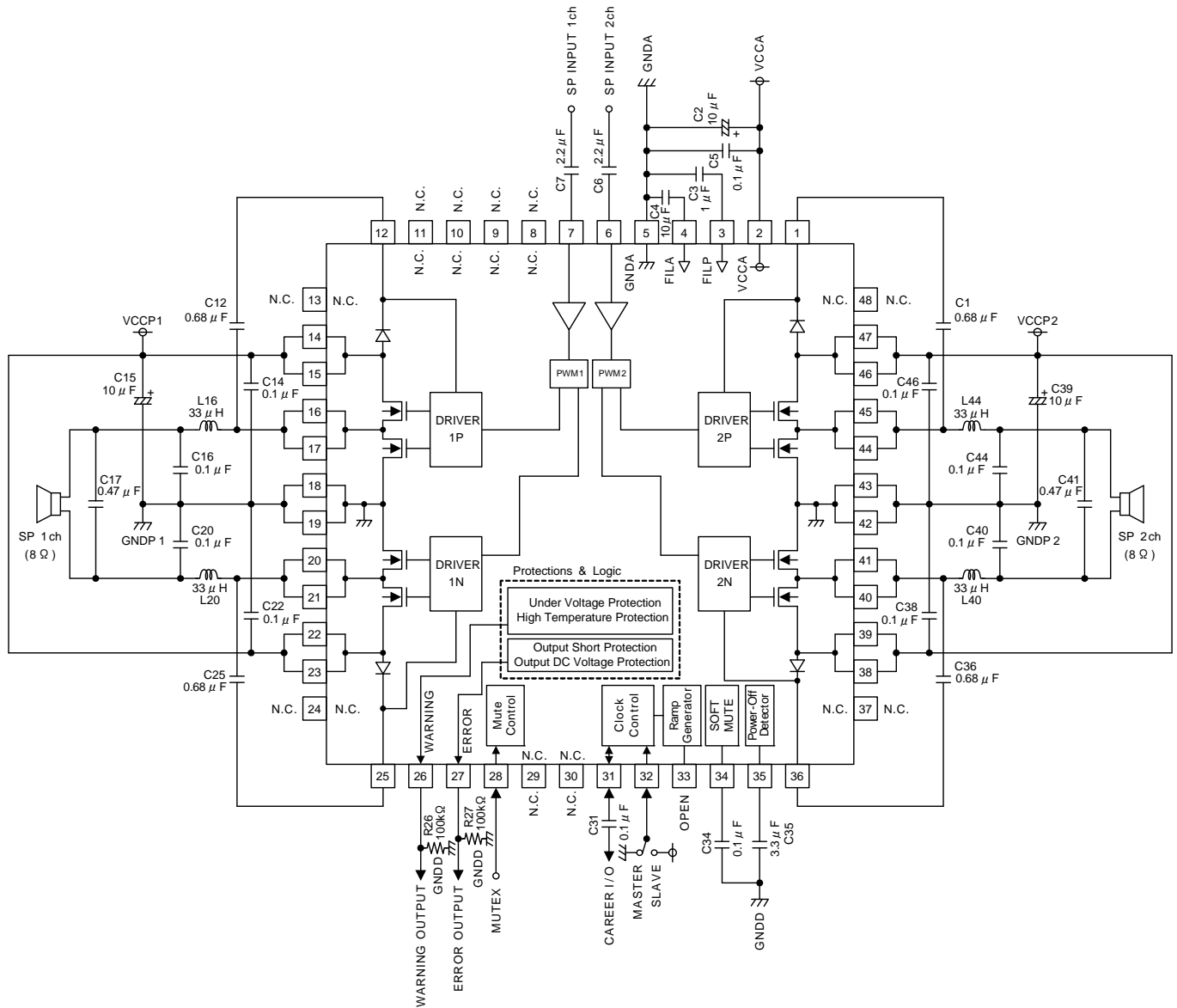

Fig. 24 Circuit Diagram of Stereo Operation with 8Ω Load

Table 1 BOM List of Stereo Operation with 8Ω Load

No.	Item	Part Number	Vendor	Configuration		Value	Rated voltage	Tolerance	Temperature characteristics	Quantity	Reference
				mm	inch						
1	IC	BD5427MUV	ROHM	VQFN048V7070		-	-	-	-	1	IC1
2	C	GRM219B31E684KA88	MURATA	2012	0805	0.68μF	25V	±10%	±10%	4	C1, C12, C25, C36
3	C	GRM188R11H104KA93	MURATA	1608	0603	0.1μF	50V	±15%	±15%	5	C5, C14, C22, C38, C46
4	C	GRM21BB11H104KA01	MURATA	2012	0805	0.1μF	50V	±10%	±10%	4	C16, C20, C40, C44
5	C	25ST225M3225	Rubycon	3225	1210	2.2μF	25V	±20%	±5%	2	C6, C7
6	C	50ST474M3225	Rubycon	3225	1210	0.47μF	50V	±20%	±5%	2	C17, C41
7	C	GRM21BB31E335KA75	MURATA	2012	0805	3.3μF	25V	±10%	±10%	1	C35
8	C	GRM188B11E104KA01	MURATA	1608	0603	0.1μF	25V	±10%	±10%	2	C31, C34
9	C	GRM21BB11C105KA01	MURATA	2012	0805	1μF	16V	±10%	±10%	1	C3
10	C	GRM21BB31C106KE15	MURATA	2012	0805	10μF	16V	±10%	±10%	1	C4
11	C	25SVPD10M	SANYO	6666	2626	10μF	25V	±20%	±25%	3	C2, C15, C39
12	R	MCR01MZPF1003	ROHM	1005	0402	100kΩ	50V	±1%	±200ppm/°C	2	R26, R27

No.	Item	Part Number	Vendor	Configuration	Value	Tolerance	DC Resistance	Rated DC Current	Quantity	Reference
				mm						
13	L	7G09B-330M	SAGAMI	10×9×10	33μH×2	±20%	52mΩmax.	2.0A max.	2	L16, L20, L40, L44

● Ordering part number

1. About absolute maximum ratings

If an applied voltage or an operating temperature exceeds an absolute maximum rating, it may cause destruction of a device. A result of destruction, whether it is short mode or open mode, is not predictable. Therefore, provide a physical safety measure such as fuse, against a special mode that may violate conditions of absolute maximum ratings.

2. About power supply line

As return of current regenerated by back EMF of output coil happens, take steps such as putting capacitor between power supply and GND as a electric pathway for the regenerated current. Be sure that there is no problem with each property such as emptied capacity at lower temperature regarding electrolytic capacitor to decide capacity value. If the connected power supply does not have sufficient current absorption capacity, regenerative current will cause the voltage on the power supply line to rise, which combined with the product and its peripheral circuitry may exceed the absolute maximum ratings. It is recommended to implement a physical safety measure such as the insertion of a voltage clamp diode between the power supply and GND pins.

3. Potential of GND (5, 18, 39, 42, and 43 pins)

Potential of the GND terminal must be the lowest under any operating conditions.

4. About thermal design

Perform thermal design with sufficient margins, in consideration of maximum power dissipation Pd under actual operating conditions. This product has an exposed frame on the back of the package, and it is assumed that the frame is used with measures to improve efficiency of heat dissipation. In addition to front surface of board, provide a heat dissipation pattern as widely as possible on the back also.

A class-D power amplifier has heat dissipation efficiency far higher than that of conventional analog power amplifier and generates less heat. However, extra attention must be paid in thermal design so that a power dissipation Pdiss should not exceed the maximum power dissipation Pd.

$$\text{Maximum power dissipation} \quad P_d = \frac{T_{j\max} - T_a}{\theta_{ja}} \quad [\text{W}]$$

$$\text{Power dissipation} \quad P_{\text{diss}} = P_o \left(\frac{1}{\eta} - 1 \right) \quad [\text{W}]$$

Tjmax: Maximum temperature junction = 150[°C]

Ta: Operating ambient temperature [°C]

θja: Package thermal resistance [°C/W]

Po: Output power [W]

η: Efficiency

5. About operations in strong electric field

Note that the device may malfunction in a strong electric field.

6. Thermal shutdown (TSD) circuit

This product is provided with a built-in thermal shutdown circuit. When the thermal shutdown circuit operates, the output transistors are placed under open status. The thermal shutdown circuit is primarily intended to shut down the IC avoiding thermal runaway under abnormal conditions with a chip temperature exceeding Tjmax = 150°C, and is not intended to protect and secure an electrical appliance. Accordingly, do not use this circuit function to protect a customer's electrical appliance.

7. About shorting between pins and installation failure

Be careful about direction and displacement of an LSI when installing it onto the board. Faulty installation may destroy the LSI when the device is energized. In addition, a foreign matter getting in between LSI pins, pins and power supply, and pins and GND may cause shorting and destruction of the LSI.

8. About power supply startup and shutdown

When starting up a power supply, be sure to place the MUTEX pin (pin 28) at "L" level. When shutting down a power supply also, be sure to place the pin at "L" level. Those processes reduce pop noises generated upon turning on and off the power supply. In addition, all power supply pins must be started up and shut down at the same time.

9. About WARNING output pin (pin 26) and ERROR output pin (pin 27)

A WARNING flag is output from the WARNING output pin upon operation of the high-temperature protection function and under-voltage protection function. And an ERROR flag is output from the ERROR output pin upon operation of VCC/GND shorting protection function and speaker DC voltage applying protection function. These flags are the function which the condition of this product is shown in. The use which aimed at the protection except for this product is prohibition.

10. About N.C. pins (pins 8, 9, 10, 11, 13, 24, 29, 30, 37, and 48)

The N.C. (Non connection) pins are not connected with an internal circuit. Leave the pins open or connect them to GND.

● Ordering part number

B	D
---	---

Part No
BD.

5	4	2	7
---	---	---	---

Part No.
5427

M	U	V
---	---	---

Package
MUV: VQFN048V7070

E	2
---	---

Packaging and forming specification
E2: Embossed tape and reel

VQFN048V7070

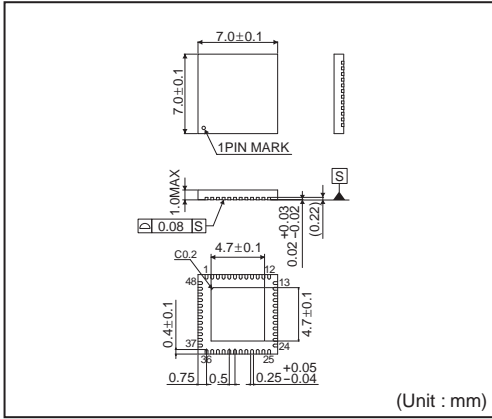

<Tape and Reel information>

Tape	Embossed carrier tape
Quantity	1500pcs
Direction of feed	E2 (The direction is the 1pin of product is at the upper left when you hold reel on the left hand and you pull out the tape on the right hand)

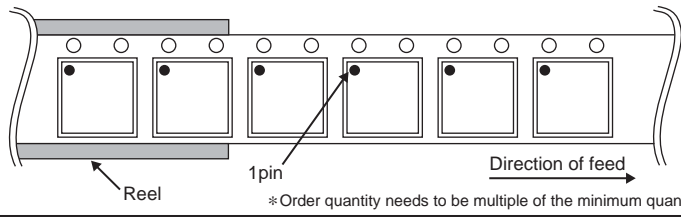

Notes

No copying or reproduction of this document, in part or in whole, is permitted without the consent of ROHM Co.,Ltd.

The content specified herein is subject to change for improvement without notice.

The content specified herein is for the purpose of introducing ROHM's products (hereinafter "Products"). If you wish to use any such Product, please be sure to refer to the specifications, which can be obtained from ROHM upon request.

Examples of application circuits, circuit constants and any other information contained herein illustrate the standard usage and operations of the Products. The peripheral conditions must be taken into account when designing circuits for mass production.

Great care was taken in ensuring the accuracy of the information specified in this document. However, should you incur any damage arising from any inaccuracy or misprint of such information, ROHM shall bear no responsibility for such damage.

The technical information specified herein is intended only to show the typical functions of and examples of application circuits for the Products. ROHM does not grant you, explicitly or implicitly, any license to use or exercise intellectual property or other rights held by ROHM and other parties. ROHM shall bear no responsibility whatsoever for any dispute arising from the use of such technical information.

The Products specified in this document are intended to be used with general-use electronic equipment or devices (such as audio visual equipment, office-automation equipment, communication devices, electronic appliances and amusement devices).

The Products specified in this document are not designed to be radiation tolerant.

While ROHM always makes efforts to enhance the quality and reliability of its Products, a Product may fail or malfunction for a variety of reasons.

Please be sure to implement in your equipment using the Products safety measures to guard against the possibility of physical injury, fire or any other damage caused in the event of the failure of any Product, such as derating, redundancy, fire control and fail-safe designs. ROHM shall bear no responsibility whatsoever for your use of any Product outside of the prescribed scope or not in accordance with the instruction manual.

The Products are not designed or manufactured to be used with any equipment, device or system which requires an extremely high level of reliability the failure or malfunction of which may result in a direct threat to human life or create a risk of human injury (such as a medical instrument, transportation equipment, aerospace machinery, nuclear-reactor controller, fuel-controller or other safety device). ROHM shall bear no responsibility in any way for use of any of the Products for the above special purposes. If a Product is intended to be used for any such special purpose, please contact a ROHM sales representative before purchasing.

If you intend to export or ship overseas any Product or technology specified herein that may be controlled under the Foreign Exchange and the Foreign Trade Law, you will be required to obtain a license or permit under the Law.



Thank you for your accessing to ROHM product informations.
More detail product informations and catalogs are available, please contact us.

ROHM Customer Support System

<http://www.rohm.com/contact/>