

# BFG25A/X

NPN 5 GHz wideband transistor

Rev. 04 — 27 November 2007

Product data sheet

## IMPORTANT NOTICE

Dear customer,

As from October 1st, 2006 Philips Semiconductors has a new trade name - NXP Semiconductors, which will be used in future data sheets together with new contact details.

In data sheets where the previous Philips references remain, please use the new links as shown below.

<http://www.philips.semiconductors.com> use <http://www.nxp.com>

<http://www.semiconductors.philips.com> use <http://www.nxp.com> (Internet)

[sales.addresses@www.semiconductors.philips.com](mailto:sales.addresses@www.semiconductors.philips.com) use [salesaddresses@nxp.com](mailto:salesaddresses@nxp.com) (email)

The copyright notice at the bottom of each page (or elsewhere in the document, depending on the version)

- © Koninklijke Philips Electronics N.V. (year). All rights reserved -

is replaced with:

- © NXP B.V. (year). All rights reserved. -

If you have any questions related to the data sheet, please contact our nearest sales office via e-mail or phone (details via [salesaddresses@nxp.com](mailto:salesaddresses@nxp.com)). Thank you for your cooperation and understanding,

NXP Semiconductors

# NPN 5 GHz wideband transistor

# BFG25A/X

### FEATURES

- Low current consumption (100  $\mu$ A to 1 mA)
- Low noise figure
- Gold metallization ensures excellent reliability.

### APPLICATIONS

- RF low power amplifiers, such as pocket telephones, paging systems, with signal frequencies up to 2 GHz.

### DESCRIPTION

NPN silicon wideband transistor in a four-lead dual emitter SOT143B plastic package (cross emitter).

### PINNING

PIN	DESCRIPTION
1	collector
2	emitter
3	base
4	emitter

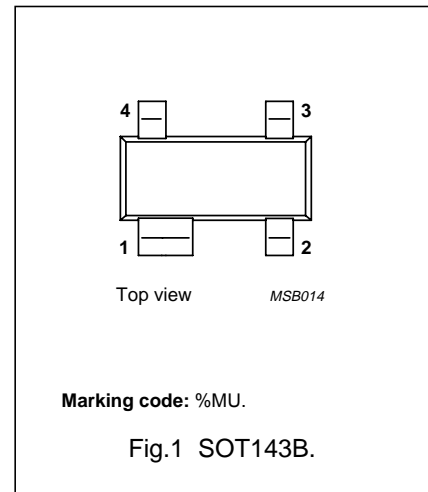

### QUICK REFERENCE DATA

SYMBOL	PARAMETER	CONDITIONS	MIN.	TYP.	MAX.	UNIT
$V_{CBO}$	collector-base voltage		–	–	8	V
$V_{CEO}$	collector-emitter voltage		–	–	5	V
$I_C$	collector current (DC)		–	–	6.5	mA
$P_{tot}$	total power dissipation	$T_s \leq 165\text{ }^\circ\text{C}$	–	–	32	mW
$h_{FE}$	DC current gain	$I_C = 0.5\text{ mA}; V_{CE} = 1\text{ V}$	50	80	200	
$f_T$	transition frequency	$I_C = 1\text{ mA}; V_{CE} = 1\text{ V}; f = 500\text{ MHz}; T_{amb} = 25\text{ }^\circ\text{C}$	3.5	5	–	GHz
$G_{UM}$	maximum unilateral power gain	$I_C = 0.5\text{ mA}; V_{CE} = 1\text{ V}; f = 1\text{ GHz}; T_{amb} = 25\text{ }^\circ\text{C}$	–	18	–	dB
F	noise figure	$I_C = 0.5\text{ mA}; V_{CE} = 1\text{ V}; f = 1\text{ GHz}; \Gamma = \Gamma_{opt}; T_{amb} = 25\text{ }^\circ\text{C}$	–	1.8	–	dB
		$I_C = 1\text{ mA}; V_{CE} = 1\text{ V}; f = 1\text{ GHz}; \Gamma = \Gamma_{opt}; T_{amb} = 25\text{ }^\circ\text{C}$	–	2	–	dB

## NPN 5 GHz wideband transistor

## BFG25A/X

**LIMITING VALUES**

In accordance with the Absolute Maximum Rating System (IEC 134).

SYMBOL	PARAMETER	CONDITIONS	MIN.	MAX.	UNIT
V <sub>CBO</sub>	collector-base voltage	open emitter	–	8	V
V <sub>CEO</sub>	collector-emitter voltage	open base	–	5	V
V <sub>EBO</sub>	emitter-base voltage	open collector	–	2	V
I <sub>C</sub>	collector current (DC)		–	6.5	mA
P <sub>tot</sub>	total power dissipation	T <sub>s</sub> ≤ 165 °C; note 1	–	32	mW
T <sub>stg</sub>	storage temperature		–65	150	°C
T <sub>j</sub>	junction temperature		–	175	°C

**Note**

1. T<sub>s</sub> is the temperature at the soldering point of the collector pin.

**THERMAL CHARACTERISTICS**

SYMBOL	PARAMETER	CONDITIONS	VALUE	UNIT
R <sub>th j-s</sub>	thermal resistance from junction to soldering point	note 1	320	K/W

**Note**

1. T<sub>s</sub> is the temperature at the soldering point of the collector pin.

**CHARACTERISTICS**

T<sub>j</sub> = 25 °C unless otherwise specified.

SYMBOL	PARAMETER	CONDITIONS	MIN.	TYP.	MAX.	UNIT
I <sub>CBO</sub>	collector leakage current	I <sub>E</sub> = 0; V <sub>CB</sub> = 5 V	–	–	50	μA
h <sub>FE</sub>	DC current gain	I <sub>C</sub> = 0.5 mA; V <sub>CE</sub> = 1 V	50	80	200	
C <sub>re</sub>	feedback capacitance	I <sub>C</sub> = i <sub>c</sub> = 0; V <sub>CB</sub> = 1 V; f = 1 MHz	–	0.21	0.3	pF
f <sub>T</sub>	transition frequency	I <sub>C</sub> = 1 mA; V <sub>CE</sub> = 1 V; T <sub>amb</sub> = 25 °C; f = 500 MHz	3.5	5	–	GHz
G <sub>UM</sub>	maximum unilateral power gain (note 1)	I <sub>C</sub> = 0.5 mA; V <sub>CE</sub> = 1 V; f = 1 GHz; T <sub>amb</sub> = 25 °C	–	18	–	dB
F	noise figure	I <sub>C</sub> = 0.5 mA; V <sub>CE</sub> = 1 V; f = 1 GHz; Γ = Γ <sub>opt</sub> ; T <sub>amb</sub> = 25 °C	–	1.8	–	dB
		I <sub>C</sub> = 1 mA; V <sub>CE</sub> = 1 V; f = 1 GHz; Γ = Γ <sub>opt</sub> ; T <sub>amb</sub> = 25 °C	–	2	–	dB

**Note**

1. G<sub>UM</sub> is the maximum unilateral power gain, assuming S<sub>12</sub> is zero and  $G_{UM} = 10 \log \frac{|S_{21}|^2}{(1 - |S_{11}|^2)(1 - |S_{22}|^2)}$  dB

NPN 5 GHz wideband transistor

BFG25A/X

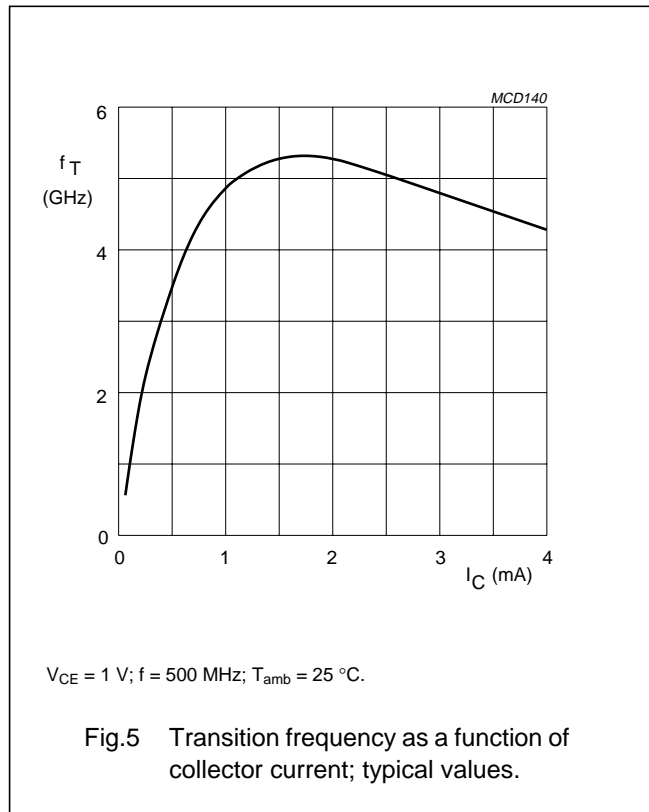
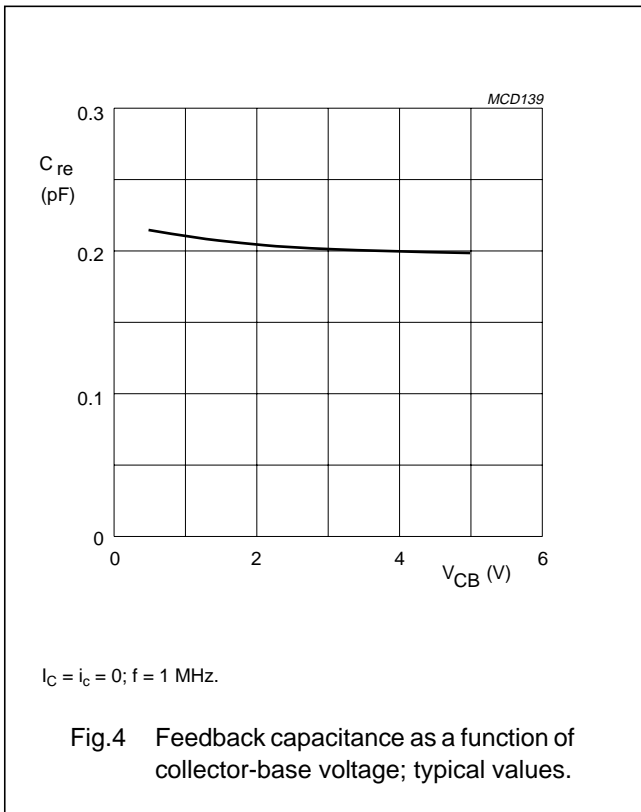
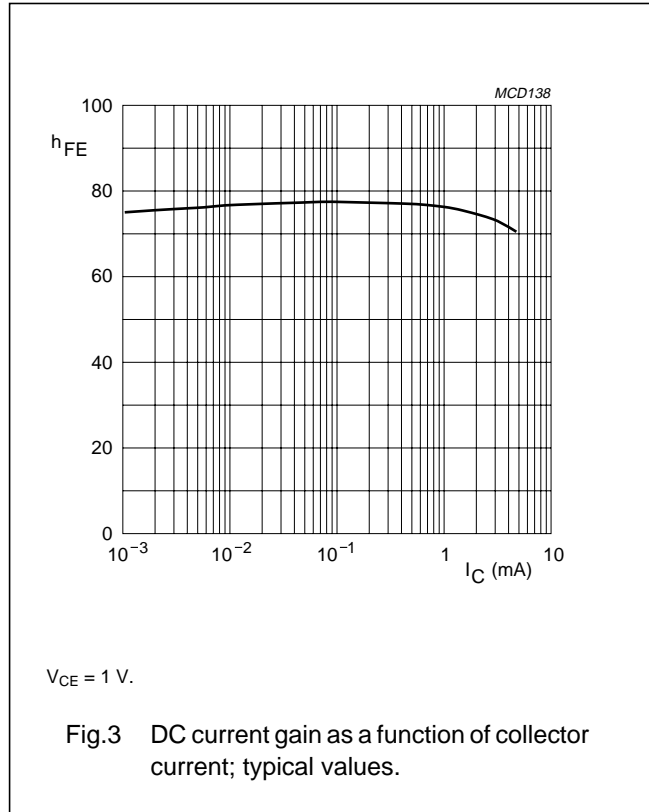
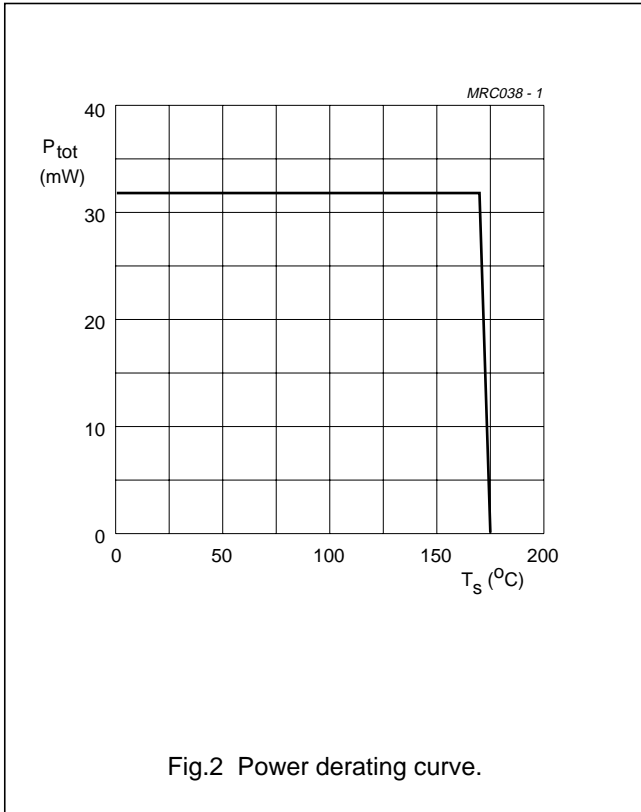

NPN 5 GHz wideband transistor

BFG25A/X

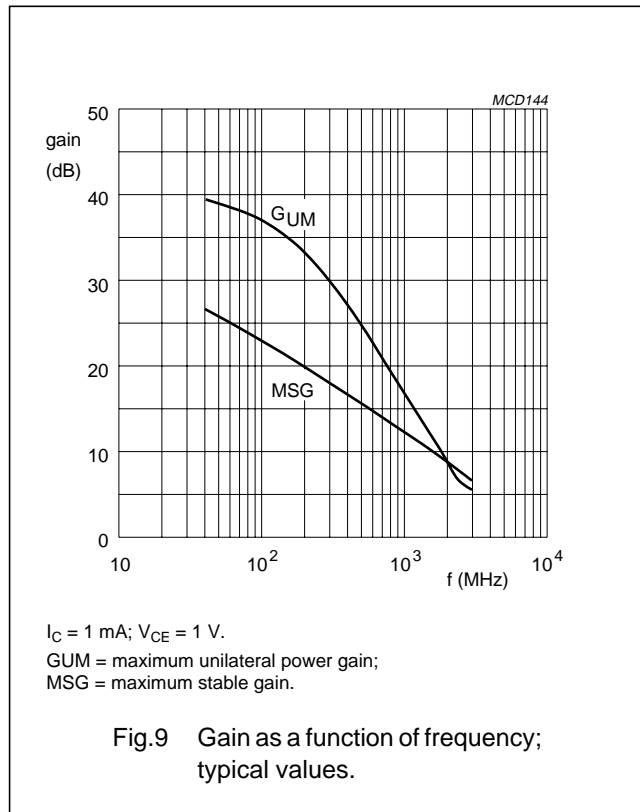
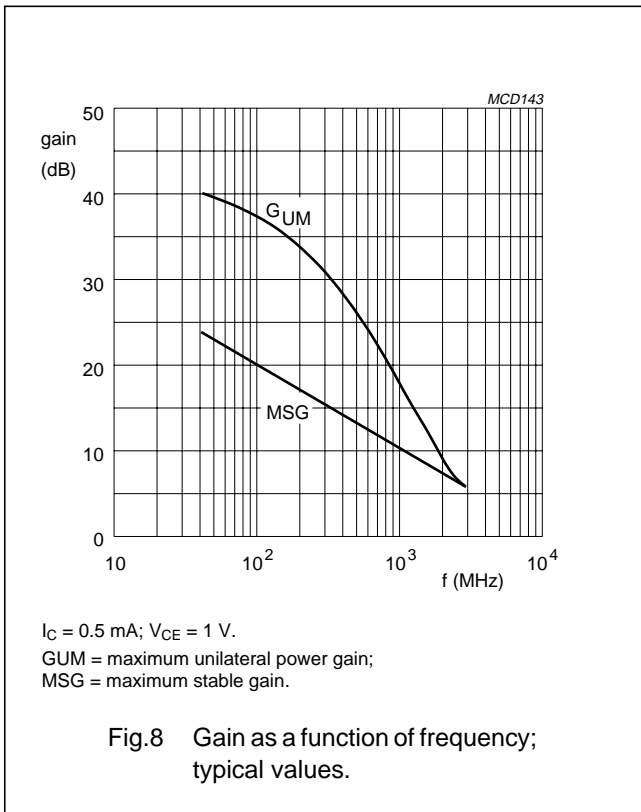
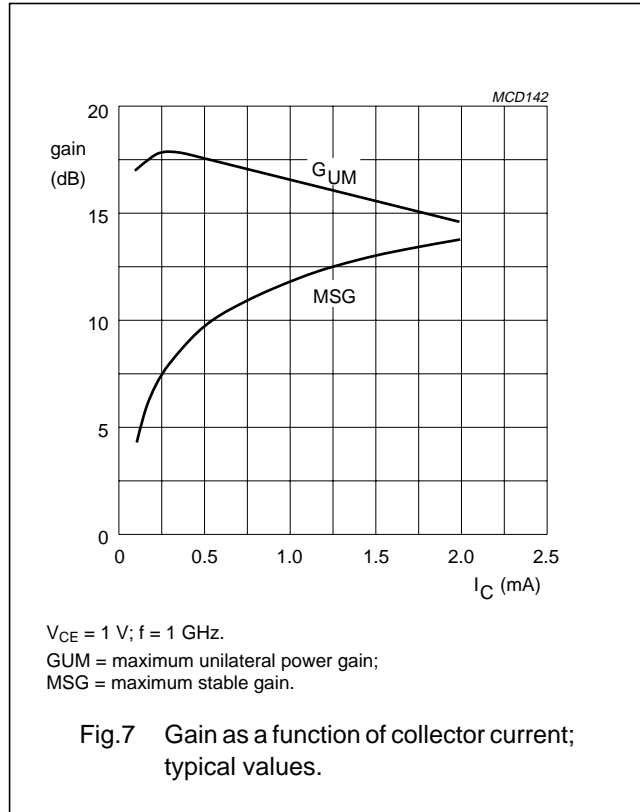
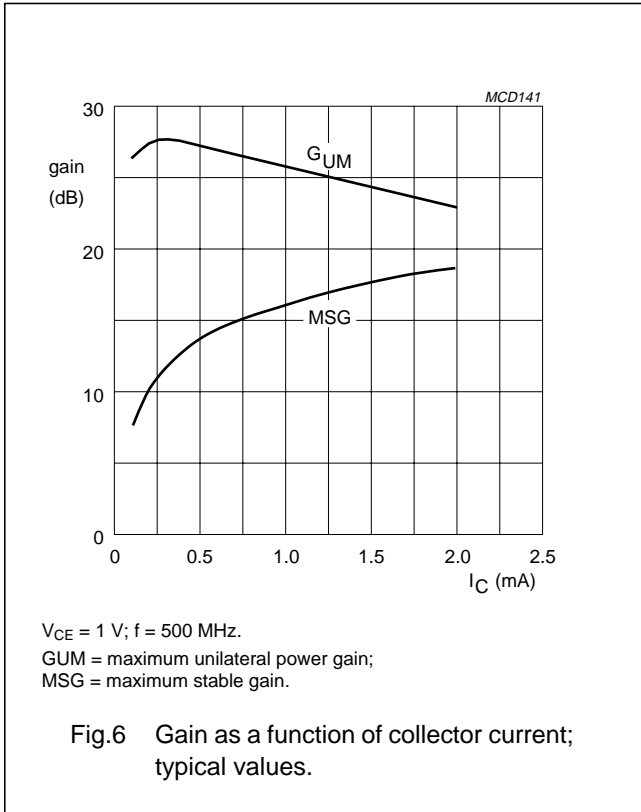

NPN 5 GHz wideband transistor

BFG25A/X

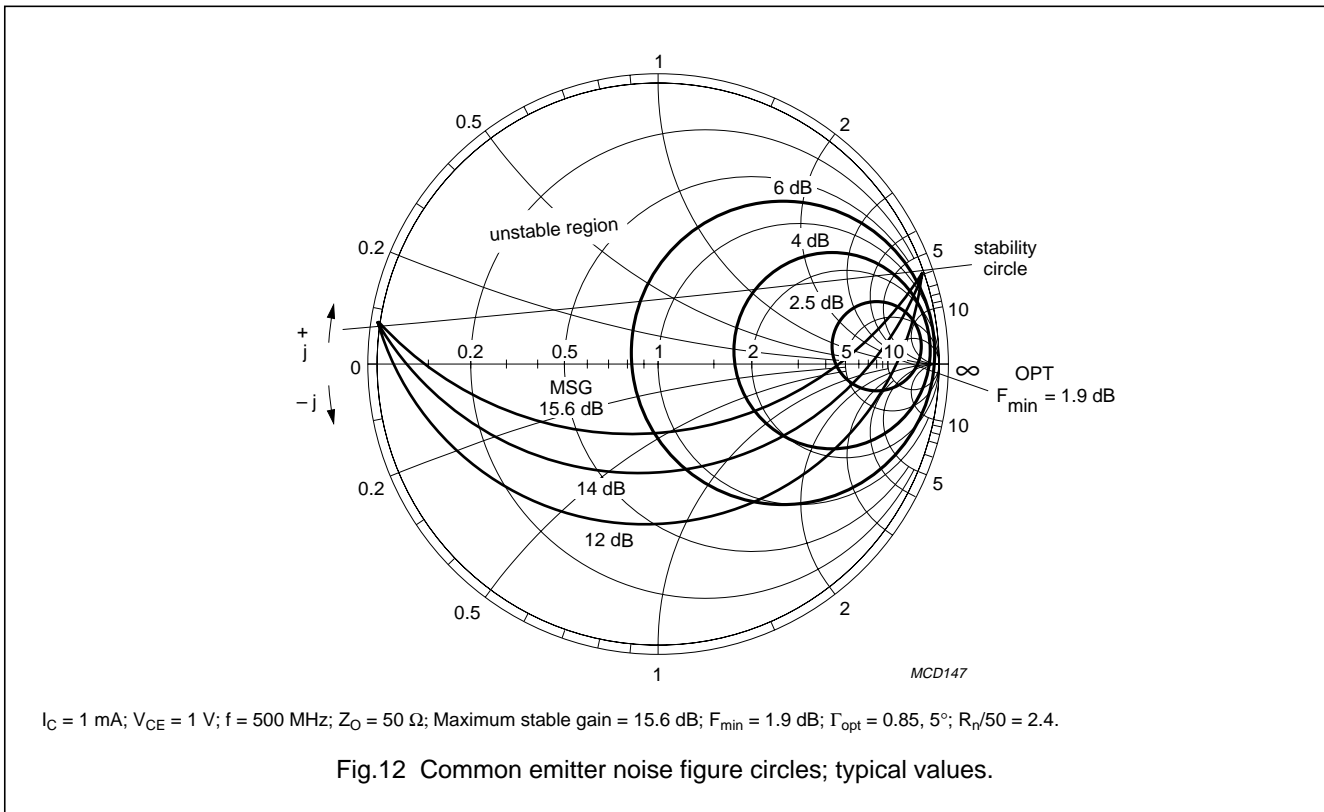
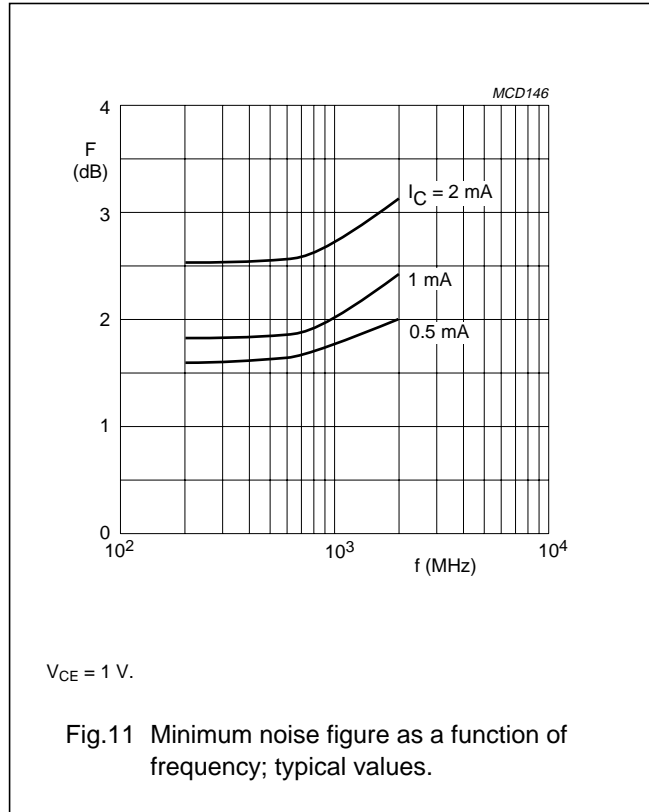
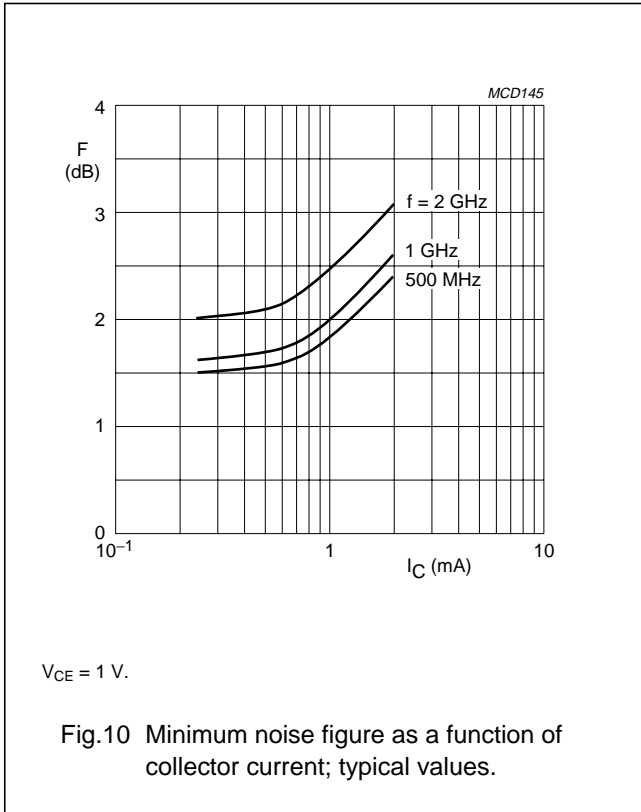

NPN 5 GHz wideband transistor

BFG25A/X

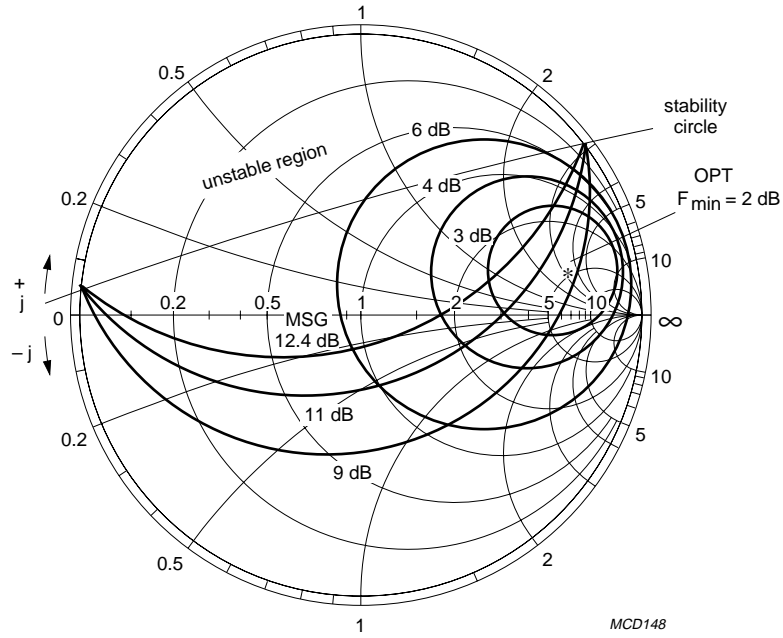

$I_C = 1$  mA;  $V_{CE} = 1$  V;  $f = 1000$  MHz;  $Z_O = 50 \Omega$ ; Maximum stable gain = 12.4 dB;  $F_{min} = 2$  dB;  $\Gamma_{opt} = 0.78, 14^\circ$ ;  $R_n/50 = 2.6$ .

Fig.13 Common emitter noise figure circles; typical values.

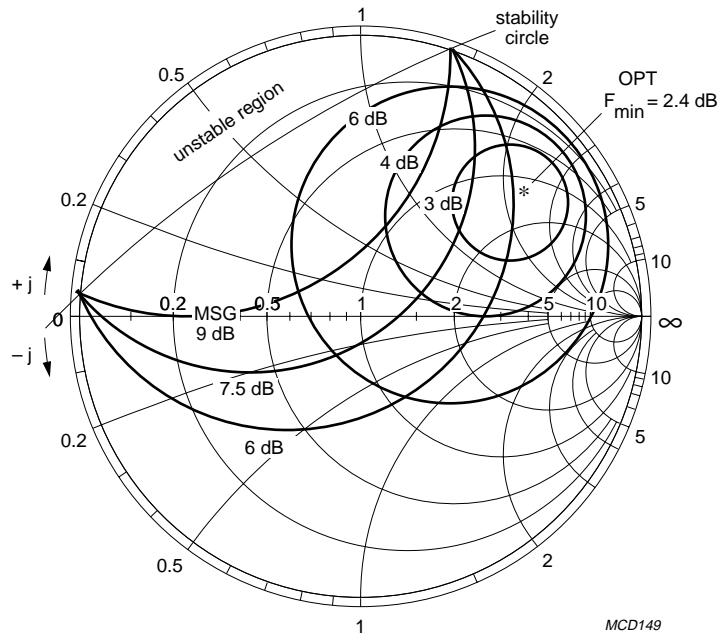

$I_C = 1$  mA;  $V_{CE} = 1$  V;  $f = 2000$  MHz;  $Z_O = 50 \Omega$ ; Maximum stable gain = 8.9 dB;  $F_{min} = 2.4$  dB;  $\Gamma_{opt} = 0.72, 38^\circ$ ;  $R_n/50 = 1.9$ .

Fig.14 Common emitter noise figure circles; typical values.

NPN 5 GHz wideband transistor

BFG25A/X

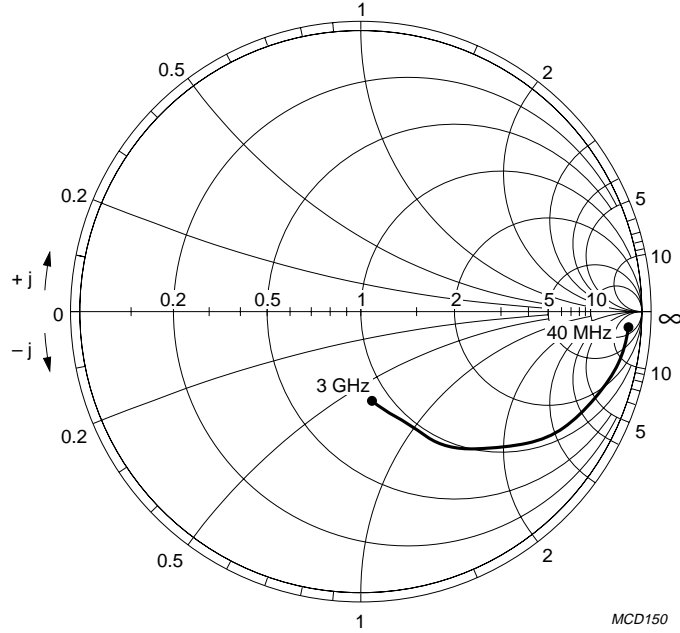

$I_C = 1 \text{ mA}$ ;  $V_{CE} = 1 \text{ V}$ ;  $Z_0 = 50 \Omega$ .

Fig.15 Common emitter input reflection coefficient ( $S_{11}$ ); typical values.

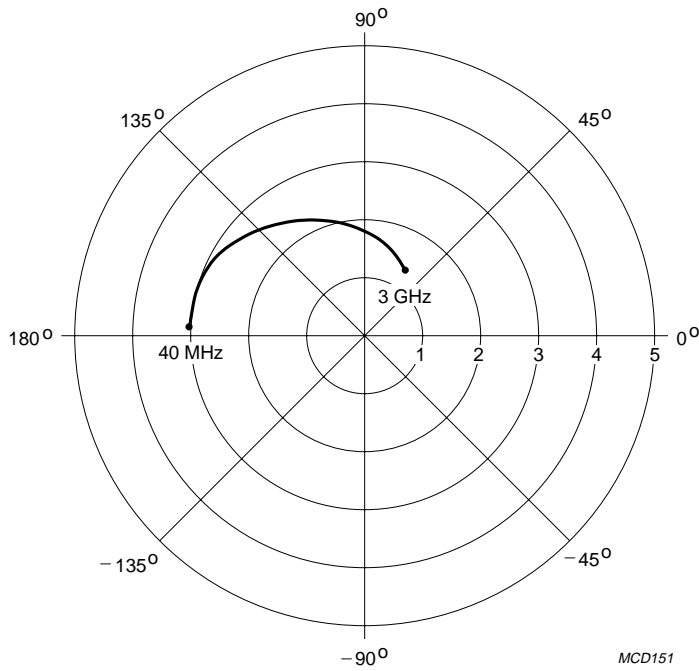

$I_C = 1 \text{ mA}$ ;  $V_{CE} = 1 \text{ V}$ .

Fig.16 Common emitter forward transmission coefficient ( $S_{21}$ ); typical values.



NPN 5 GHz wideband transistor

BFG25A/X

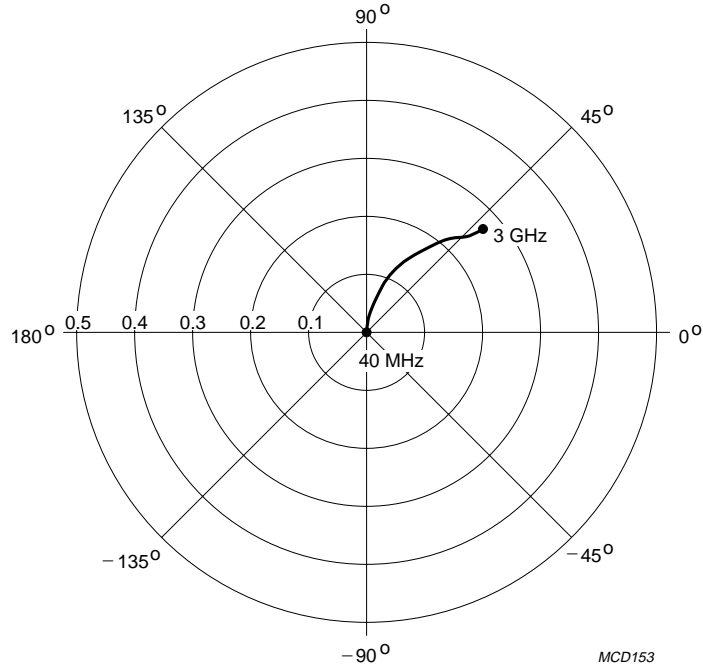

Fig.17 Common emitter reverse transmission coefficient ( $S_{12}$ ); typical values.

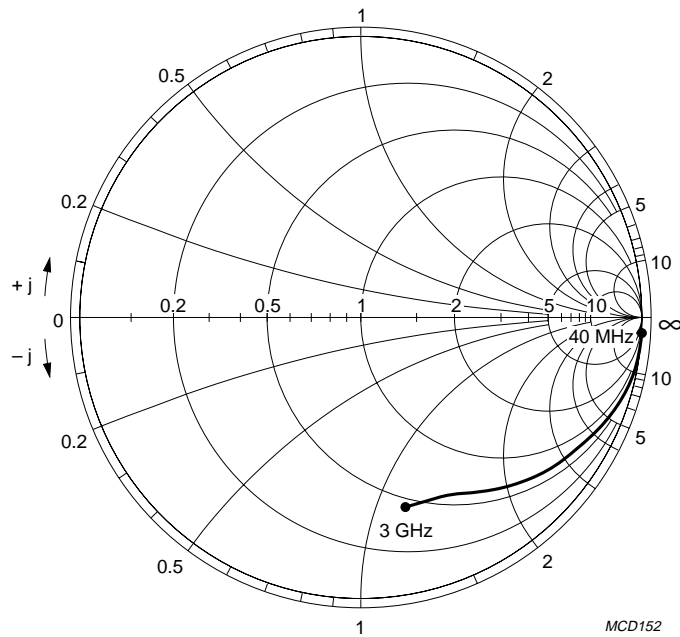

Fig.18 Common emitter output reflection coefficient ( $S_{22}$ ); typical values.

NPN 5 GHz wideband transistor

BFG25A/X

PACKAGE OUTLINE

Plastic surface mounted package; 4 leads

SOT143B

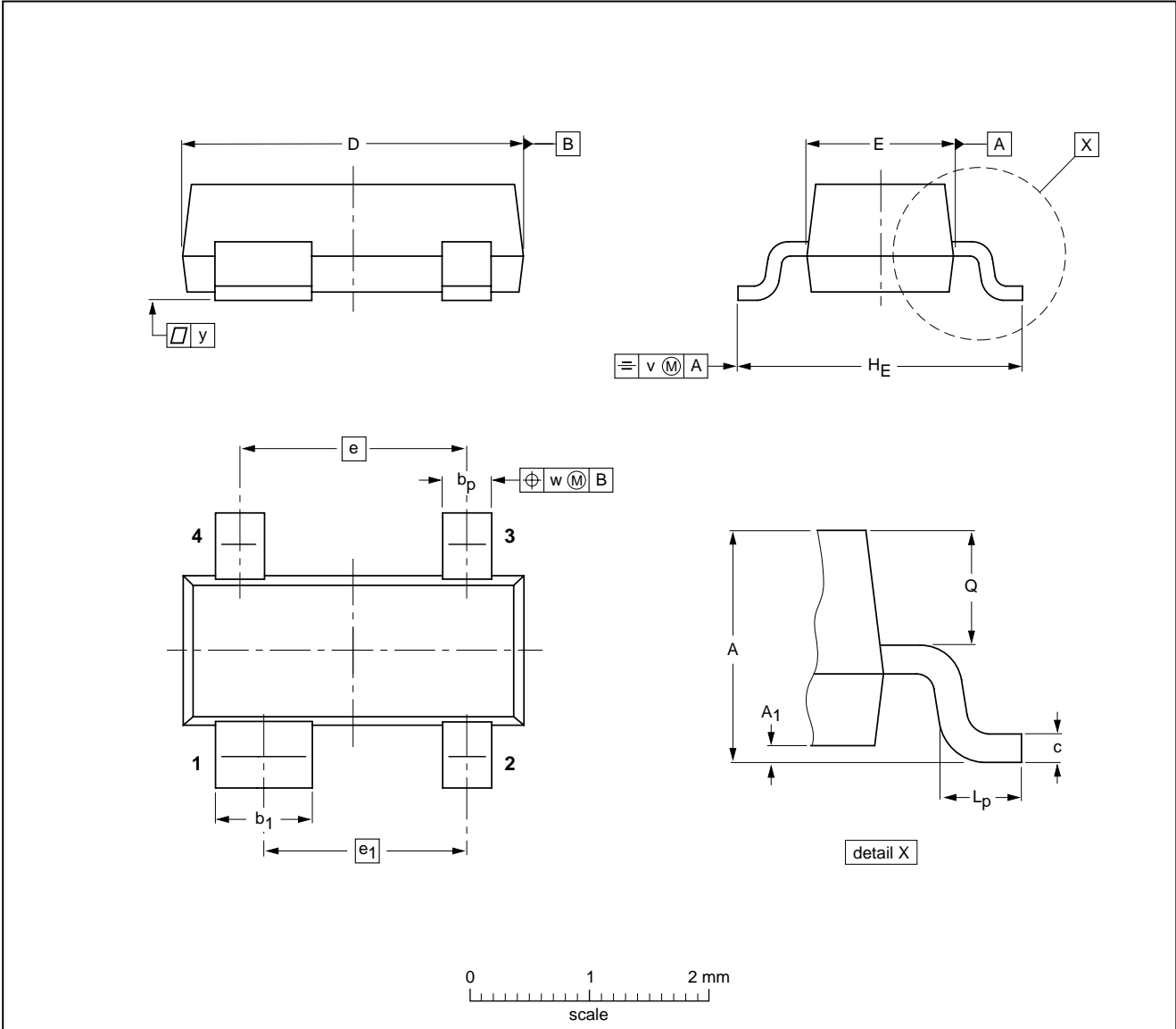

DIMENSIONS (mm are the original dimensions)

UNIT	A	A <sub>1</sub> max	b <sub>p</sub>	b <sub>1</sub>	c	D	E	e	e <sub>1</sub>	H <sub>E</sub>	L <sub>p</sub>	Q	v	w	y
mm	1.1 0.9	0.1	0.48 0.38	0.88 0.78	0.15 0.09	3.0 2.8	1.4 1.2	1.9	1.7	2.5 2.1	0.45 0.15	0.55 0.45	0.2	0.1	0.1

OUTLINE VERSION	REFERENCES				EUROPEAN PROJECTION	ISSUE DATE
	IEC	JEDEC	EIAJ			
SOT143B						97-02-28

## Legal information

### Data sheet status

Document status <sup>[1][2]</sup>	Product status <sup>[3]</sup>	Definition
Objective [short] data sheet	Development	This document contains data from the objective specification for product development.
Preliminary [short] data sheet	Qualification	This document contains data from the preliminary specification.
Product [short] data sheet	Production	This document contains the product specification.

[1] Please consult the most recently issued document before initiating or completing a design.

[2] The term 'short data sheet' is explained in section "Definitions".

[3] The product status of device(s) described in this document may have changed since this document was published and may differ in case of multiple devices. The latest product status information is available on the Internet at URL <http://www.nxp.com>.

### Definitions

**Draft** — The document is a draft version only. The content is still under internal review and subject to formal approval, which may result in modifications or additions. NXP Semiconductors does not give any representations or warranties as to the accuracy or completeness of information included herein and shall have no liability for the consequences of use of such information.

**Short data sheet** — A short data sheet is an extract from a full data sheet with the same product type number(s) and title. A short data sheet is intended for quick reference only and should not be relied upon to contain detailed and full information. For detailed and full information see the relevant full data sheet, which is available on request via the local NXP Semiconductors sales office. In case of any inconsistency or conflict with the short data sheet, the full data sheet shall prevail.

### Disclaimers

**General** — Information in this document is believed to be accurate and reliable. However, NXP Semiconductors does not give any representations or warranties, expressed or implied, as to the accuracy or completeness of such information and shall have no liability for the consequences of use of such information.

**Right to make changes** — NXP Semiconductors reserves the right to make changes to information published in this document, including without limitation specifications and product descriptions, at any time and without notice. This document supersedes and replaces all information supplied prior to the publication hereof.

**Suitability for use** — NXP Semiconductors products are not designed, authorized or warranted to be suitable for use in medical, military, aircraft, space or life support equipment, nor in applications where failure or

malfunction of an NXP Semiconductors product can reasonably be expected to result in personal injury, death or severe property or environmental damage. NXP Semiconductors accepts no liability for inclusion and/or use of NXP Semiconductors products in such equipment or applications and therefore such inclusion and/or use is at the customer's own risk.

**Applications** — Applications that are described herein for any of these products are for illustrative purposes only. NXP Semiconductors makes no representation or warranty that such applications will be suitable for the specified use without further testing or modification.

**Limiting values** — Stress above one or more limiting values (as defined in the Absolute Maximum Ratings System of IEC 60134) may cause permanent damage to the device. Limiting values are stress ratings only and operation of the device at these or any other conditions above those given in the Characteristics sections of this document is not implied. Exposure to limiting values for extended periods may affect device reliability.

**Terms and conditions of sale** — NXP Semiconductors products are sold subject to the general terms and conditions of commercial sale, as published at <http://www.nxp.com/profile/terms>, including those pertaining to warranty, intellectual property rights infringement and limitation of liability, unless explicitly otherwise agreed to in writing by NXP Semiconductors. In case of any inconsistency or conflict between information in this document and such terms and conditions, the latter will prevail.

**No offer to sell or license** — Nothing in this document may be interpreted or construed as an offer to sell products that is open for acceptance or the grant, conveyance or implication of any license under any copyrights, patents or other industrial or intellectual property rights.

### Trademarks

Notice: All referenced brands, product names, service names and trademarks are the property of their respective owners.

## Contact information

For additional information, please visit: <http://www.nxp.com>

For sales office addresses, send an email to: [salesaddresses@nxp.com](mailto:salesaddresses@nxp.com)

## Revision history

### Revision history

Document ID	Release date	Data sheet status	Change notice	Supersedes
BFG25AX_N_4	20071127	Product data sheet	-	BFG25AX_3
Modifications:	• Fig. 1 on page 2; Figure note changed			
BFG25AX_3 (9397 750 02767)	19971029	Product specification	-	BFG25AX_2
BFG25AX_2	19950901	Product specification	-	BFG25AX_1
BFG25AX_1	19921101	Product specification	-	-

Please be aware that important notices concerning this document and the product(s) described herein, have been included in section 'Legal information'.

founded by

**PHILIPS**

© NXP B.V. 2007.

All rights reserved.

For more information, please visit: <http://www.nxp.com>

For sales office addresses, please send an email to: [salesaddresses@nxp.com](mailto:salesaddresses@nxp.com)

Date of release: 27 November 2007

Document identifier: BFG25AX\_N\_4