

NPN Silicon High-Voltage Transistor

BFN 20

- Suitable for video output stages in TV sets and switching power supplies
- High breakdown voltage
- Low collector-emitter saturation voltage
- Low capacitance
- Complementary type: BFN 21 (PNP)

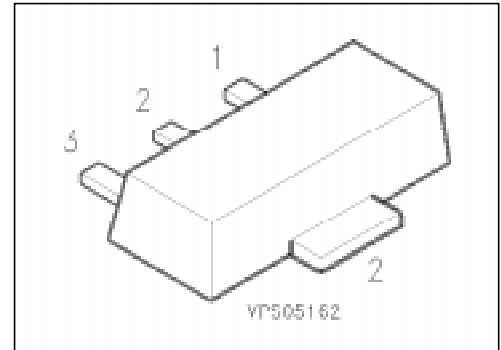

Type	Marking	Ordering Code (tape and reel)	Pin Configuration			Package ¹⁾
			1	2	3	
BFN 20	DC	Q62702-F1058	B	C	E	SOT-89

Maximum Ratings

Parameter	Symbol	Values	Unit
Collector-emitter voltage	V_{CE0}	300	V
Collector-base voltage	V_{CB0}	300	
Collector-emitter voltage, $R_{BE} = 2.7 \text{ k}\Omega$	V_{CER}	300	
Emitter-base voltage	V_{EB0}	5	
Collector current	I_C	50	mA
Peak collector current	I_{CM}	100	
Total power dissipation, $T_S = 120 \text{ }^\circ\text{C}$	P_{tot}	1	W
Junction temperature	T_j	150	$^\circ\text{C}$
Storage temperature range	T_{stg}	- 65 ... + 150	

Thermal Resistance

Junction - ambient ²⁾	$R_{th \text{ JA}}$	≤ 90	K/W
Junction - soldering point	$R_{th \text{ JS}}$	≤ 30	

¹⁾ For detailed information see chapter Package Outlines.

²⁾ Package mounted on epoxy pcb 40 mm × 40 mm × 1.5 mm/6 cm² Cu.

Electrical Characteristics

at $T_A = 25\text{ °C}$, unless otherwise specified.

Parameter	Symbol	Values			Unit
		min.	typ.	max.	

DC characteristics

Collector-emitter breakdown voltage $I_C = 1\text{ mA}$	$V_{(BR)CE0}$	300	–	–	V
Collector-base breakdown voltage $I_C = 10\text{ }\mu\text{A}$	$V_{(BR)CB0}$	300	–	–	
Collector-emitter breakdown voltage $I_C = 10\text{ }\mu\text{A}$, $R_{BE} = 2.7\text{ k}\Omega$	$V_{(BR)CER}$	300	–	–	
Emitter-base breakdown voltage $I_E = 10\text{ }\mu\text{A}$	$V_{(BR)EB0}$	5	–	–	
Collector-base cutoff current $V_{CB} = 250\text{ V}$ $V_{CB} = 250\text{ V}$, $T_A = 150\text{ °C}$	I_{CB0}	– –	– –	100 20	nA μA
Collector cutoff current $V_{CE} = 300\text{ V}$, $R_{BE} = 2.7\text{ k}\Omega$ $V_{CE} = 300\text{ V}$, $T_A = 150\text{ °C}$, $R_{BE} = 2.7\text{ k}\Omega$	I_{CER}	– –	– –	1 50	μA
Emitter-base cutoff current $V_{EB} = 5\text{ V}$	I_{EB0}	–	–	10	
DC current gain ¹⁾ $I_C = 25\text{ mA}$, $V_{CE} = 20\text{ V}$	h_{FE}	40	–	–	–
Collector-emitter saturation voltage ¹⁾ $I_C = 10\text{ mA}$, $I_B = 1\text{ mA}$	V_{CEsat}	–	–	0.5	V
Base-emitter saturation voltage ¹⁾ $I_C = 10\text{ mA}$, $I_B = 1\text{ mA}$	V_{BEsat}	–	–	1	

AC characteristics

Transition frequency $I_C = 10\text{ mA}$, $V_{CE} = 10\text{ V}$, $f = 20\text{ MHz}$	f_t	–	100	–	MHz
Output capacitance $V_{CB} = 30\text{ V}$, $f = 1\text{ MHz}$	C_{obo}	–	0.8	–	pF

¹⁾ Pulse test conditions: $t \leq 300\text{ }\mu\text{s}$, $D = 2\text{ %}$.

Total power dissipation $P_{tot} = f(T_A^*; T_S)$

* Package mounted on epoxy

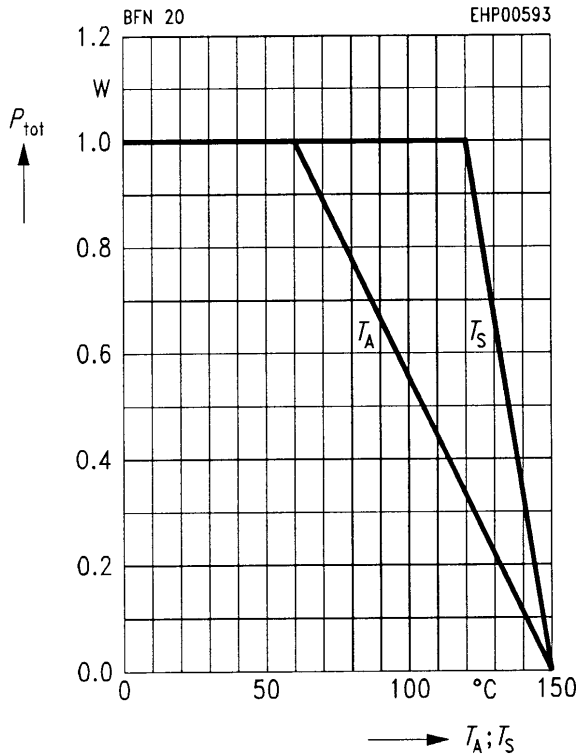

Output capacitance $C_{obo} = f(V_{CE})$

$f = 1$ MHz

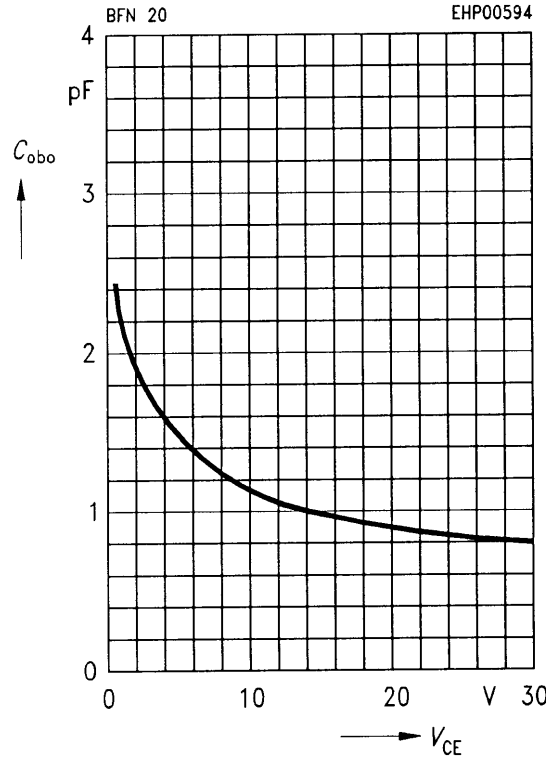

Permissible pulse load $P_{tot max} / P_{tot DC} = f(t_p)$

Transition frequency $f_T = f(I_C)$

$V_{CE} = 10$ V

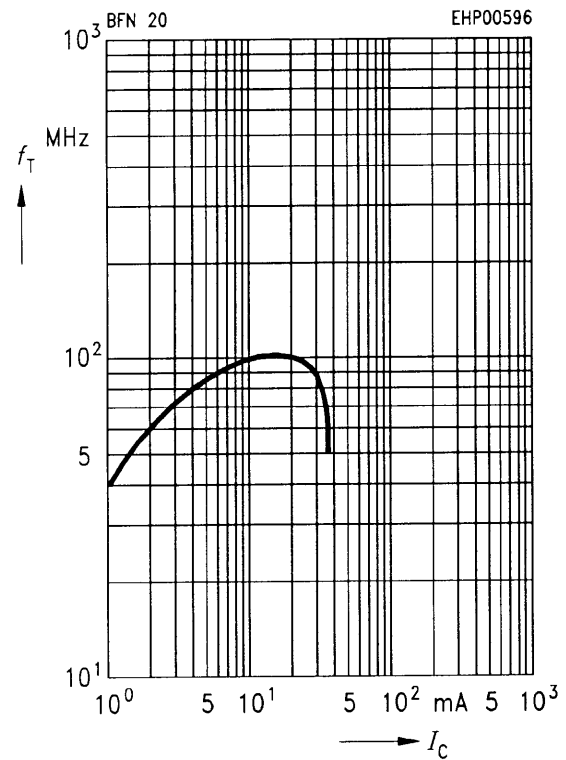
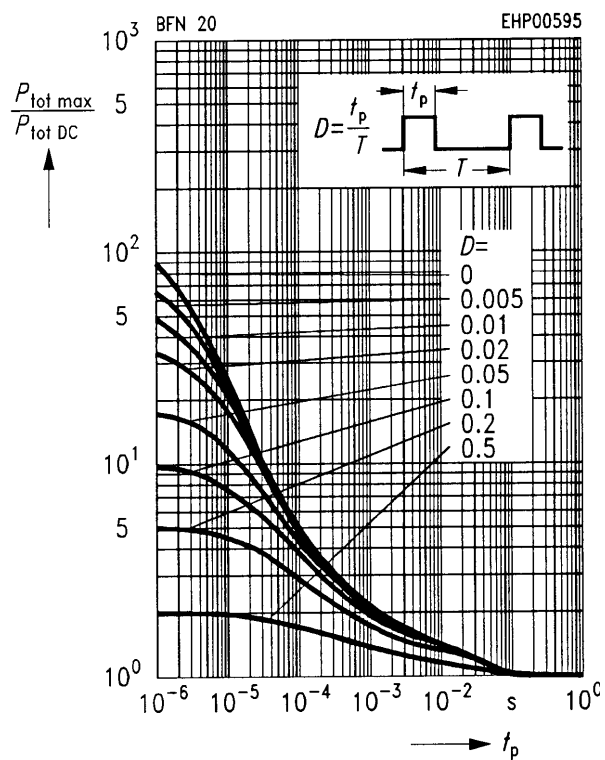

Collector current $I_C = f(V_{BE})$

$V_{CE} = 20\text{ V}$

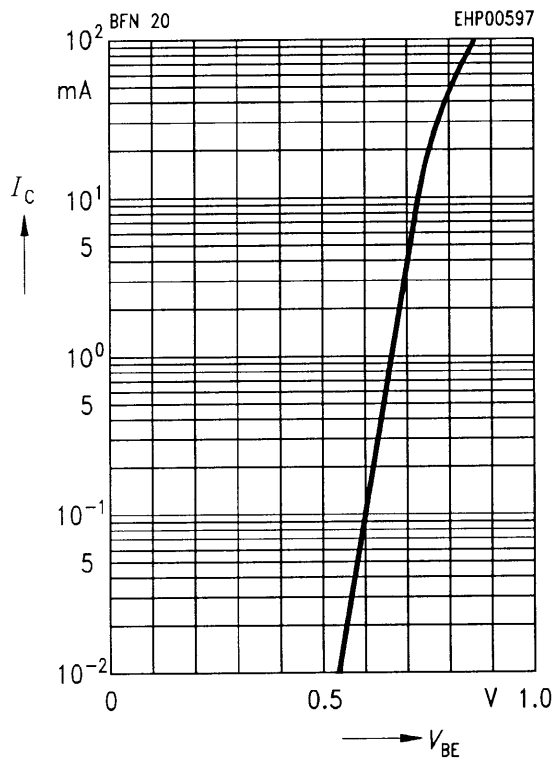

Collector cutoff current $I_{CB0} = f(T_A)$

$V_{CB} = 250\text{ V}$

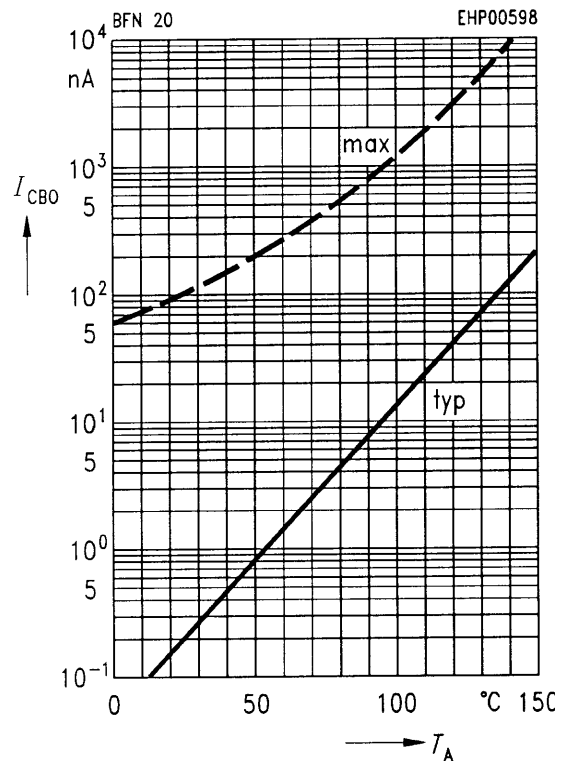

DC current gain $h_{FE} = f(I_C)$

$V_{CE} = 20\text{ V}$

