

## NPN Epitaxial Planar Transistor

# BTD2195M3

### Description

The BTD2195M3 is designed for use in general purpose amplifier and low speed switching application.

### Equivalent Circuit

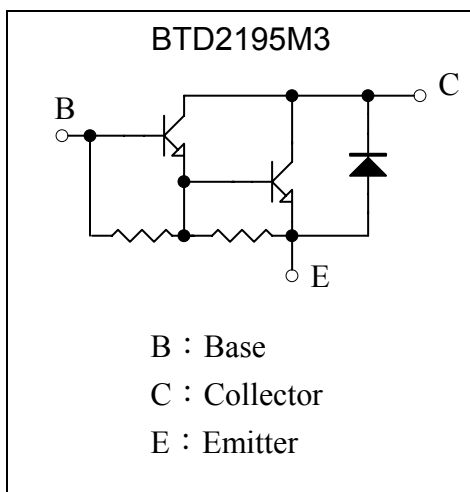

### Outline

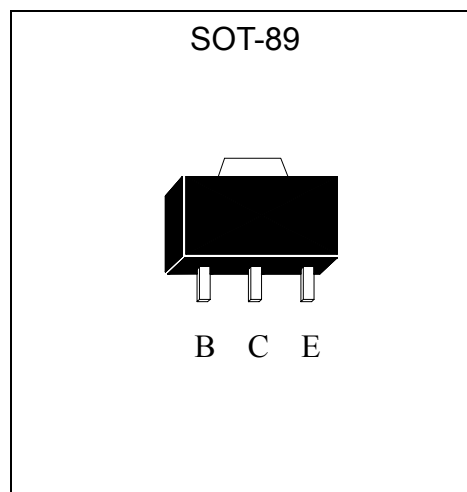

### Absolute Maximum Ratings (Ta=25°C)

Parameter	Symbol	Limits	Unit
Collector-Base Voltage	V <sub>CB0</sub>	130	V
Collector-Emitter Voltage	V <sub>CEO</sub>	120	V
Emitter-Base Voltage	V <sub>EB0</sub>	5	V
Collector Current (DC)	I <sub>C</sub>	4	A
Collector Current (Pulse)	I <sub>CP</sub>	6 (Note 1)	A
Power Dissipation	P <sub>d</sub>	0.6	W
		1 (Note 2)	W
		2 (Note 3)	W
Thermal Resistance, Junction to Ambient	R <sub>θJA</sub>	208	°C/W
		125 (Note 2)	°C/W
		62.5 (Note 3)	°C/W
Junction Temperature	T <sub>j</sub>	150	°C
Storage Temperature	T <sub>stg</sub>	-55~+150	°C

Note : 1. Single Pulse Pw ≤ 350μs, Duty ≤ 2%.

2. When mounted on a FR-4 PCB with area measuring 10×10×1 mm.

3. When mounted on a ceramic board with area measuring 40×40×1mm.



**Characteristics (Ta=25°C)**

Symbol	Min.	Typ.	Max.	Unit	Test Conditions
BV <sub>CEO</sub>	120	-	-	V	I <sub>C</sub> =1mA, I <sub>B</sub> =0
BV <sub>CBO</sub>	130	-	-	V	I <sub>C</sub> =100μA, I <sub>E</sub> =0
I <sub>CBO</sub>	-	-	1	mA	V <sub>CB</sub> =100V, I <sub>E</sub> =0
I <sub>CEO</sub>	-	-	2	mA	V <sub>CE</sub> =50V, I <sub>B</sub> =0
I <sub>EBO</sub>	-	-	2	mA	V <sub>EB</sub> =5V, I <sub>C</sub> =0
*V <sub>CE(sat)</sub>	-	-	1.2	V	I <sub>C</sub> =2A, I <sub>B</sub> =2mA
*V <sub>BE(on)</sub>			2.8	V	V <sub>CE</sub> =4V, I <sub>C</sub> =2A
*h <sub>FE1</sub>	1000	-	-	-	V <sub>CE</sub> =4V, I <sub>C</sub> =1A
*h <sub>FE2</sub>	500	-	-	-	V <sub>CE</sub> =4V, I <sub>C</sub> =2A
Cob	-		200	pF	V <sub>CB</sub> =10V, I <sub>E</sub> =0A, f=1MHz

\*Pulse Test : Pulse Width ≤380μs, Duty Cycle≤2%

## Characteristic Curves

Current Gain vs Collector Current

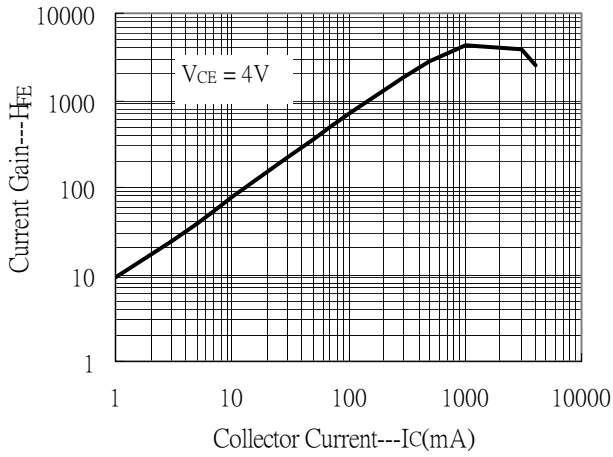

Saturation Voltage vs Collector Current

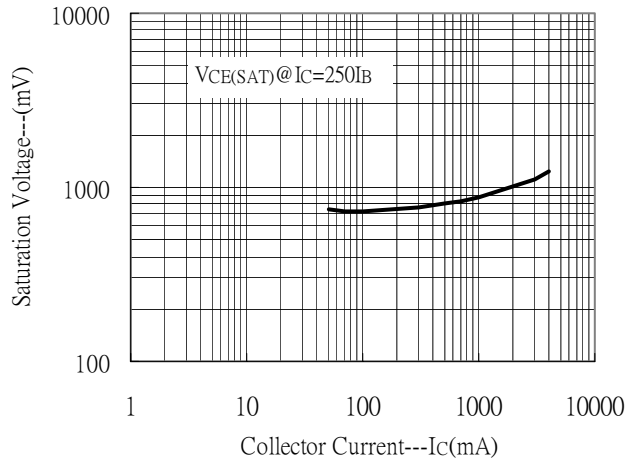

Saturation Voltage vs Collector Current

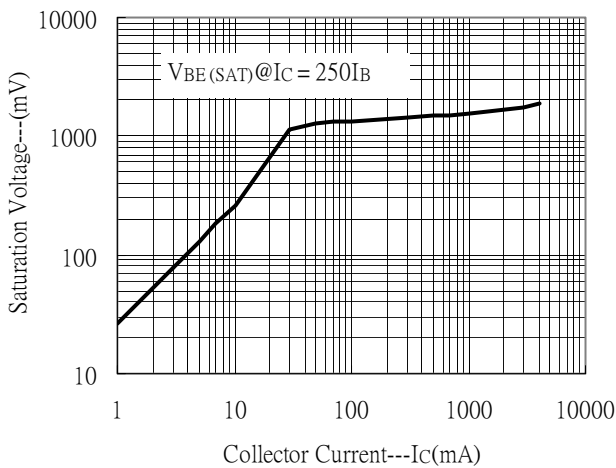

On voltage vs Collector Current

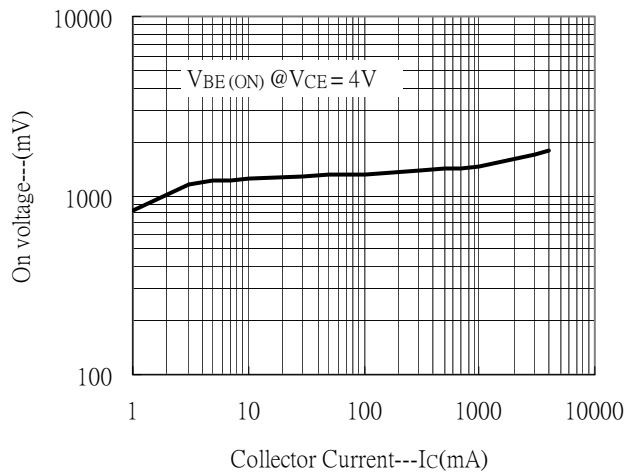

Power Derating Curves

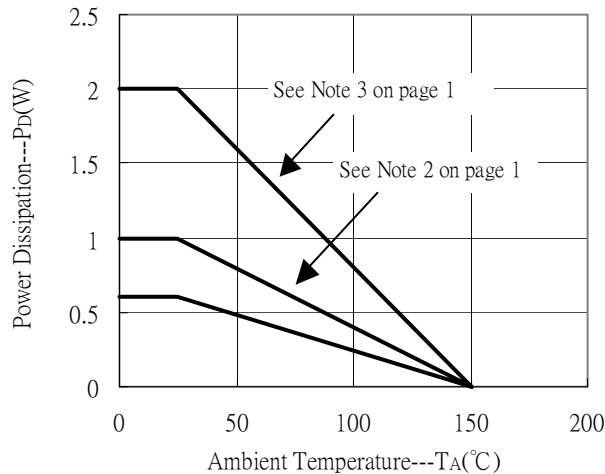

**SOT-89 Dimension**

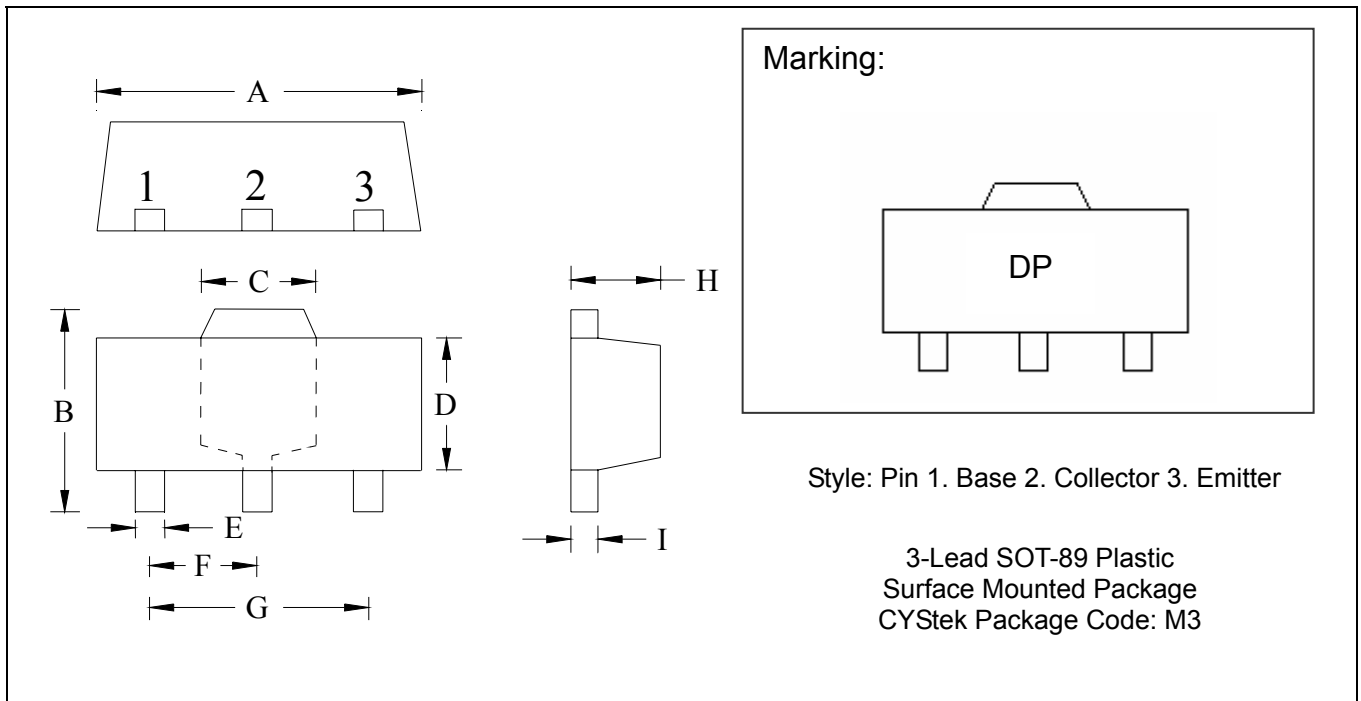

\*: Typical

DIM	Inches		Millimeters		DIM	Inches		Millimeters	
	Min.	Max.	Min.	Max.		Min.	Max.	Min.	Max.
A	0.1732	0.1811	4.40	4.60	F	0.0583	0.0598	1.48	1.527
B	0.1594	0.1673	4.05	4.25	G	0.1165	0.1197	2.96	3.04
C	0.0591	0.0663	1.50	1.70	H	0.0551	0.0630	1.40	1.60
D	0.0945	0.1024	2.40	2.60	I	0.0138	0.0161	0.35	0.41
E	0.01417	0.0201	0.36	0.51					

Notes: 1.Controlling dimension: millimeters.  
 2.Maximum lead thickness includes lead finish thickness, and minimum lead thickness is the minimum thickness of base material.  
 3.If there is any question with packing specification or packing method, please contact your local CYStek sales office.

**Material:**

- Lead: 42 Alloy ; solder plating
- Mold Compound: Epoxy resin family, flammability solid burning class: UL94V-0

**Important Notice:**

- All rights are reserved. Reproduction in whole or in part is prohibited without the prior written approval of CYStek.
- CYStek reserves the right to make changes to its products without notice.
- CYStek **semiconductor products are not warranted to be suitable for use in Life-Support Applications, or systems.**
- CYStek assumes no liability for any consequence of customer product design, infringement of patents, or application assistance.