

**TOPFET high side switch  
SMD version of BUK202-50Y**

**BUK206-50Y**

**DESCRIPTION**

Monolithic temperature and overload protected power switch based on MOSFET technology in a 5 pin plastic surface mount envelope, configured as a single high side switch.

**APPLICATIONS**

General controller for driving lamps, motors, solenoids, heaters.

**FEATURES**

- Vertical power DMOS switch
- Low on-state resistance
- 5 V logic compatible input
- Overtemperature protection - self resets with hysteresis
- Overload protection against short circuit load with output current limiting; latched - reset by input
- High supply voltage load protection
- Supply undervoltage lock out
- Status indication for overload protection activated
- Diagnostic status indication of open circuit load
- Very low quiescent current
- Voltage clamping for turn off of inductive loads
- ESD protection on all pins
- Reverse battery and overvoltage protection

**QUICK REFERENCE DATA**

SYMBOL	PARAMETER	MIN.	UNIT
$I_L$	Nominal load current (ISO)	9	A
SYMBOL	PARAMETER	MAX.	UNIT
$V_{BG}$	Continuous off-state supply voltage	50	V
$I_L$	Continuous load current	20	A
$T_j$	Continuous junction temperature	150	°C
$R_{ON}$	On-state resistance	38	mΩ

**FUNCTIONAL BLOCK DIAGRAM**

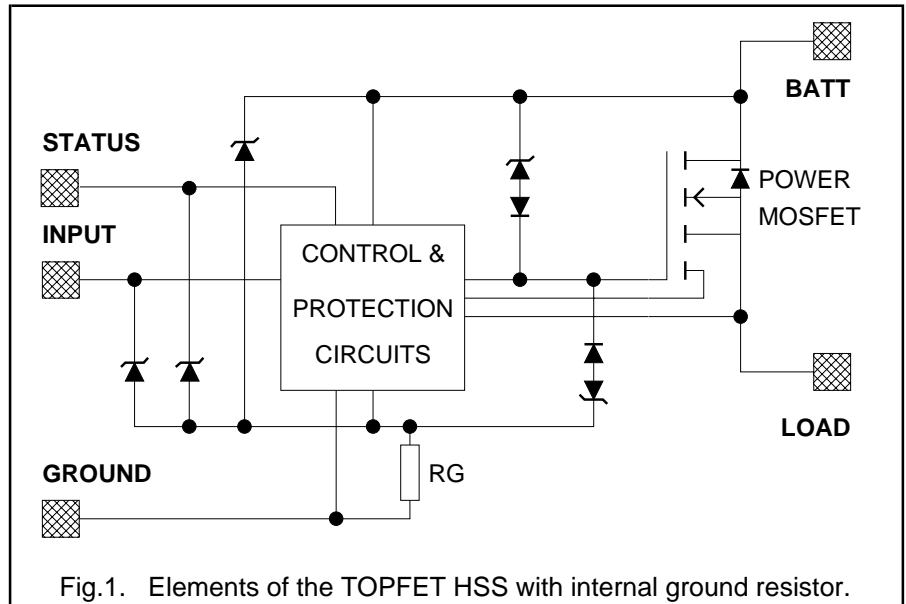

**PINNING - SOT426**

PIN	DESCRIPTION
1	Ground
2	Input
3	(connected to mb)
4	Status
5	Load
mb	Battery

**PIN CONFIGURATION**

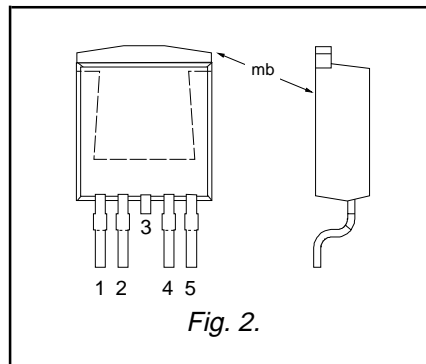

**SYMBOL**

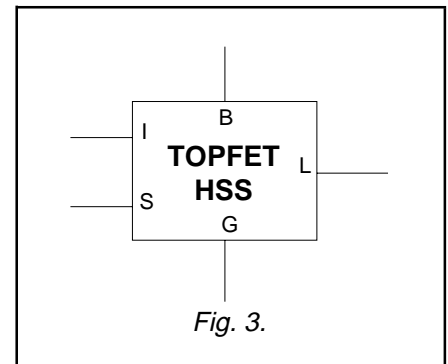

**TOPFET high side switch**  
**SMD version of BUK202-50Y**

BUK206-50Y

**LIMITING VALUES**

Limiting values in accordance with the Absolute Maximum System (IEC 134)

SYMBOL	PARAMETER	CONDITIONS	MIN.	MAX.	UNIT
$V_{BG}$	<b>Battery voltages</b> Continuous off-state supply voltage	-	0	50	V
$-V_{BG}$	<b>Reverse battery voltages<sup>1</sup></b> Repetitive peak supply voltage	External resistors: $R_I = R_S \geq 4.7 \text{ k}\Omega$ , $\delta \leq 0.1$	-	32	V
$-V_{BG}$	Continuous reverse supply voltage	$R_I = R_S \geq 4.7 \text{ k}\Omega$	-	16	V
$I_L$	Continuous load current	$T_{mb} \leq 110 \text{ }^\circ\text{C}$	-	20	A
$P_D$	Total power dissipation	$T_{mb} \leq 25 \text{ }^\circ\text{C}$	-	125	W
$T_{stg}$	Storage temperature	-	-55	175	$^\circ\text{C}$
$T_j$	Continuous junction temperature <sup>2</sup>	-	-	150	$^\circ\text{C}$
$T_{sold}$	Lead temperature	during soldering	-	250	$^\circ\text{C}$
	<b>Input and status</b>				
$I_I$	Continuous input current	-	-5	5	mA
$I_S$	Continuous status current	-	-5	5	mA
$I_I$	Repetitive peak input current	$\delta \leq 0.1$	-20	20	mA
$I_S$	Repetitive peak status current	$\delta \leq 0.1$	-20	20	mA
	<b>Inductive load clamping</b>				
$E_{BL}$	Non-repetitive clamping energy	$T_{mb} = 150 \text{ }^\circ\text{C}$ prior to turn-off	-	1.7	J

**ESD LIMITING VALUE**

SYMBOL	PARAMETER	CONDITIONS	MIN.	MAX.	UNIT
$V_C$	Electrostatic discharge capacitor voltage	Human body model; $C = 250 \text{ pF}$ ; $R = 1.5 \text{ k}\Omega$	-	2	kV

**THERMAL CHARACTERISTIC**

SYMBOL	PARAMETER	CONDITIONS	MIN.	TYP.	MAX.	UNIT
$R_{th \text{ j-mb}}$	<b>Thermal resistance<sup>3</sup></b> Junction to mounting base	-	-	0.8	1	K/W

<sup>1</sup> Reverse battery voltage is allowed only with external input and status resistors to limit the currents to a safe value.

<sup>2</sup> For normal continuous operation. A higher  $T_j$  is allowed as an overload condition but at the threshold  $T_{j(TO)}$  the over temperature trip operates to protect the switch.

<sup>3</sup> Of the output Power MOS transistor.

**TOPFET high side switch**  
**SMD version of BUK202-50Y**
**BUK206-50Y**
**STATIC CHARACTERISTICS**
 $T_{mb} = 25\text{ °C}$  unless otherwise stated

SYMBOL	PARAMETER	CONDITIONS	MIN.	TYP.	MAX.	UNIT
<b>Clamping voltages</b>						
$V_{BG}$	Battery to ground	$I_G = 1\text{ mA}$	50	55	65	V
$V_{BL}$	Battery to load	$I_L = I_G = 1\text{ mA}$	50	55	65	V
$-V_{LG}$	Negative load to ground	$I_L = 1\text{ mA}$	12	17	21	V
<b>Supply voltage</b>						
$V_{BG}$	Operating range <sup>1</sup>	battery to ground -	5	-	40	V
<b>Currents</b>						
$I_L$	Nominal load current <sup>2</sup>	$V_{BG} = 13\text{ V}$ $V_{BL} = 0.5\text{ V}$ ; $T_{mb} = 85\text{ °C}$	9	-	-	A
$I_B$	Quiescent current <sup>3</sup>	$V_{IG} = 0\text{ V}$ ; $V_{LG} = 0\text{ V}$	-	0.1	2	$\mu\text{A}$
$I_G$	Operating current <sup>4</sup>	$V_{IG} = 5\text{ V}$ ; $I_L = 0\text{ A}$	1.5	2.2	4	mA
$I_L$	Off-state load current <sup>5</sup>	$V_{BL} = 13\text{ V}$ ; $V_{IG} = 0\text{ V}$	-	0.1	1	$\mu\text{A}$
<b>Resistances</b>						
$R_{ON}$	On-state resistance <sup>6</sup>	$V_{BG} = 13\text{ V}$ ; $I_L = 10\text{ A}$ ; $t_p = 300\text{ }\mu\text{s}$	-	28	38	m $\Omega$
$R_{ON}$	On-state resistance	$V_{BG} = 5\text{ V}$ ; $I_L = 2\text{ A}$ ; $t_p = 300\text{ }\mu\text{s}$	-	36	48	m $\Omega$
$R_G$	Internal ground resistance	$I_G = 10\text{ mA}$	-	150	-	$\Omega$

**INPUT CHARACTERISTICS**
 $T_{mb} = 25\text{ °C}$ ;  $V_{BG} = 13\text{ V}$ 

SYMBOL	PARAMETER	CONDITIONS	MIN.	TYP.	MAX.	UNIT
$I_i$	Input current	$V_{IG} = 5\text{ V}$	35	60	100	$\mu\text{A}$
$V_{IG}$	Input clamping voltage	$I_i = 200\text{ }\mu\text{A}$	6	7.5	8.5	V
$V_{IG(ON)}$	Input turn-on threshold voltage		-	2.1	2.7	V
$V_{IG(OFF)}$	Input turn-off threshold voltage		1.5	2	-	V

<sup>1</sup> On-state resistance is increased if the supply voltage is less than 9 V. Refer to figure 8.

<sup>2</sup> Defined as in ISO 10483-1.

<sup>3</sup> This is the continuous current drawn from the supply when the input is low and includes leakage current to the load.

<sup>4</sup> This is the continuous current drawn from the supply with no load connected, but with the input high.

<sup>5</sup> The measured current is in the load pin only.

<sup>6</sup> The supply and input voltage for the  $R_{ON}$  tests are continuous. The specified pulse duration  $t_p$  refers only to the applied load current.

# TOPFET high side switch

## SMD version of BUK202-50Y

BUK206-50Y

### PROTECTION FUNCTIONS AND STATUS INDICATIONS

Truth table for normal, open-circuit load and overload conditions and abnormal supply voltages.

FUNCTIONS		TRUTH TABLE			THRESHOLD			
SYMBOL	CONDITION	INPUT	STATUS	OUTPUT	MIN.	TYP.	MAX.	UNIT
	Normal on-state	1	1	1				
	Normal off-state	0	1	0				
$I_{L(OC)}$	Open circuit load <sup>1</sup>	1	0	1	150	450	750	mA
	Open circuit load	0	1	0				
$T_{J(TO)}$	Over temperature <sup>2</sup>	1	0	0	150	175	-	°C
	Over temperature <sup>3</sup>	0	0	0				
$V_{BL(TO)}$	Short circuit load <sup>4</sup>	1	0	0	9	10.5	12	V
	Short circuit load	0	1	0				
$V_{BG(TO)}$	Low supply voltage <sup>5</sup>	X	1	0	3	4	5	V
$V_{BG(LP)}$	High supply voltage <sup>6</sup>	X	1	0	40	45	50	V

For input '0' equals low, '1' equals high, 'X' equals don't care.  
 For status '0' equals low, '1' equals open or high.  
 For output switch '0' equals off, '1' equals on.

### STATUS CHARACTERISTICS

$T_{mb} = 25\text{ °C}$ .

The status output is an open drain transistor, and requires an external pull-up circuit to indicate a logic high.

SYMBOL	PARAMETER	CONDITIONS	MIN.	TYP.	MAX.	UNIT
$V_{SG}$	Status clamping voltage	$I_S = 100\ \mu\text{A}$ ; $V_{IG} = 0\ \text{V}$	6	7	8	V
$V_{SG}$	Status low voltage	$I_S = 50\ \mu\text{A}$ ; $V_{BG} = 13\ \text{V}$ ; $V_{IG} = 5\ \text{V}$	-	0.7	0.8	V
$I_S$	Status leakage current	$V_{SG} = 5\ \text{V}$	-	0.1	1	$\mu\text{A}$
$I_S$	Status saturation current <sup>7</sup>	$V_{SS} = 5\ \text{V}$ ; $R_S = 0\ \Omega$ ; $V_{BG} = 13\ \text{V}$	-	5	-	mA
	<b>Application information</b>					
$R_S$	External pull-up resistor <sup>8</sup>	$V_{SS} = 5\ \text{V}$	-	100	-	k $\Omega$

1 In the on-state, the switch detects whether the load current is less than the quoted open load threshold current. This is for status indication only. Typical hysteresis equals 230 mA. The thresholds are specified for supply voltage within the normal working range.

2 After cooling below the reset temperature the switch will resume normal operation. The reset temperature is lower than the trip temperature by typically 10 °C.

3 If the overtemperature protection has operated, status remains low to indicate the overtemperature condition even if the input is taken low, providing the device has not cooled below the reset temperature.

4 After short circuit protection has operated, the input voltage must be toggled low for the switch to resume normal operation.

5 Undervoltage sensor causes the device to switch off. Typical hysteresis equals 0.5 V.

6 Overvoltage sensor causes the device to switch off. Typical hysteresis equals 1.3 V.

7 In a fault condition with the pull-up resistor short circuited while the status transistor is conducting.

8 The pull-up resistor also protects the status pin during reverse battery conditions.

# TOPFET high side switch

## SMD version of BUK202-50Y

BUK206-50Y

### DYNAMIC CHARACTERISTICS

 $T_{mb} = 25\text{ }^{\circ}\text{C}; V_{BG} = 13\text{ V}$ 

SYMBOL	PARAMETER	CONDITIONS	MIN.	TYP.	MAX.	UNIT
$-V_{LG}$	<b>Inductive load turn-off</b> Negative load voltage <sup>1</sup>	$V_{IG} = 0\text{ V}; I_L = 10\text{ A}; t_p = 300\text{ }\mu\text{s}$	15	20	25	V
$t_{d\text{ sc}}$	<b>Short circuit load protection<sup>2</sup></b> Response time	$V_{IG} = 5\text{ V}; R_L \leq 10\text{ m}\Omega$	-	75	-	$\mu\text{s}$
$I_L$	Load current prior to turn-off	$t < t_{d\text{ sc}}$	-	50	-	A
$I_{L(\text{lim})}$	<b>Overload protection<sup>3</sup></b> Load current limiting	$V_{BL} = 9\text{ V}; t_p = 300\text{ }\mu\text{s}$	34	45	64	A

### SWITCHING CHARACTERISTICS

 $T_{mb} = 25\text{ }^{\circ}\text{C}, V_{BG} = 13\text{ V}, \text{ for resistive load } R_L = 13\text{ }\Omega.$ 

SYMBOL	PARAMETER	CONDITIONS	MIN.	TYP.	MAX.	UNIT
$t_{d\text{ on}}$	<b>During turn-on</b> Delay time	to $V_{IG} = 5\text{ V}$ to 10% $V_L$	-	16	-	$\mu\text{s}$
$dV/dt_{\text{ on}}$	Rate of rise of load voltage		-	0.7	2	V/ $\mu\text{s}$
$t_{\text{ on}}$	Total switching time	to 90% $V_L$	-	140	-	$\mu\text{s}$
$t_{d\text{ off}}$	<b>During turn-off</b> Delay time	to $V_{IG} = 0\text{ V}$ to 90% $V_L$	-	40	-	$\mu\text{s}$
$dV/dt_{\text{ off}}$	Rate of fall of load voltage		-	0.7	2	V/ $\mu\text{s}$
$t_{\text{ off}}$	Total switching time	to 10% $V_L$	-	70	-	$\mu\text{s}$

### CAPACITANCES

 $T_{mb} = 25\text{ }^{\circ}\text{C}; f = 1\text{ MHz}; V_{IG} = 0\text{ V}$ 

SYMBOL	PARAMETER	CONDITIONS	MIN.	TYP.	MAX.	UNIT
$C_{ig}$	Input capacitance	$V_{BG} = 13\text{ V}$	-	15	20	pF
$C_{bl}$	Output capacitance	$V_{BL} = V_{BG} = 13\text{ V}$	-	500	700	pF
$C_{sg}$	Status capacitance	$V_{SG} = 5\text{ V}$	-	11	15	pF

1 For a high side switch, the load pin voltage goes negative with respect to ground during the turn-off of an inductive load. This negative voltage is clamped by the device.

2 The load current is self-limited during the response time for short circuit load protection. Response time is measured from when input goes high.

3 If the load resistance is low, but not a complete short circuit, such that the on-state voltage remains less than  $V_{BL(TO)}$ , the device remains in current limiting until the overtemperature protection operates.

TOPFET high side switch  
SMD version of BUK202-50Y

BUK206-50Y

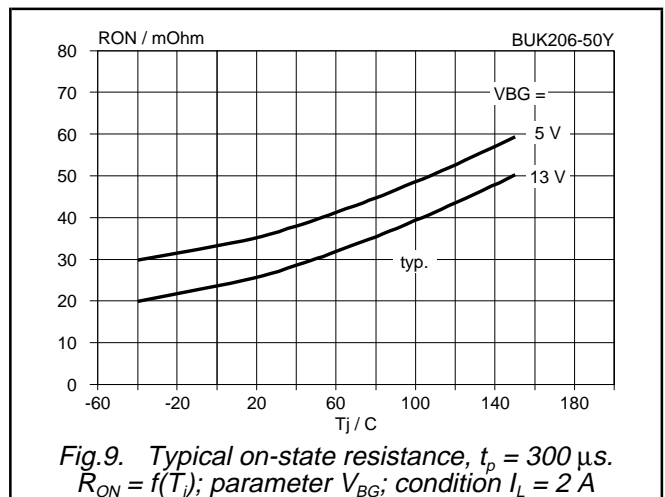
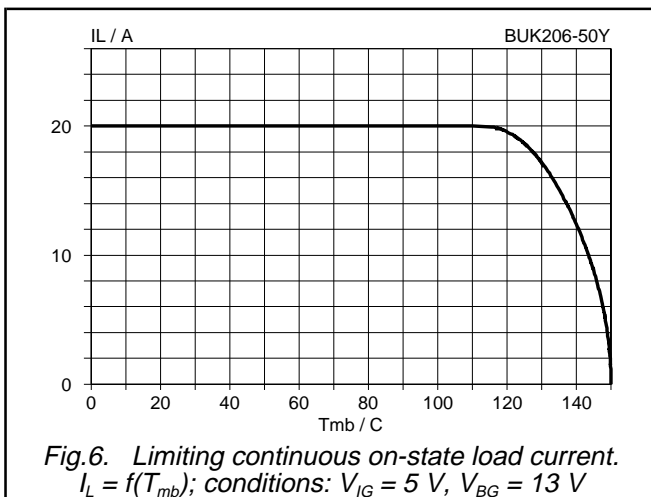
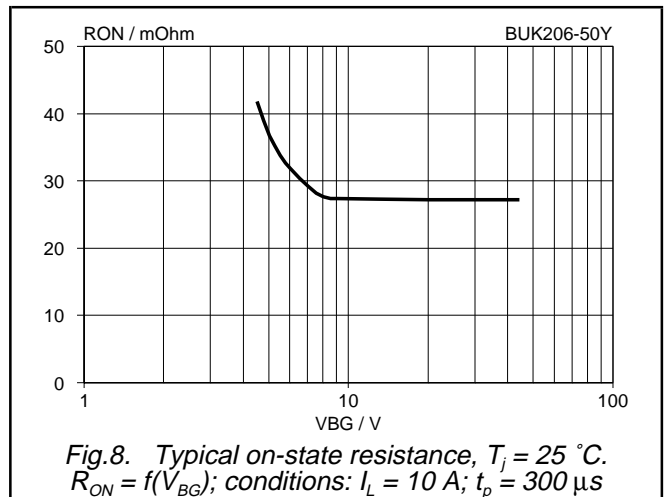
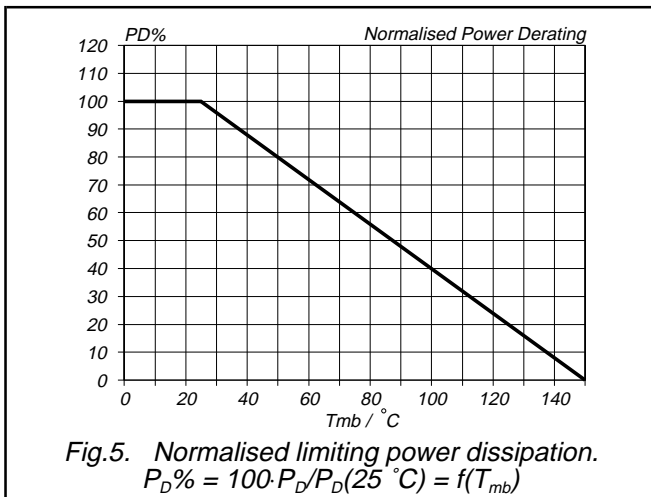
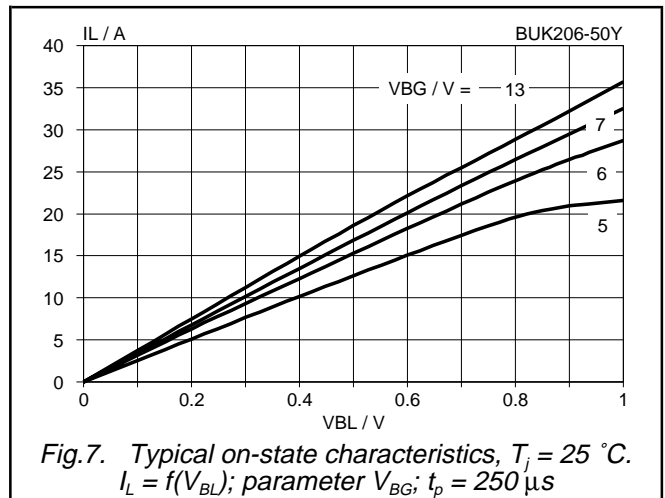

TOPFET high side switch  
SMD version of BUK202-50Y

BUK206-50Y

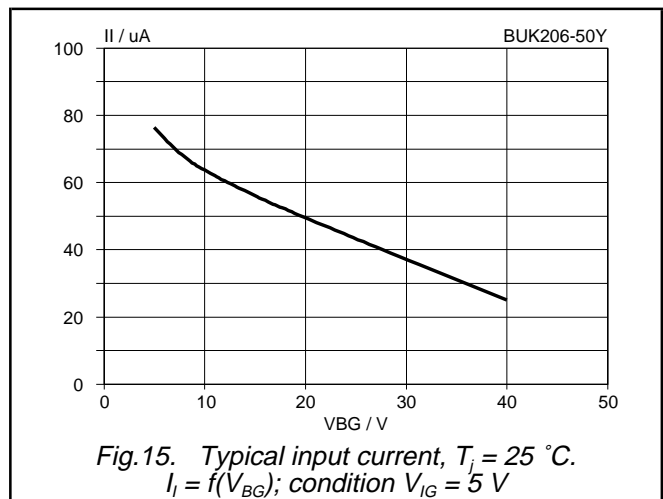
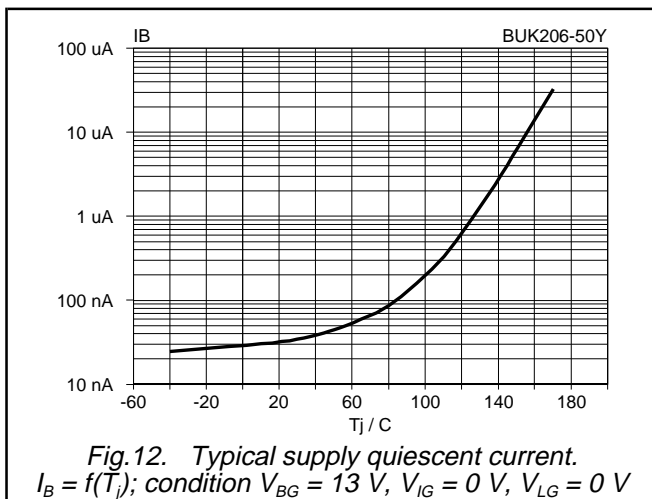
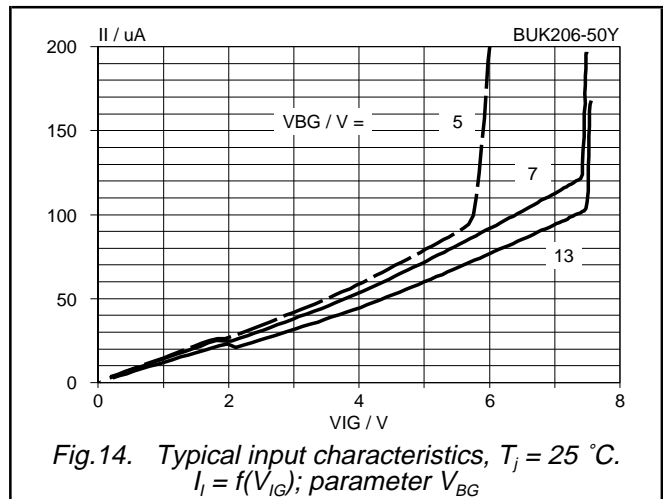
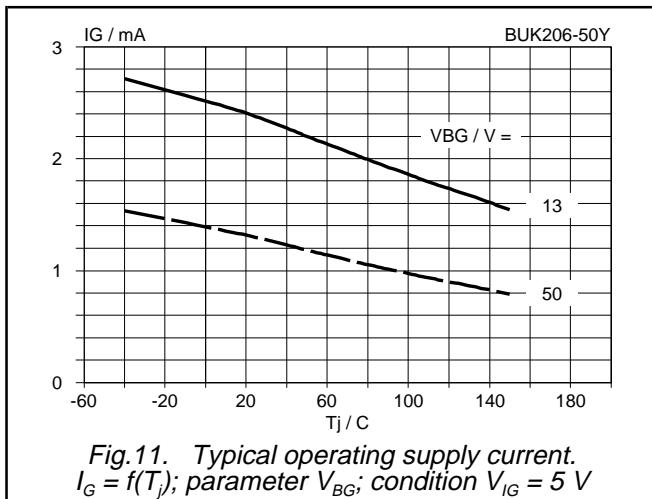
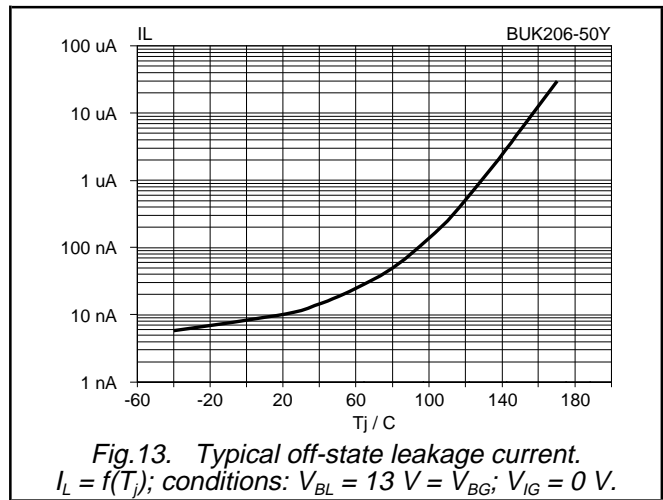
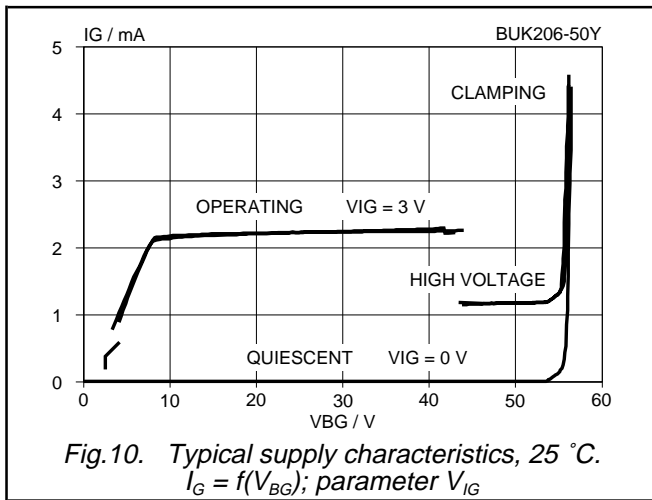

TOPFET high side switch  
SMD version of BUK202-50Y

BUK206-50Y

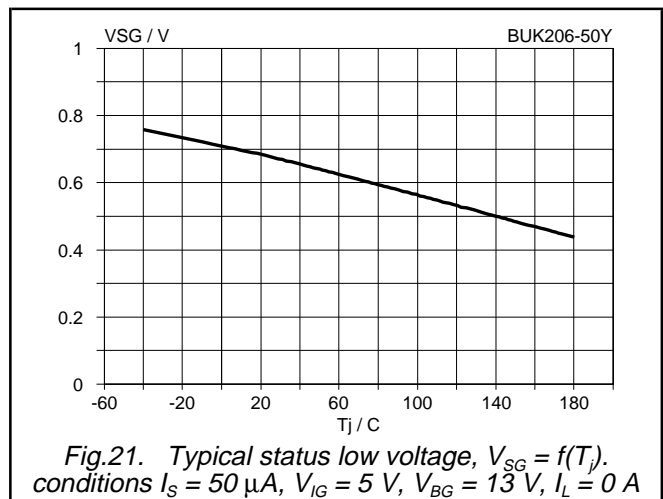
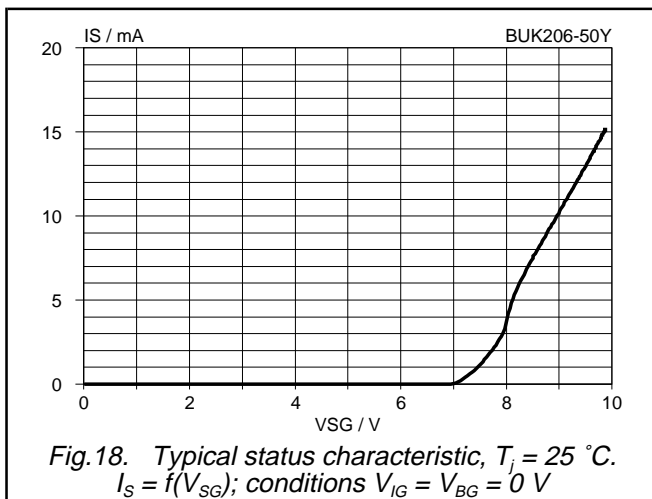
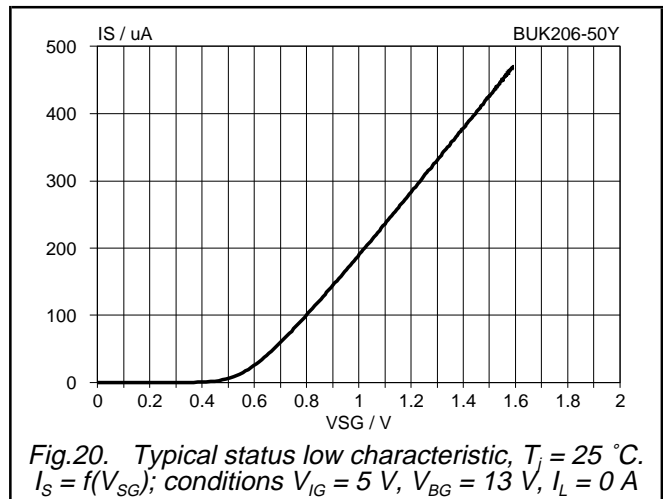
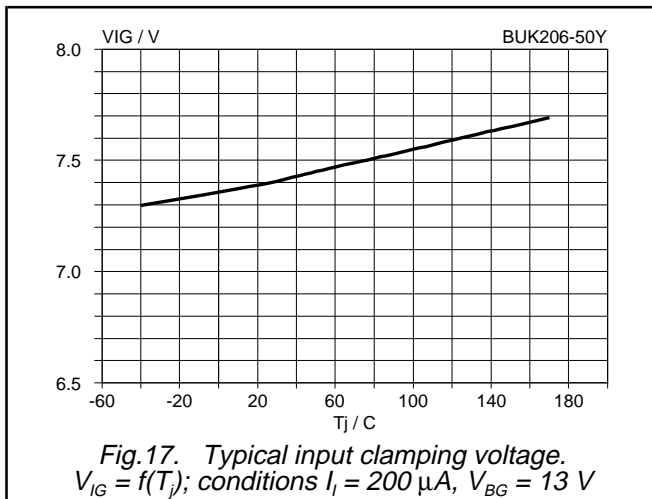
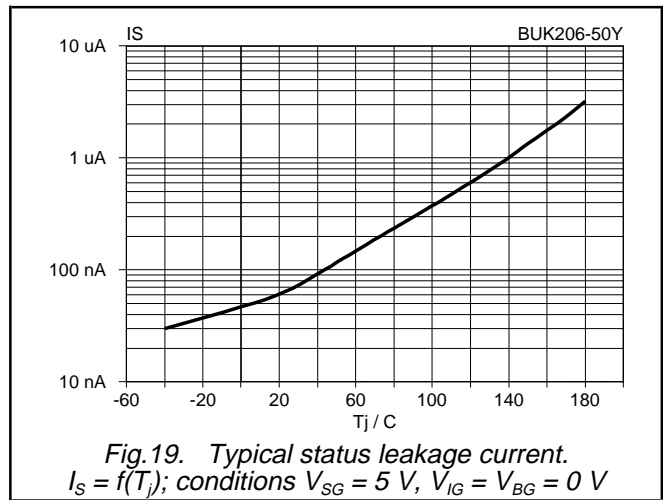
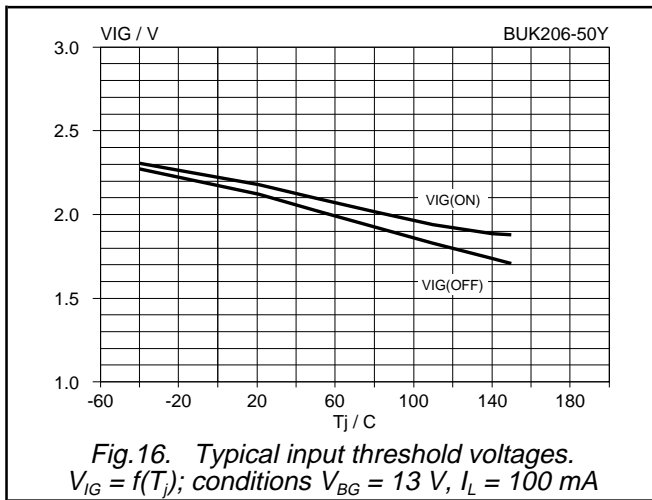



TOPFET high side switch  
SMD version of BUK202-50Y

BUK206-50Y

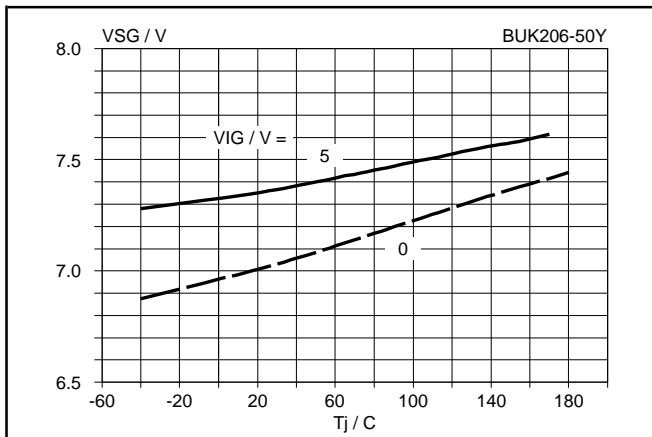

Fig.22. Typical status clamping voltage,  $V_{SG} = f(T_j)$ . parameter  $V_{IG}$ ; conditions  $I_S = 100 \mu A$ ,  $V_{BG} = 13 V$

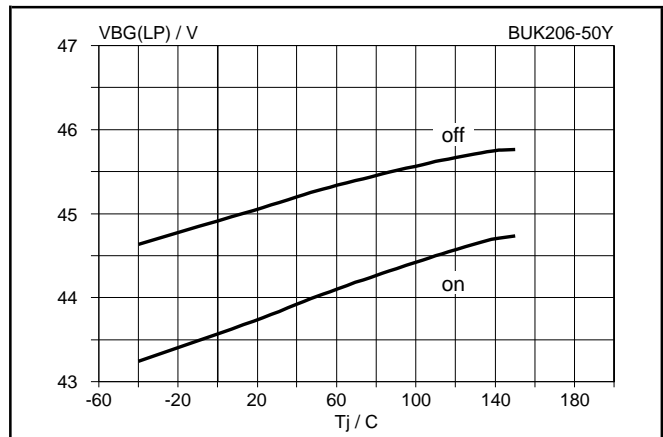

Fig.25. Supply typical overvoltage thresholds.  $V_{BG(LP)} = f(T_j)$ ; conditions  $V_{IG} = 5 V$ ;  $I_L = 100 mA$

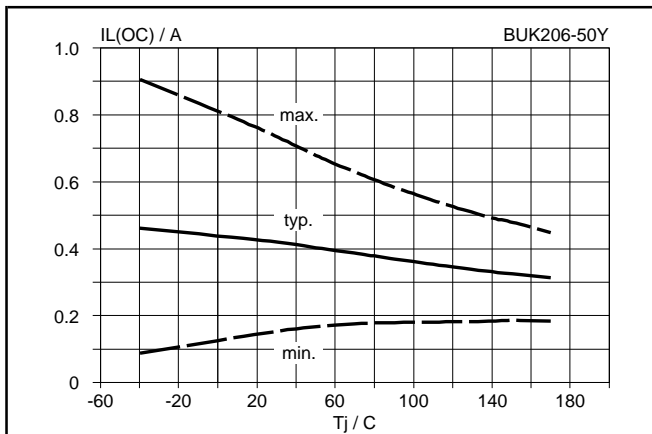

Fig.23. Low load current detection threshold.  $I_{L(OC)} = f(T_j)$ ; conditions  $V_{IG} = 5 V$ ;  $V_{BG} = 13 V$

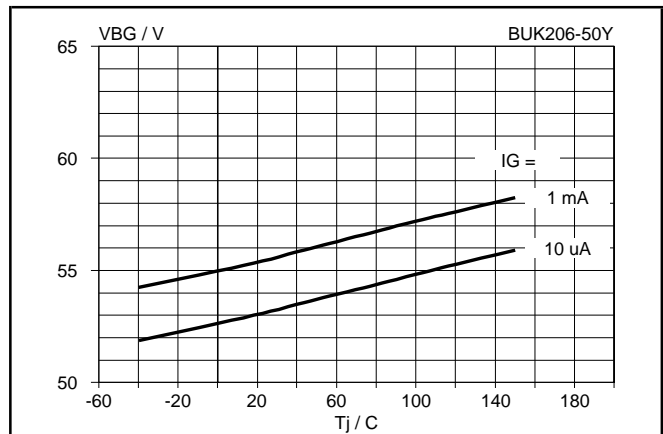

Fig.26. Typical battery to ground clamping voltage.  $V_{BG} = f(T_j)$ ; parameter  $I_G$

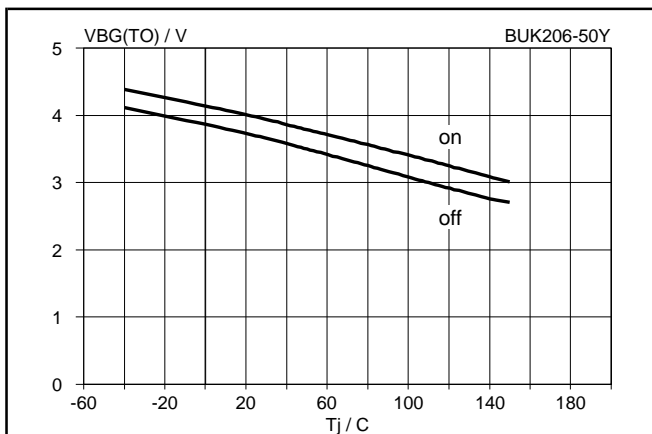

Fig.24. Supply typical undervoltage thresholds.  $V_{BG(TO)} = f(T_j)$ ; conditions  $V_{IG} = 3 V$ ;  $I_L = 100 mA$

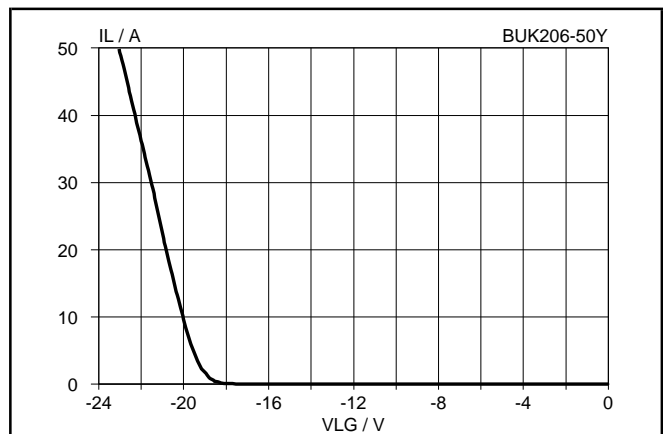
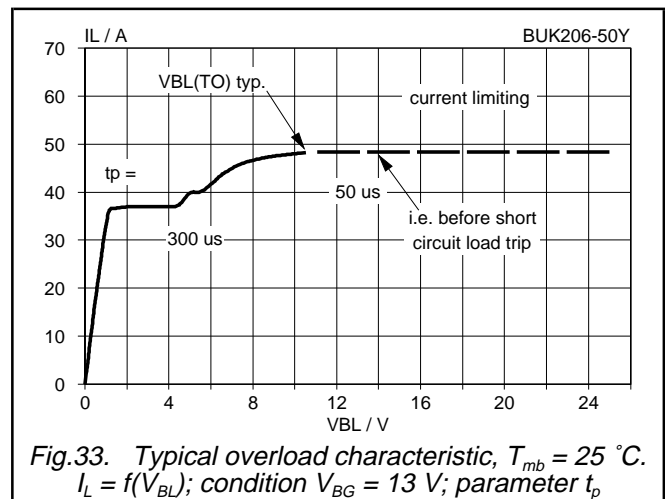
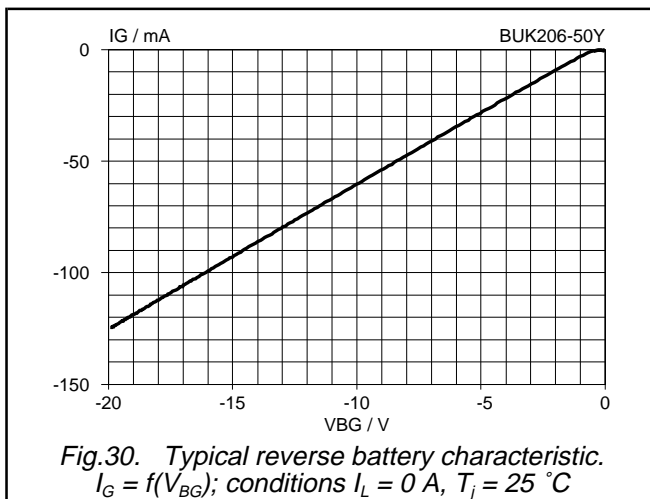
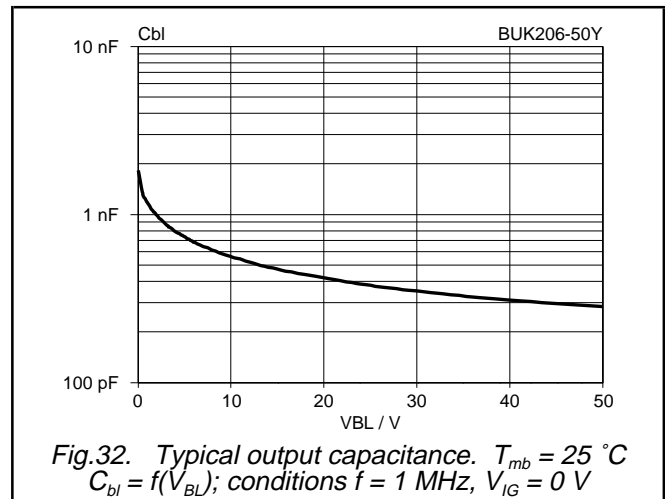
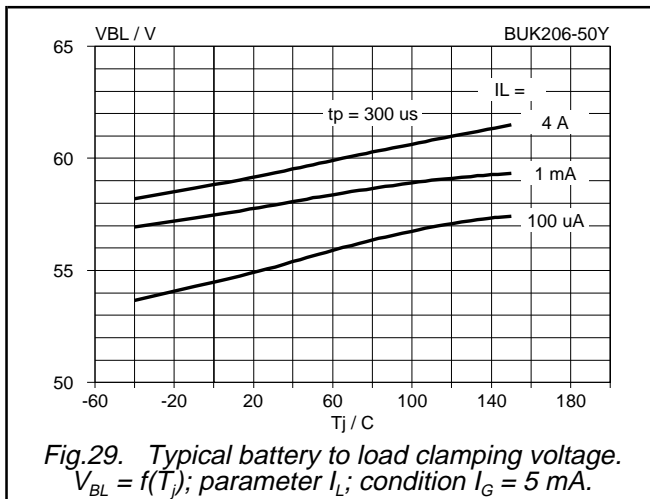
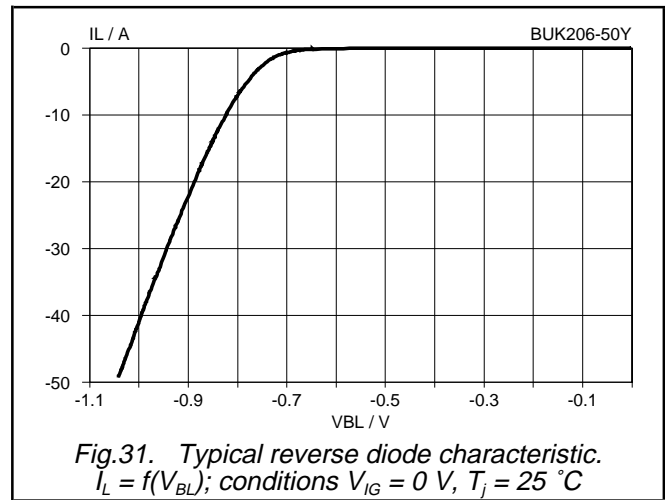
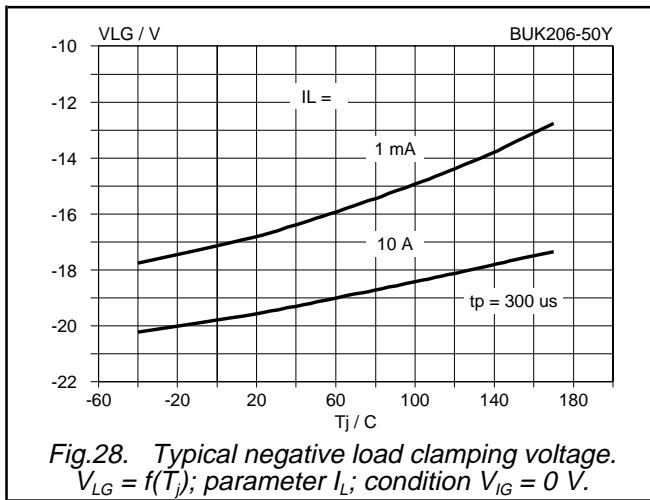

Fig.27. Typical negative load clamping characteristic.  $I_L = f(V_{LG})$ ; conditions  $V_{IG} = 0 V$ ,  $t_p = 300 \mu s$ ,  $25^\circ C$

TOPFET high side switch  
SMD version of BUK202-50Y

BUK206-50Y



TOPFET high side switch  
SMD version of BUK202-50Y

BUK206-50Y

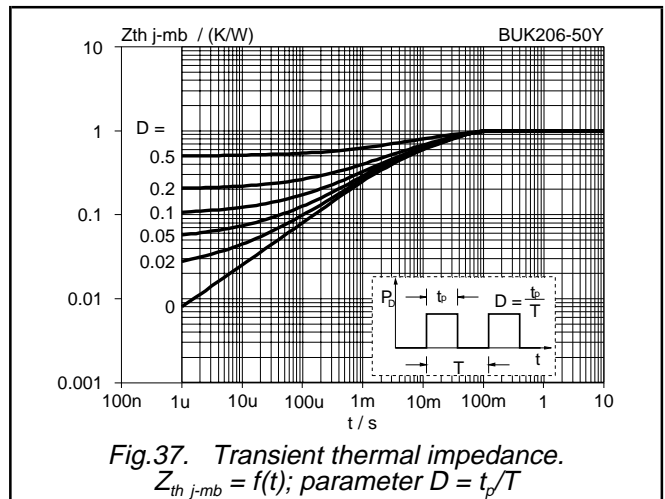
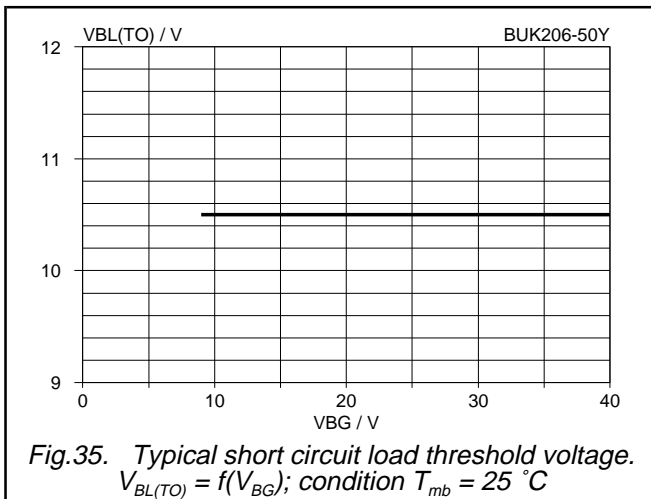
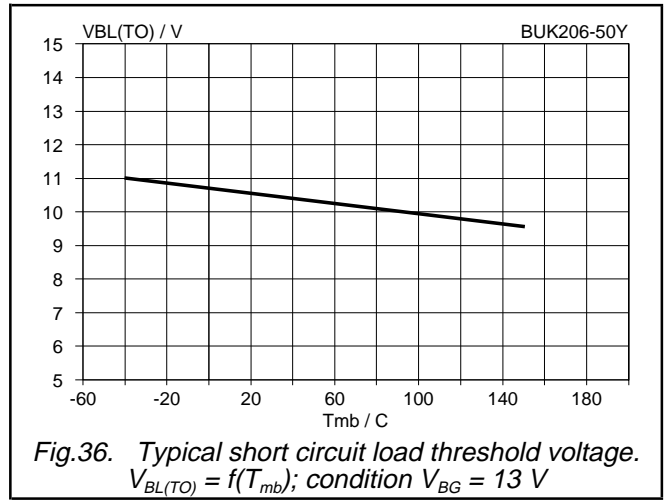
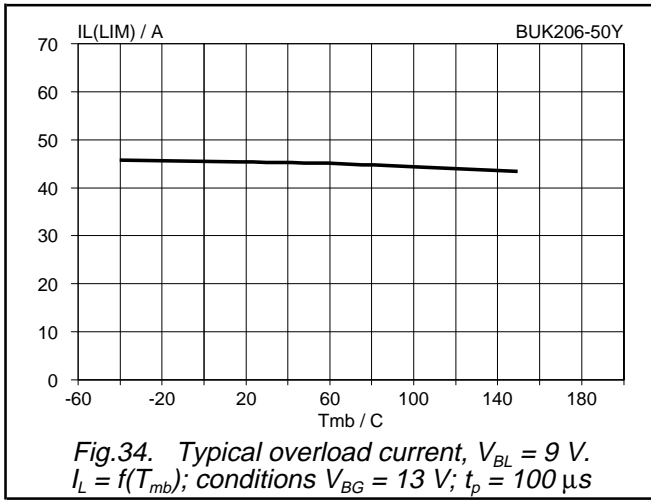

TOPFET high side switch  
SMD version of BUK202-50Y

BUK206-50Y

**MECHANICAL DATA**



**MOUNTING INSTRUCTIONS**



TOPFET high side switch  
SMD version of BUK202-50Y

BUK206-50Y

**DEFINITIONS**

<b>Data sheet status</b>	
Objective specification	This data sheet contains target or goal specifications for product development.
Preliminary specification	This data sheet contains preliminary data; supplementary data may be published later.
Product specification	This data sheet contains final product specifications.
<b>Limiting values</b>	
Limiting values are given in accordance with the Absolute Maximum Rating System (IEC 134). Stress above one or more of the limiting values may cause permanent damage to the device. These are stress ratings only and operation of the device at these or at any other conditions above those given in the Characteristics sections of this specification is not implied. Exposure to limiting values for extended periods may affect device reliability.	
<b>Application information</b>	
Where application information is given, it is advisory and does not form part of the specification.	
© Philips Electronics N.V. 1996	
All rights are reserved. Reproduction in whole or in part is prohibited without the prior written consent of the copyright owner.	
The information presented in this document does not form part of any quotation or contract, it is believed to be accurate and reliable and may be changed without notice. No liability will be accepted by the publisher for any consequence of its use. Publication thereof does not convey nor imply any license under patent or other industrial or intellectual property rights.	

**LIFE SUPPORT APPLICATIONS**

These products are not designed for use in life support appliances, devices or systems where malfunction of these products can be reasonably expected to result in personal injury. Philips customers using or selling these products for use in such applications do so at their own risk and agree to fully indemnify Philips for any damages resulting from such improper use or sale.