

T-79-05-10



**CA741C, CA741, CA1458,  
CA1558, LM741\*, LM741C\*,  
LM1458\*, LM1558\***

**High-Gain Single and Dual Operational Amplifiers  
for Military, Industrial and Commercial Applications**

August 1991

**3**  
OPERATIONAL  
AMPLIFIERS

**Features:**

- Input Bias Current (All Types) ..... 500nA (Max.)
- Input Offset Current (All Types) ..... 200nA (Max.)

**Applications**

- Comparator
- DC Amplifier
- Integrator or Differentiator
- Multivibrator
- Narrow-Band or Band-Pass Filter
- Summing Amplifier

**Description**

The CA1458, CA1558 (dual types); CA741C, CA741 (single-types); high-gain operational amplifiers for use in military, industrial, and commercial applications.

These monolithic silicon integrated-circuit devices provide output short-circuit protection and latch-free operation. These types also feature wide common-mode and differential-mode signal ranges and have low-offset voltage nulling capability when used with an appropriately valued potentiometer. A 10-kohm potentiometer is used for offset nulling types CA741C, CA741 (See Fig. 9); and types CA1458, CA1558, have no specific terminals for offset nulling. Each type consists of a differential-input amplifier that effectively drives a gain and level-shifting stage having a complementary emitter-follower output.

The manufacturing process make it possible to produce IC operational amplifiers with low-burst ("popcorn") noise characteristics. The CA741 gives limit specifications for burst noise in the data bulletin, File No. 530. Contact your Sales Representative for information pertinent to other operational amplifier types that meet low-burst noise specifications.

This operational amplifier line also offers the circuit designer the option of operation with internal or external phase compensation.

Unity gain with external phase compensation can be obtained with a single 30-pF capacitor. All the other types are internally phase-compensated.

TYPE NO.	NO. OF AMPL.	PHASE COMP.	OFFSET VOLTAGE NULL	MINIMUM AOL	MAXIMUM VIO (mV)	OPERATING TEMPERATURE RANGE (°C)
CA1458	Dual	Int.	No	20k	6	0 to 70 <sup>▲</sup>
CA1558	Dual	Int.	No	50k	6	-55 to 125
CA741C	Single	Int.	Yes	20k	6	0 to 70 <sup>▲</sup>
CA741	Single	Int.	Yes	50k	6	-55 to +125

<sup>▲</sup> All types in any package style can be operated over the temperature range of -55 to +125°C, although the published limits for certain electrical specifications apply only over the temperature range of 0 to +70°C.

\* Technical Data on LM Branded types is identical to the corresponding CA Branded types.  
CAUTION: These devices are sensitive to electrostatic discharge. Proper I.C. handling procedures should be followed.  
Copyright © Harris Corporation 1991

File Number **531.1**

**CA741C, CA741, CA1458, CA1558, LM741, LM741C, LM1458, LM1558**

**Ordering Information**

**T-79-05-10**

When ordering any of these types, it is important that the appropriate suffix letter for the package required be affixed to the type number. For example: If a CA1458 in a straight-lead TO-5 style package is desired, order CA1458T.

TYPE NO.	PACKAGE TYPE AND SUFFIX LETTER							FIG. NO
	TO-5 STYLE			PLASTIC		CHIP	BEAM LEAD	
	8L	10L	DIL-CAN	8L	14L			
CA1458	T	-	S	E	-	H	-	1b, 1d
CA1558	T	-	S	E	-	-	-	1b, 1d
CA741C	T	-	S	E	-	H	-	1a, 1c
CA741	T	-	S	E	-	-	L	1a, 1c

**Absolute Maximum Ratings**  $T_A = +25^\circ\text{C}$

DC Supply Voltage (Between V+ and V- Terminals):

CA741C, CA1458 (Note 2) ..... 36V  
 CA741, CA1558 (Note 2) ..... 44V

Differential Input Voltage .....  $\pm 30\text{V}$

DC Input Voltage (Note 1) .....  $\pm 15\text{V}$

Output Short-Circuit Duration ..... Indefinite

Device Dissipation:

Up to  $+70^\circ\text{C}$  (CA741C) ..... 500mW

Up to  $+75^\circ\text{C}$  (CA741) ..... 500mW

Up to  $+30^\circ\text{C}$  (CA1558) ..... 680mW

Up to  $+25^\circ\text{C}$  (CA1458) ..... 680mW

For Temperatures Exceeding Those Indicated Above ..... Derate Linearly  $8.67\text{mW}/^\circ\text{C}$

Voltage Between Offset Null and V- (CA741C, CA741) .....  $\pm 0.5\text{V}$

Ambient Operating Temperature Range:

CA741, CA1558 .....  $-55$  to  $+125^\circ\text{C}$

CA741C, CA1458 .....  $0$  to  $+70^\circ\text{C}$  (Note 3)

Ambient Storage Temperature Range .....  $-65$  to  $+150^\circ\text{C}$

Lead Temperature (During Soldering):

At Distance  $1/16 \pm 1/32$  Inch ( $1.59 \pm 0.79\text{mm}$ ) from Case for 10 Seconds Max .....  $+265^\circ\text{C}$

NOTES: 1. If Supply Voltage is Less than  $\pm 15$  Volts, the Absolute Maximum Input Voltage is Equal to the Supply Voltage.

2. Voltage Values Apply for Each of the Dual Operational Amplifiers.

3. All Types in any Package Style Can Be Operated Over the Temperature Range of  $-55$  to  $+125^\circ\text{C}$ , Although the Published Limits for Certain Electrical Specifications Apply Only Over the Temperature Range of  $0$  to  $+70^\circ\text{C}$

CA741C, CA741, CA1458, CA1558, LM741, LM741C, LM1458, LM1558

T-79-05-10

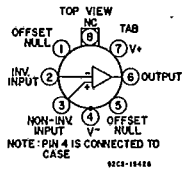

FIGURE 1a. CA741CS, CA741CT, CA741S, & CA741T WITH INTERNAL PHASE COMPENSATION.

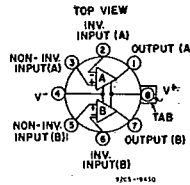

FIGURE 1b. CA1458S, CA1458T, CA1558S, & CA1558T AND INTERNAL PHASE COMPENSATION

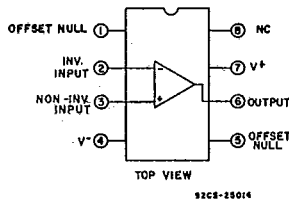

FIGURE 1c. CA741C AND CA741E WITH INTERNAL PHASE COMPENSATION

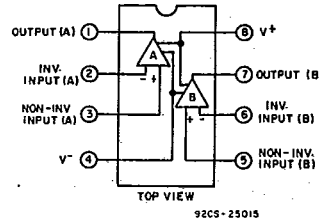

FIGURE 1d. CA1458E AND CA1558E WITH INTERNAL PHASE COMPENSATION

3  
OPERATIONAL AMPLIFIERS

FIGURE 1. FUNCTIONAL DIAGRAMS

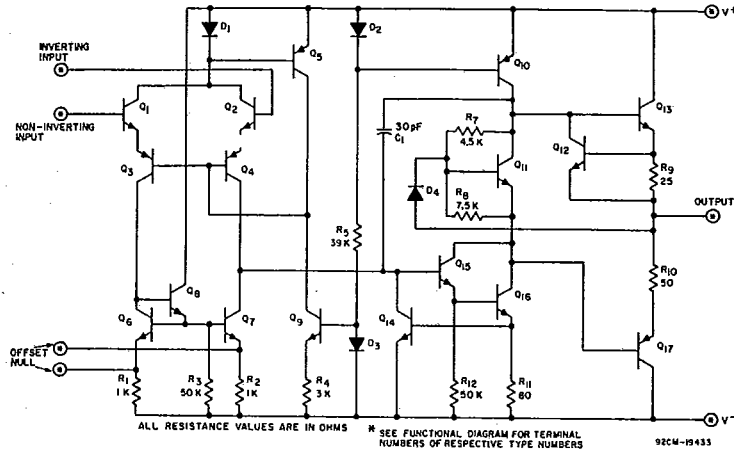

FIGURE 2. SCHEMATIC DIAGRAM OF OPERATIONAL AMPLIFIERS WITH INTERNAL PHASE COMPENSATION FOR CA741C, CA741, AND FOR EACH AMPLIFIER OF THE CA1458, AND CA1558

## CA741C, CA741, CA1458, CA1558, LM741, LM741C, LM1458, LM1558

ELECTRICAL CHARACTERISTICS  
Typical Values Intended Only for Design Guidance

T-79-05-10

CHARACTERISTIC	TEST CONDITIONS $V_{\pm} = \pm 15V$	TYPICAL VALUES ALL TYPES	UNITS
Input Capacitance, $C_I$		1.4	pF
Offset Voltage Adjustment Range		$\pm 15$	mV
Output Resistance, $R_O$		75	$\Omega$
Output Short-Circuit Current		25	mA
Transient Response:	Unity Gain $V_I = 20mV, R_L = 2k\Omega,$ $C_L \leq 100pF$		
Rise Time, $t_r$		0.3	$\mu s$
Overshoot		5	%
Slew Rate, $S_R$ :			
Closed Loop	$R_L \geq 2k\Omega$	0.5	V/ $\mu s$

ELECTRICAL CHARACTERISTICS  
For Equipment Design

CHARACTERISTIC	TEST CONDITIONS Supply Voltage, $V^+ = 15V,$ $V^- = -15V$	Ambient Temperature, $T_A$	LIMITS			UNITS
			CA741C CA1458*			
			Min.	Typ.	Max.	
Input Offset Voltage, $V_{IO}$	$R_S \leq 10k\Omega$	25 °C	—	2	6	mV
		0 to 70 °C	—	—	7.5	
Input Offset Current, $I_{IO}$		25 °C	—	20	200	nA
		0 to 70 °C	—	—	300	
Input Bias Current, $I_{IB}$		25 °C	—	80	500	nA
		0 to 70 °C	—	—	800	
Input Resistance, $R_I$			0.3	2	—	M $\Omega$
Open-Loop Differential Voltage Gain, $A_{OL}$	$R_L \geq 2k\Omega$ $V_O = \pm 10V$	25 °C	20,000	200,000	—	
		0 to 70 °C	15,000	—	—	
Common-Mode Input Voltage Range, $V_{ICR}$		25 °C	$\pm 12$	$\pm 13$	—	V
Common-Mode Rejection Ratio, CMRR	$R_S \leq 10k\Omega$	25 °C	70	90	—	dB
Supply-Voltage Rejection Ratio, PSRR	$R_S \leq 10k\Omega$	25 °C	—	30	150	$\mu V/V$
Output Voltage Swing, $V_{OPP}$	$R_L \geq 10k\Omega$	25 °C	$\pm 12$	$\pm 14$	—	V
		25 °C	$\pm 10$	$\pm 13$	—	
	0 to 70 °C	$\pm 10$	$\pm 13$	—		
Supply Current, $I^{\pm}$		25 °C	—	1.7	2.8	mA
Device Dissipation, $P_D$		25 °C	—	50	85	mW

\* Values apply for each section of the dual amplifiers.

CA741C, CA741, CA1458, CA1558, LM741, LM741C, LM1458, LM1558

ELECTRICAL CHARACTERISTICS  
For Equipment Design

T-79-05-10

CHARACTERISTIC	TEST CONDITIONS Supply Voltage, V <sup>+</sup> = 15 V, V <sup>-</sup> = -15 V	LIMITS	UNITS			
			Ambient Temperature, T <sub>A</sub>	CA741 CA1558*		
				Min.	Typ.	Max.
Input Offset Voltage, V <sub>IO</sub>	R <sub>S</sub> ≤ 10 kΩ	25 °C	-	1	5	mV
		-55 to +125 °C	-	1	6	
Input Offset Current, I <sub>IO</sub>		25 °C	-	20	200	nA
		-55 °C	-	85	500	
		+125 °C	-	7	200	
Input Bias Current, I <sub>IB</sub>		25 °C	-	80	500	nA
		-55 °C	-	300	1500	
		+125 °C	-	30	500	
Input Resistance, R <sub>I</sub>			0.3	2	-	MΩ
Open-Loop Differential Voltage Gain, A <sub>OL</sub>	R <sub>L</sub> ≥ 2 kΩ V <sub>O</sub> = ±10 V	25 °C	50,000	200,000	-	
		-55 to +125 °C	25,000	-	-	
Common-Mode Input Voltage Range, V <sub>ICR</sub>		-55 to +125 °C	±12	±13	-	V
Common-Mode Rejection Ratio, CMRR	R <sub>S</sub> ≤ 10 kΩ	-55 to +125 °C	70	90	-	dB
Supply Voltage Rejection Ratio, PSRR	R <sub>S</sub> ≤ 10 kΩ	-55 to +125 °C	-	30	150	μV/V
Output Voltage Swing, V <sub>OPP</sub>	R <sub>L</sub> ≥ 10 kΩ	-55 to +125 °C	±12	±14	-	V
	R <sub>L</sub> ≥ 2 kΩ	-55 to +125 °C	±10	±13	-	
Supply Current, I <sup>±</sup>		25 °C	-	1.7	2.8	mA
		-55 °C	-	2	3.3	
		+125 °C	-	1.5	2.5	
Device Dissipation, P <sub>D</sub>		25 °C	-	50	85	mW
		-55 °C	-	60	100	
		+125 °C	-	45	75	

\* Values apply for each section of the dual amplifiers.

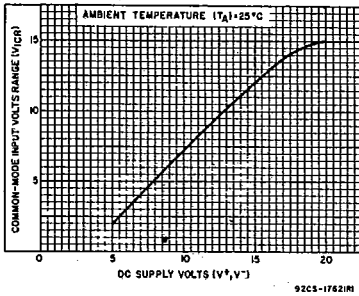

FIGURE 3. COMMON-MODE INPUT VOLTAGE RANGE vs. SUPPLY VOLTAGE FOR ALL TYPES.

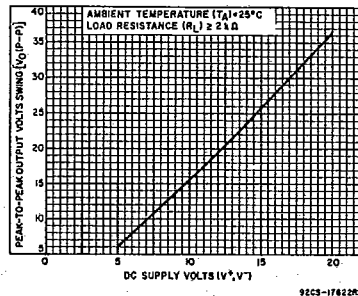

FIGURE 4. PEAK-TO-PEAK OUTPUT VOLTAGE vs. SUPPLY VOLTAGE FOR ALL TYPES

3  
OPERATIONAL  
AMPLIFIERS

CA741C, CA741, CA1458, CA1558, LM741, LM741C, LM1458, LM1558

T-79-05-10

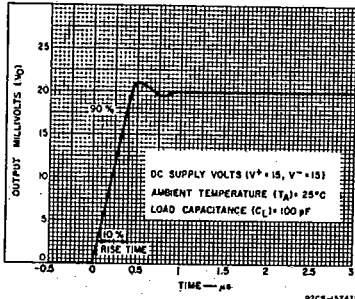

FIGURE 5. OUTPUT VOLTAGE vs. TRANSIENT RESPONSE TIME FOR CA741C AND CA741

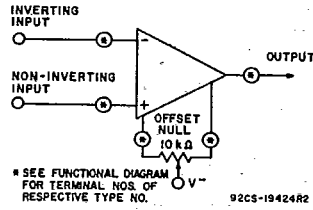

FIGURE 6. VOLTAGE OFFSET NULL CIRCUIT FOR CA741C AND CA741

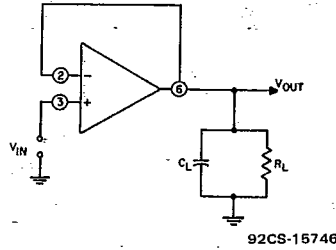
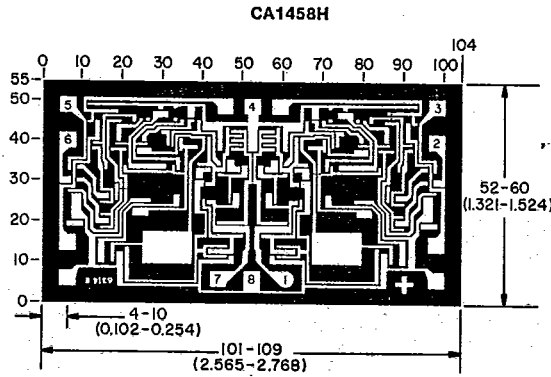
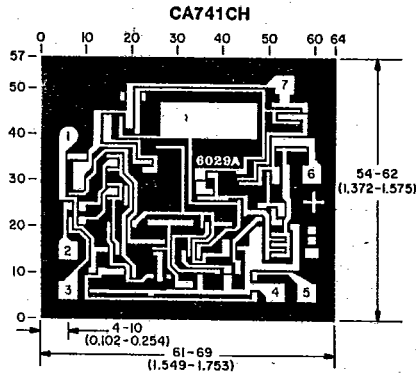

FIGURE 7. TRANSIENT RESPONSE TEST CIRCUIT FOR ALL TYPES

Chip Photos

DIMENSIONS AND PAD LAYOUTS



NOTE: Dimensions in parentheses are in millimeters and are derived from the basic inch dimensions as indicated. Grid graduations are in mils (10<sup>-3</sup> inch).