



# CHENMKO ENTERPRISE CO.,LTD

**CHN10PT**

## SURFACE MOUNT SWITCHING DIODE

VOLTAGE 80 Volts CURRENT 100 mAmpere

*Lead free devices*

### APPLICATION

- \* Ultra high speed switching

### FEATURE

- \* Small surface mounting type. (SC-74/SOT-457)
- \* Multiple diodes in one small surface mount package.
- \* Suitable for high packing density.
- \* Maximum total power dissipation is 300mW.
- \* Peak forward current is 300mA.

### CONSTRUCTION

- \* Silicon epitaxial planar

### MARKING

- \* D1P



SC-74/SOT-457

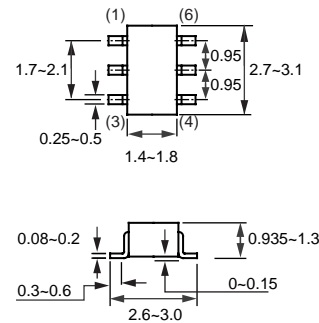

Dimensions in millimeters

SC-74/SOT-457

### CIRCUIT

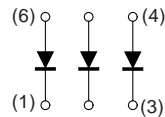

### MAXIMUM RATINGS ( At TA = 25°C unless otherwise noted )

RATINGS	SYMBOL	CHN10PT	UNITS
Maximum Recurrent Peak Reverse Voltage	VRRM	80	Volts
Maximum RMS Voltage	VRMS	56	Volts
Maximum DC Blocking Voltage	VDC	80	Volts
Maximum Average Forward Rectified Current	Io	100	mAmps
Peak Forward Surge Current at 1uSec.	IFSM	4.0	Amps
Typical Junction Capacitance between Terminal (Note 1)	CJ	3.5	pF
Maximum Reverse Recovery Time (Note 2)	TRR	4.0	nSec
Maximum Operating Temperature Range	TJ	+150	°C
Storage Temperature Range	TSTG	-55 to +150	°C

### ELECTRICAL CHARACTERISTICS ( At TA = 25°C unless otherwise noted )

CHARACTERISTICS	SYMBOL	CHN10PT	UNITS
Maximum Instantaneous Forward Voltage at If= 100mA	VF	1.20	Volts
Maximum Average Reverse Current at VR= 70V	IR	0.1	uAmps

- NOTES : 1. Measured at 1.0 MHz and applied reverse voltage of 6.0 volts.  
 2. Measured at applied forward current of 5mA and reverse voltage of 6.0 volts.  
 3. ESD sensitive product handling required.

2001-10

## RATING CHARACTERISTIC CURVES ( CHN10PT )

FIG. 1 - POWER DERATING CURVE

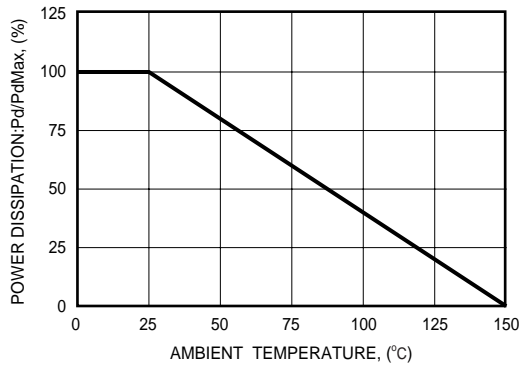

FIG. 2 - FORWARD CHARACTERISTICS

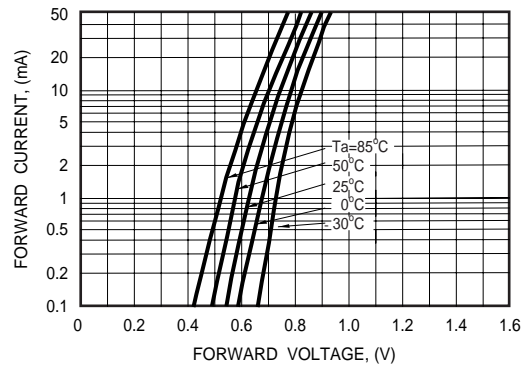

FIG. 3 - TYPICAL JUNCTION CAPACITANCE

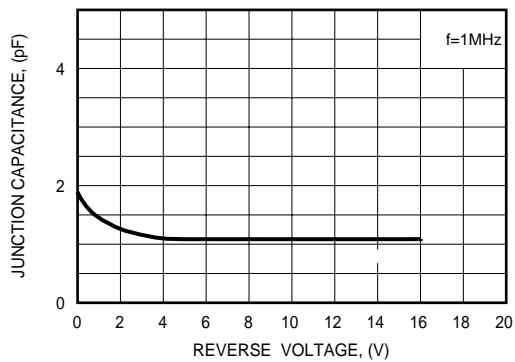

FIG. 4 - REVERSE CHARACTERISTICS

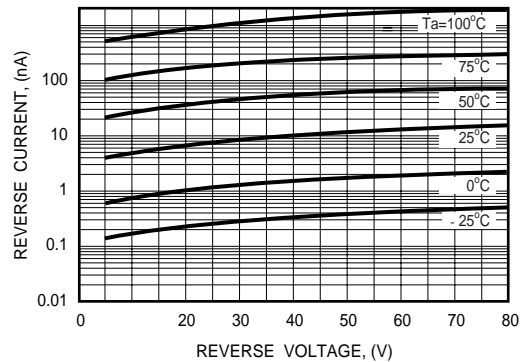

FIG. 5 - REVERSE RECOVERY TIME

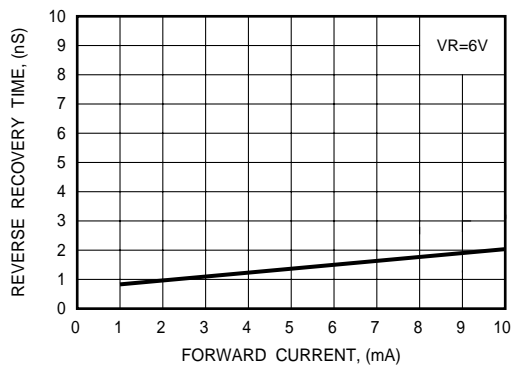

FIG. 6 - REVERSE RECOVERY TIME MEASUREMENT CIRCUIT

