



4 and 8-Channel EMI Filter Arrays with ESD Protection

CM1406

Features

- Four and eight channels of EMI filtering with ESD protection
- Greater than 30dB of attenuation from 800MHz to 3GHz
- 15kV ESD protection (IEC 61000-4-2, contact discharge)
- 30kV ESD protection (HBM)
- Fabricated with *Centurion*™ advanced low capacitance zener process technology
- Space saving, low-profile 8 and 16-lead TDFN packages
- Lead-free and RoHS compliant

Applications

- I/O port protection for mobile handsets, notebook computers, PDAs etc.
- EMI filtering for data ports in cell phones, PDAs or notebook computers.
- EMI filtering for LCD, camera and chip-to-chip data lines

Product Description

The CM1406 is an EMI filter array with ESD protection, which integrates either four or eight pi filters (C-R-C). Each CM1406 filter has component values of 15pF-200W-15pF. These parts include ESD protection diodes on every pin, providing a very high level of protection for sensitive electronic components that may be subjected to electrostatic discharge (ESD). The ESD diodes connected to the filter ports safely dissipate ESD strikes of •15kV contact discharge, twice the specification requirement of the IEC 61000-4-2, Level 4 international standard. Using the MIL-STD-883 (Method 3015) specification for Human Body Model (HBM) ESD, the pins are protected for contact discharges at greater than •30kV.

This device is particularly well suited for portable electronics (e.g. mobile handsets, PDAs, notebook computers) because of its small package and easy-to-use pin assignments. In particular, the CM1406 is ideal for EMI filtering and protecting data lines from ESD in wireless handsets.

The CM1406 is available in space-saving, low-profile, 8-lead and 16-lead TDFN packages. It is fabricated with *Centurion*™ process and available with lead-free finishing.

Block Diagram

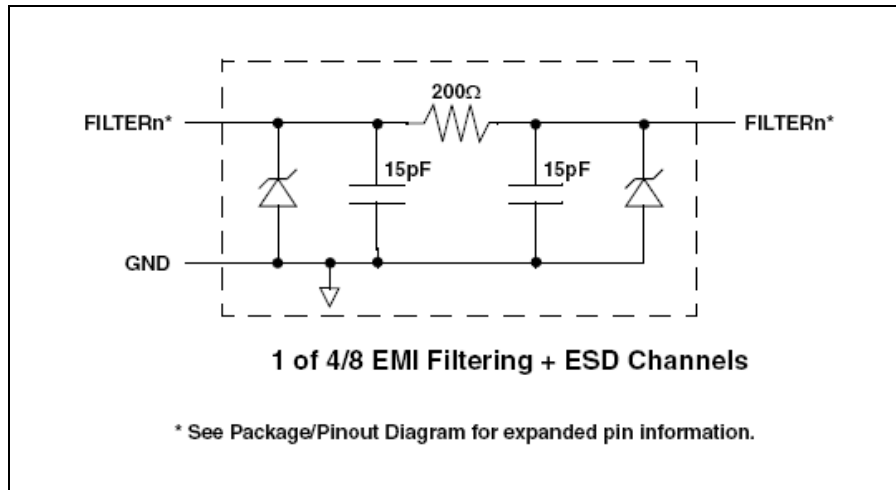

PACKAGE / PINOUT DIAGRAMS

CM1406-04DE
8-Lead TDFN Package

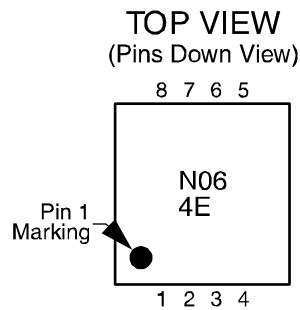

BOTTOM VIEW
(Pins Up View)

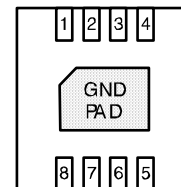

CM1406-08DE
16-Lead TDFN Package

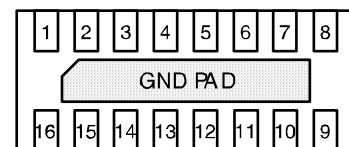
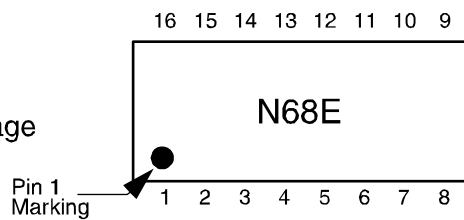

Notes:

- 1) This drawing is not to scale.

CM1406

PIN DESCRIPTIONS

Pins		NAME	DESCRIPTION	Pins		NAME	DESCRIPTION
1406-04Dx	1406-08Dx			1406-04Dx	1406-08Dx		
1	1	FILTER1	Filter Channel 1	8	16	FILTER1	Filter Channel 1
2	2	FILTER2	Filter Channel 2	7	15	FILTER2	Filter Channel 2
3	3	FILTER3	Filter Channel 3	6	14	FILTER3	Filter Channel 3
4	4	FILTER4	Filter Channel 4	5	13	FILTER4	Filter Channel 4
	5	FILTER5	Filter Channel 5		12	FILTER5	Filter Channel 5
	6	FILTER6	Filter Channel 6		11	FILTER6	Filter Channel 6
	7	FILTER7	Filter Channel 7		10	FILTER7	Filter Channel 7
	8	FILTER8	Filter Channel 8		9	FILTER8	Filter Channel 8
GND Pad		GND	Device Ground				

Ordering Information

PART NUMBERING INFORMATION

Leads/Pins	Package	Lead-free Finish	
		Ordering Part Number ¹	Part Marking
8	TDFN-08	CM1406-04DE	N06 4E
16	TDFN-16EEP	CM1406-08DE	N68E

Note 1: Parts are shipped in Tape & Reel form unless otherwise specified.

Specifications

ABSOLUTE MAXIMUM RATINGS

PARAMETER	RATING	UNITS
Storage Temperature Range	-65 to +150	°C
DC Power per Resistor	100	mW
Package DC Power Rating	300	mW

STANDARD OPERATING CONDITIONS

PARAMETER	RATING	UNITS
Operating Temperature Range	-40 to +85	°C

ELECTRICAL OPERATING CHARACTERISTICS (SEE NOTE 1)

SYMBOL	PARAMETER	CONDITIONS	MIN	TYP	MAX	UNITS
R	Resistance		160	200	240	Ω
C	Capacitance	At 2.5V DC, 1MHz, 30mV AC	12	15	18	pF
V _{DIODE}	Diode Standoff Voltage	I _{DIODE} = 10μA		6.0		V
I _{LEAK}	Diode Leakage Current (reverse bias)	V _{DIODE} = 3.3V		0.1	1	μA
V _{SIG}	Signal Voltage Positive Clamp Negative Clamp	I _{LOAD} = 10mA I _{LOAD} = -10mA	5.6 -1.5	6.8 -0.8	9.0 -0.4	V V
V _{ESD}	In-system ESD Withstand Voltage a) Human Body Model, MIL-STD-883, Method 3015 b) Contact Discharge per IEC 61000-4-2 Level 4	Note 2	30			kV kV
f _C	Cut-off Frequency Z _{SOURCE} =50Ω, Z _{LOAD} =50Ω	R = 200Ω, C = 15pF;		105		MHz

Note 1: T_A=25°C unless otherwise specified.

Note 2: ESD applied to input and output pins with respect to GND, one at a time.

Performance Information

Typical Filter Performance (nominal conditions unless specified otherwise, 0V DC Bias, 50 Ohm Environment)

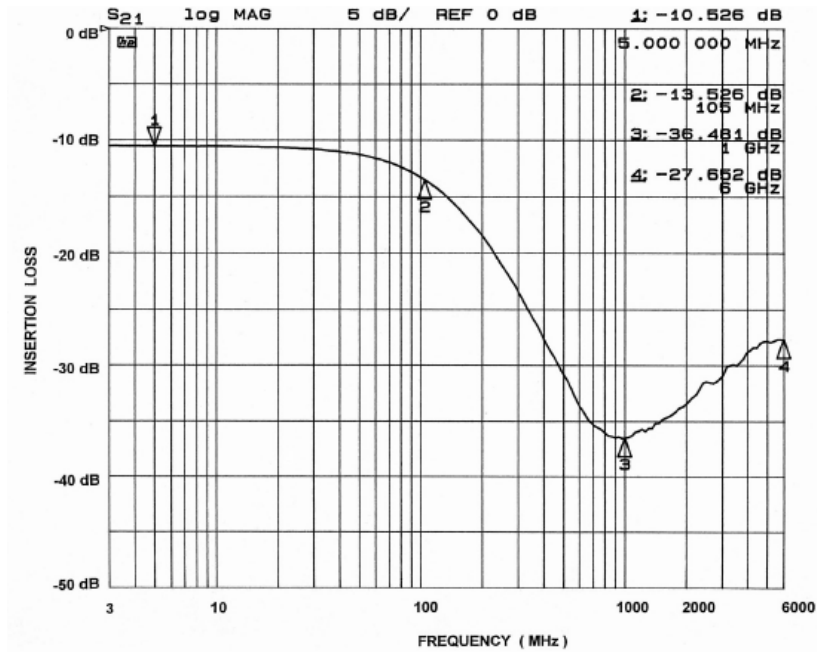

Figure 1. Channel 1 EMI Filter Performance (CM1406-04 only)

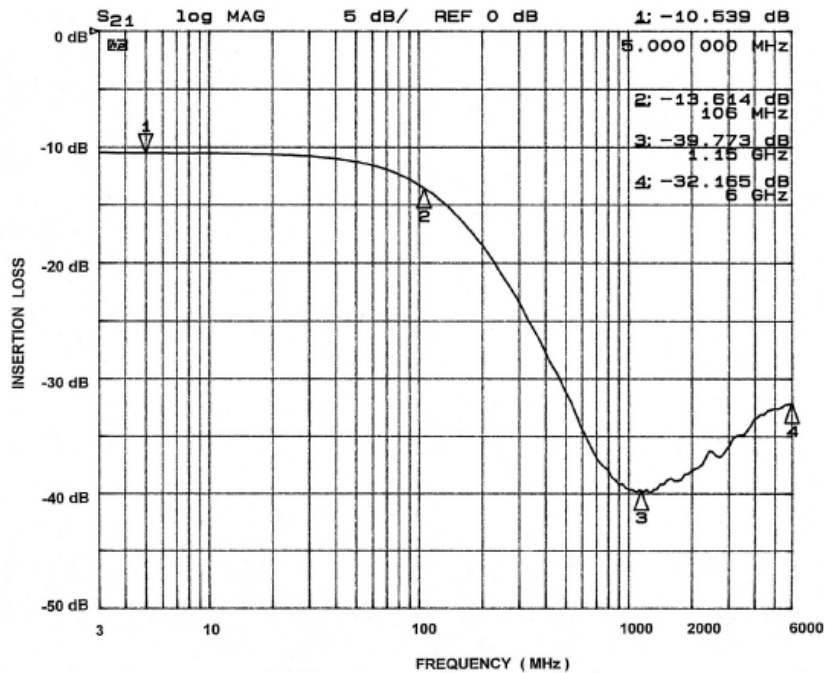

Figure 2. Channel 2 EMI Filter Performance (CM1406-04 only)

Performance Information (cont'd)

Typical Filter Performance (nominal conditions unless specified otherwise, 0V DC Bias, 50 Ohm Environment)

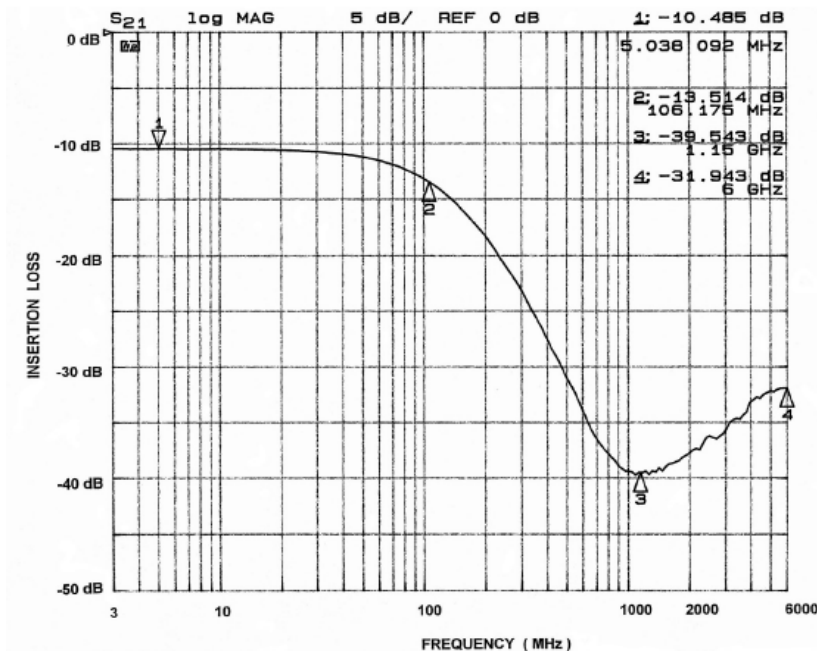

Figure 3. Channel 3 EMI Filter Performance (CM1406-04 only)

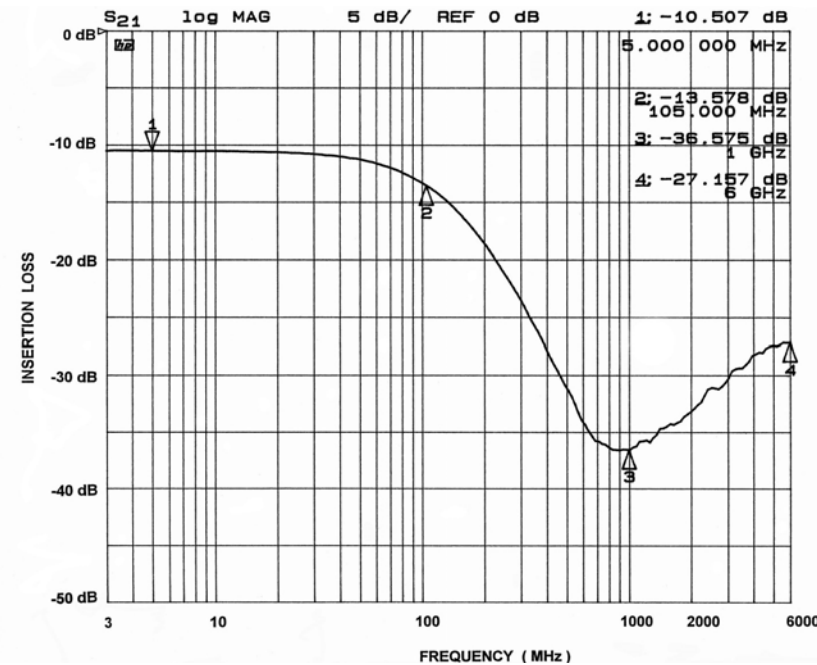

Figure 4. Channel 4 EMI Filter Performance (CM1406-04 only)

Performance Information (cont'd)

Typical Filter Performance (nominal conditions unless specified otherwise, 0V DC Bias, 50 Ohm Environment)

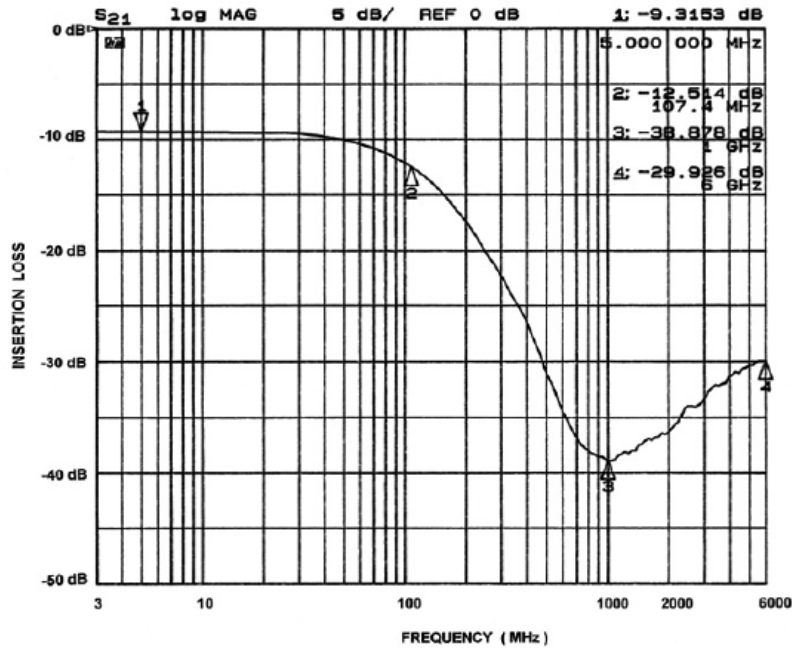

Figure 5. Channel 1 EMI Filter Performance (CM1406-08 only)

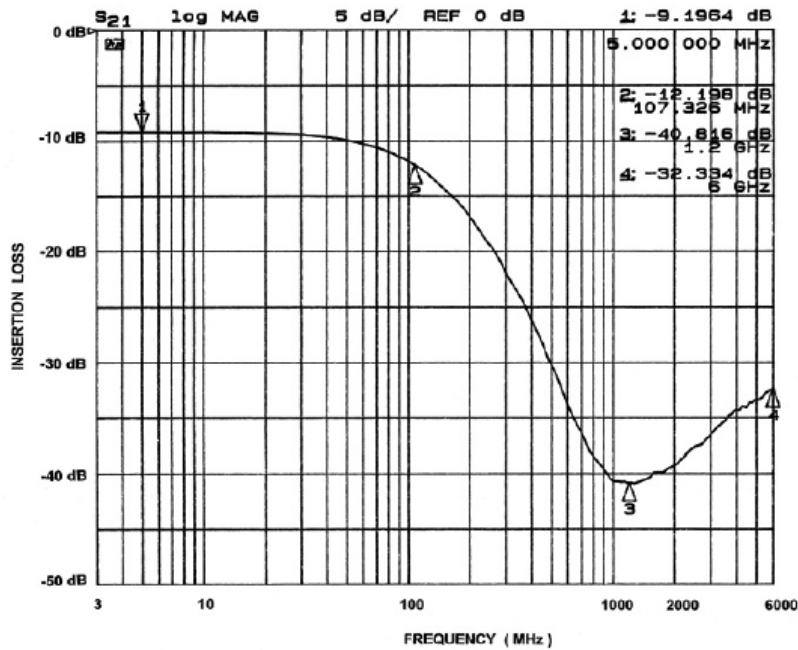

Figure 6. Channel 2 EMI Filter Performance (CM1406-08 only)

Performance Information (cont'd)

Typical Filter Performance (nominal conditions unless specified otherwise, 0V DC Bias, 50 Ohm Environment)

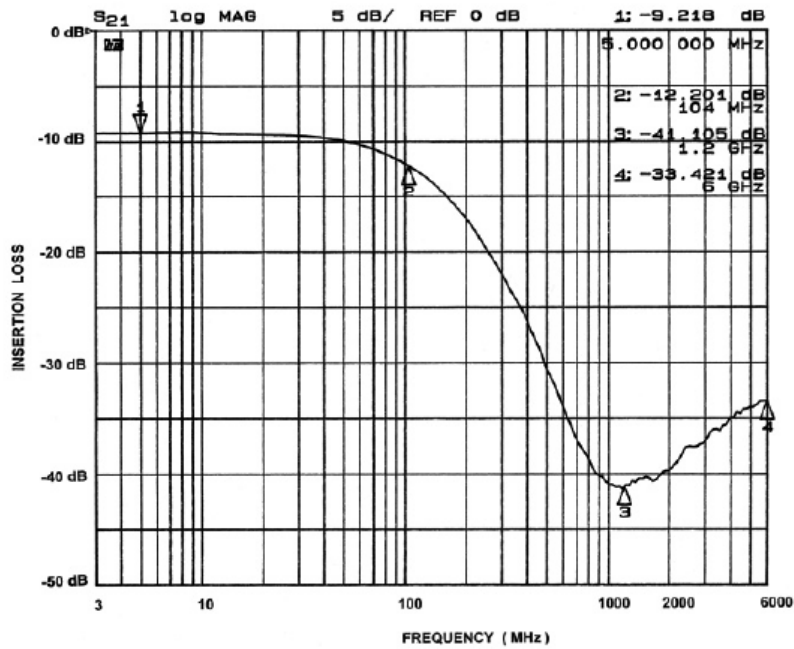

Figure 7. Channel 3 EMI Filter Performance (CM1406-08 only)

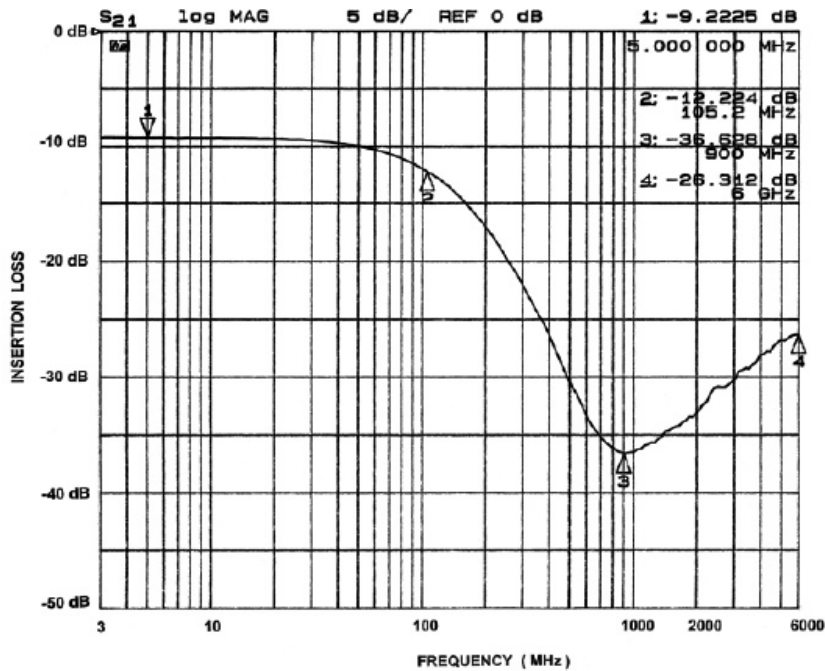

Figure 8. Channel 4 EMI Filter Performance (CM1406-08 only)

Performance Information (cont'd)

Typical Filter Performance (nominal conditions unless specified otherwise, 0V DC Bias, 50 Ohm Environment)

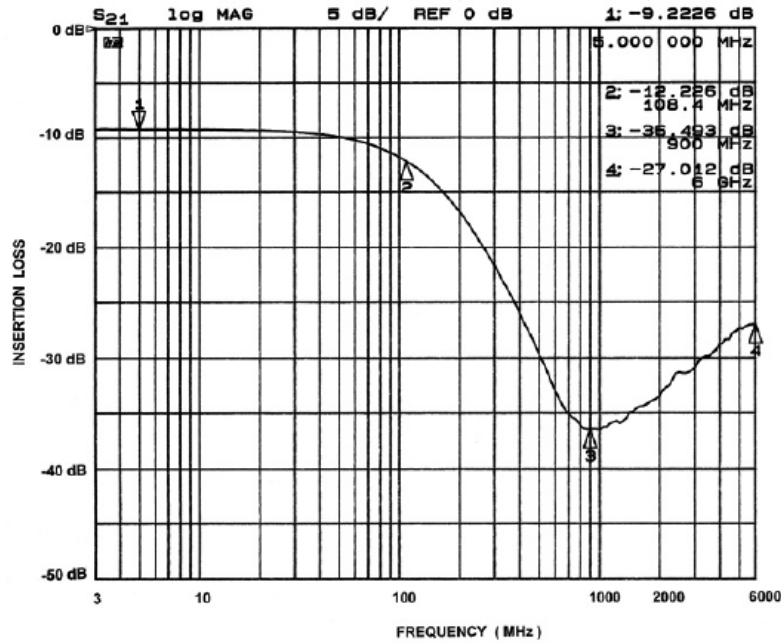

Figure 9. Channel 5 EMI Filter Performance (CM1406-08 only)

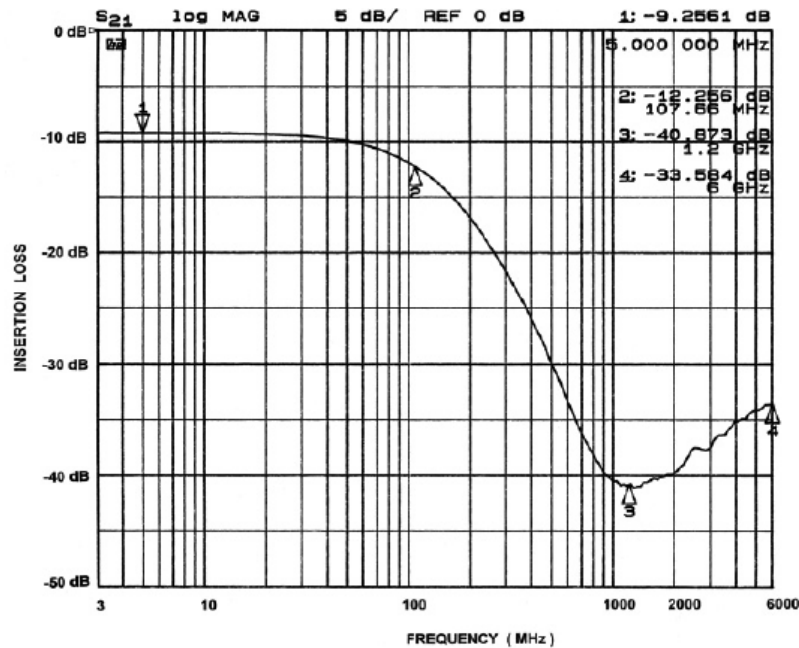

Figure 10. Channel 6 EMI Filter Performance (CM1406-08 only)

Performance Information (cont'd)

Typical Filter Performance (nominal conditions unless specified otherwise, 0V DC Bias, 50 Ohm Environment)

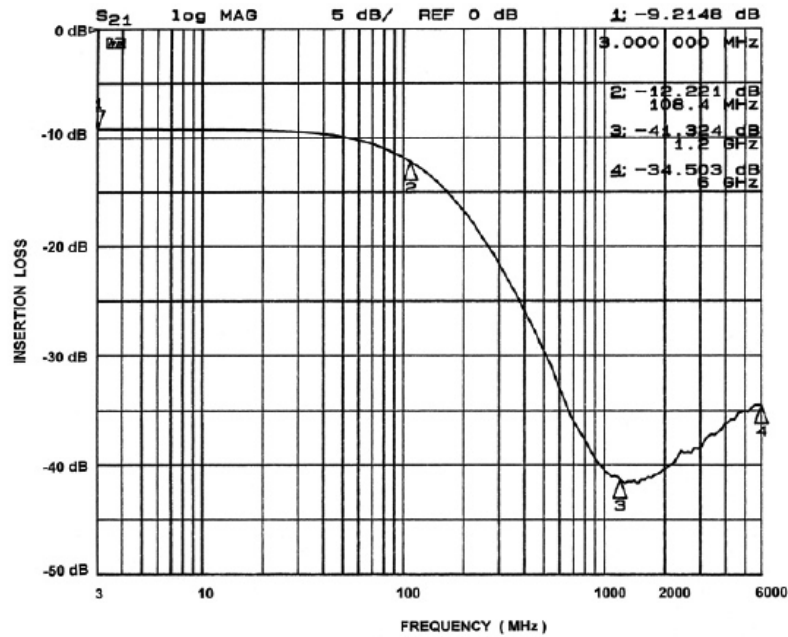

Figure 11. Channel 7 EMI Filter Performance (CM1406-08 only)

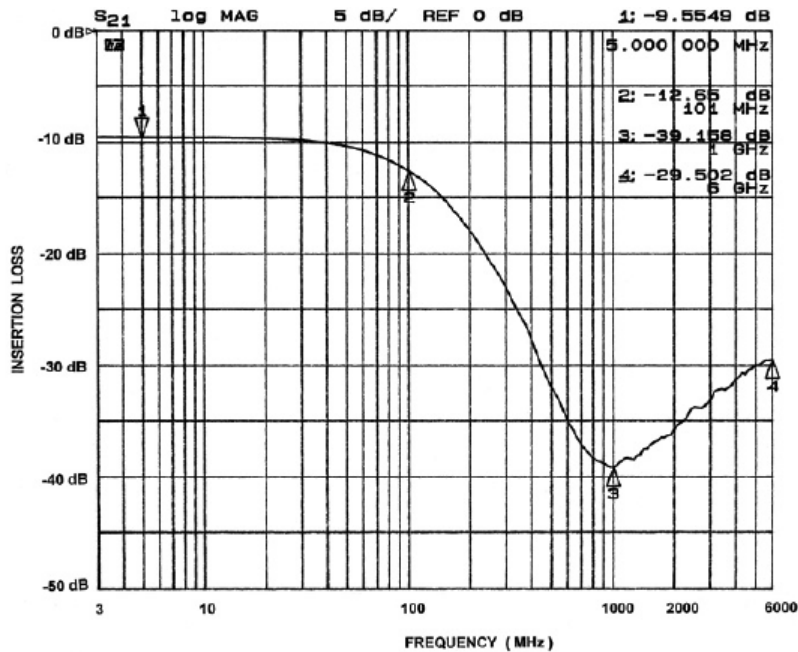

Figure 12. Channel 8 EMI Filter Performance (CM1406-08 only)

Performance Information (cont'd)

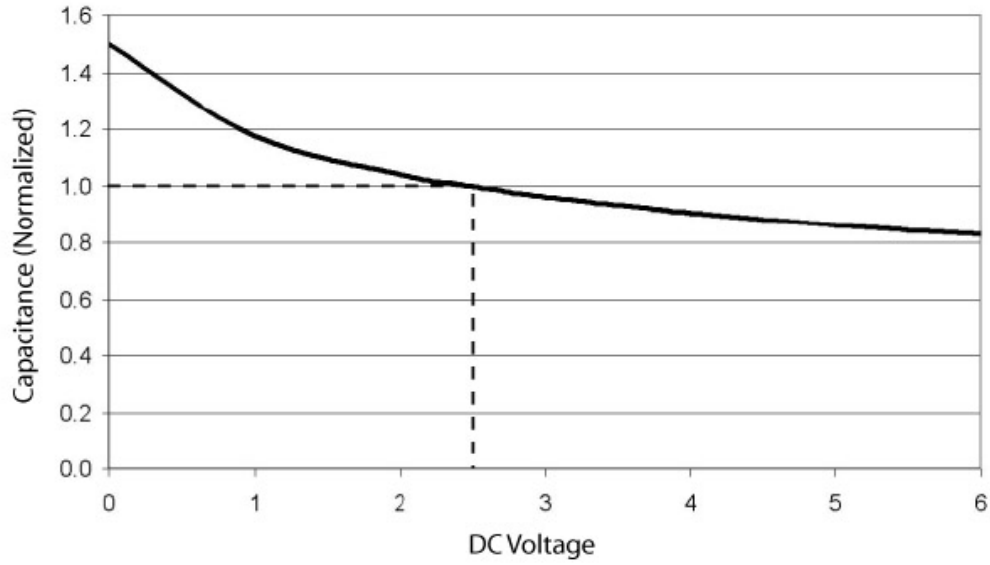

Figure 13. Filter Capacitance vs. Input Voltage over Temperature (normalized to capacitance at 2.5VDC and 25°C)

Mechanical Details

TDFN-08 Mechanical Specifications, 0.5mm

The CM1406 is supplied in an 8-lead 0.5mm TDFN package. Dimensions are presented below.

PACKAGE DIMENSIONS						
Package	TDFN					
JEDEC No.	MO-229 (Var. VCCD-3)*					
Leads	8					
Dim.	Millimeters			Inches		
	Min	Nom	Max	Min	Nom	Max
A	0.70	0.75	0.80	0.028	0.030	0.031
A3	0.20 REF			0.008 REF		
b	0.20	0.25	0.30	0.008	0.010	0.012
D	1.90	2.00	2.10	0.075	0.079	0.083
D2	1.50	1.60	1.70	0.059	0.063	0.067
E	1.90	2.00	2.10	0.075	0.079	0.083
E2	0.80	0.90	1.00	0.031	0.035	0.039
e	0.50 BSC			0.020 BSC		
K	0.20			0.008		
L	0.20	0.30	0.40	0.008	0.012	0.016
# per tape and reel	3000 pieces					
Controlling dimension: millimeters						

*This package is compliant with JEDEC standard MO-229, variation VCCD-3 with exception of the D2 and E2 dimensions as called out in the table above and the r1 dimension which is not specified in the MO-229 standard.

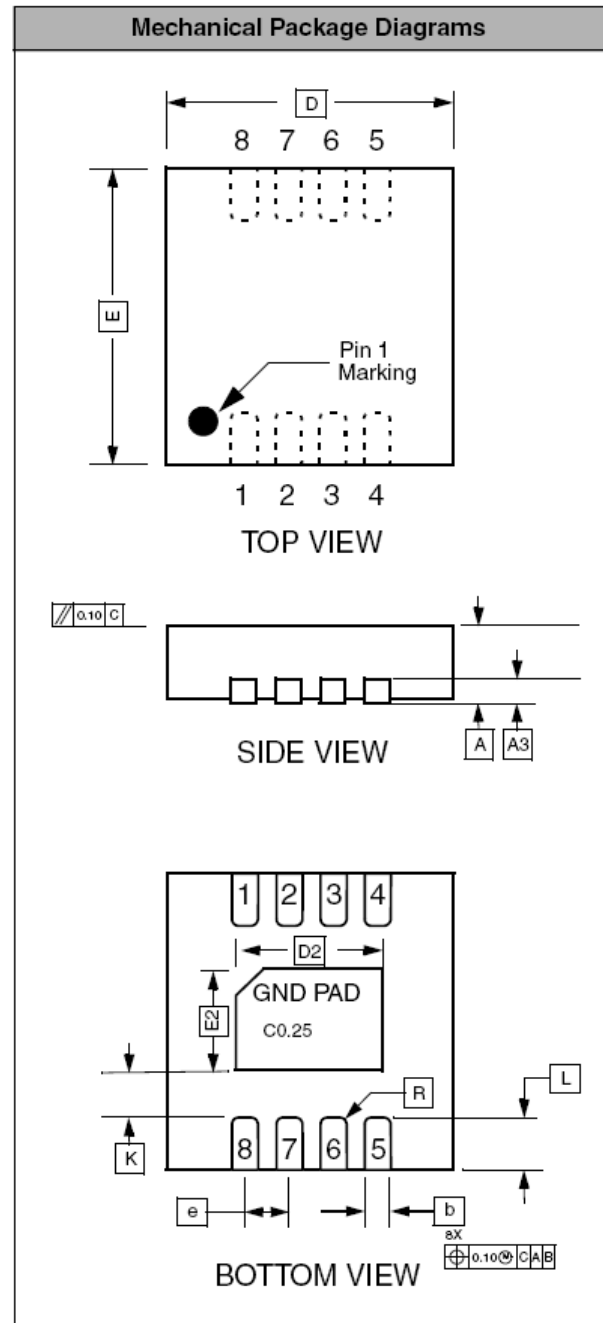

**Dimensions for 8-Lead,
0.5mm pitch TDFN package**

CM1406

Mechanical Details (Cont'd)

TDFN-16EEP Mechanical Specifications, 0.5mm

The CM1406 is supplied in a 16-lead, 0.5mm pitch TDFN package with Exposed End Pads (EEP). Dimension are presented below.

PACKAGE DIMENSIONS						
Package	TDFN					
JEDEC No.	MO-229C*					
Leads	16					
Dim.	Millimeters			Inches		
	Min	Nom	Max	Min	Nom	Max
A	0.70	0.75	0.80	0.028	0.030	0.031
A1	0.00	0.02	0.05	0.000	0.001	0.002
A3	0.20 REF			0.008 REF		
b	0.20	0.25	0.30	0.008	0.010	0.012
D	3.90	4.00	4.10	0.153	0.157	0.161
D2	3.10	3.20	3.30	0.122	0.126	0.130
E	1.50	1.60	1.70	0.059	0.063	0.067
E2	0.30	0.40	0.50	0.012	0.016	0.020
e	0.50 BSC			0.020 BSC		
K	0.20			0.008		
L	0.20	0.30	0.40	0.008	0.010	0.012
M	0.25 REF			0.010 REF		
# per tape and reel	3000 pieces					
Controlling dimension: millimeters						

*This package is compliant with JEDEC standard MO-229C with the exception of the D, D2, E, E2, K and L dimensions as called out in the table above.

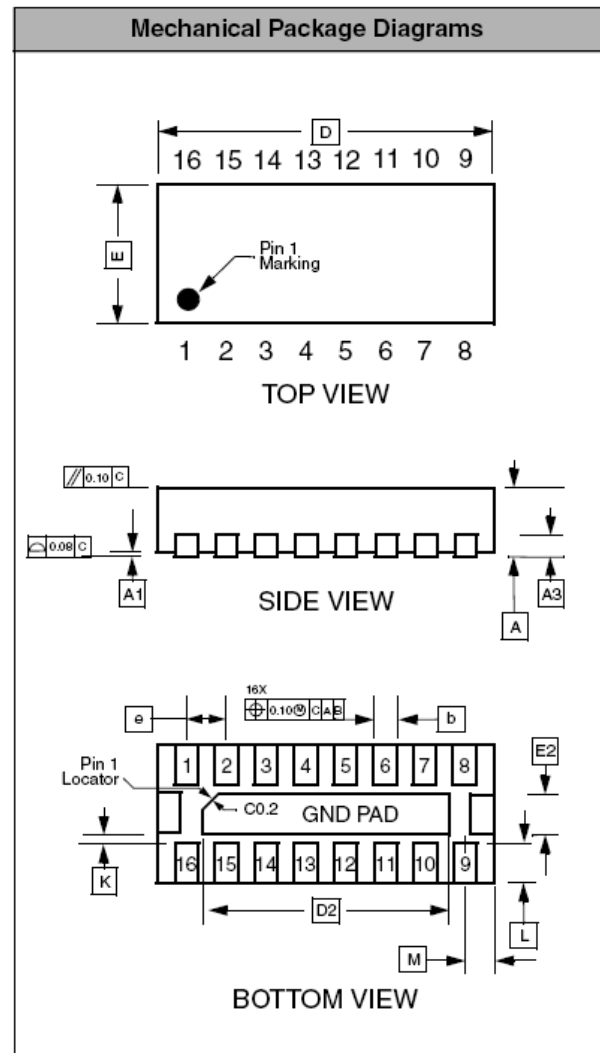

Dimensions for 16-Lead, 0.5mm pitch TDFN package with Exposed End Pads (EEP)

ON Semiconductor and  are registered trademarks of Semiconductor Components Industries, LLC (SCILLC). SCILLC reserves the right to make changes without further notice to any products herein. SCILLC makes no warranty, representation or guarantee regarding the suitability of its products for any particular purpose, nor does SCILLC assume any liability arising out of the application or use of any product or circuit, and specifically disclaims any and all liability, including without limitation special, consequential or incidental damages. "Typical" parameters which may be provided in SCILLC data sheets and/or specifications can and do vary in different applications and actual performance may vary over time. All operating parameters, including "Typicals" must be validated for each customer application by customer's technical experts. SCILLC does not convey any license under its patent rights nor the rights of others. SCILLC products are not designed, intended, or authorized for use as components in systems intended for surgical implant into the body, or other applications intended to support or sustain life, or for any other application in which the failure of the SCILLC product could create a situation where personal injury or death may occur. Should Buyer purchase or use SCILLC products for any such unintended or unauthorized application, Buyer shall indemnify and hold SCILLC and its officers, employees, subsidiaries, affiliates, and distributors harmless against all claims, costs, damages, and expenses, and reasonable attorney fees arising out of, directly or indirectly, any claim of personal injury or death associated with such unintended or unauthorized use, even if such claim alleges that SCILLC was negligent regarding the design or manufacture of the part. SCILLC is an Equal Opportunity/Affirmative Action Employer. This literature is subject to all applicable copyright laws and is not for resale in any manner.

PUBLICATION ORDERING INFORMATION

LITERATURE FULFILLMENT:

Literature Distribution Center for ON Semiconductor
P.O. Box 5163, Denver, Colorado 80217 USA
Phone: 303-675-2175 or 800-344-3860 Toll Free USA/Canada
Fax: 303-675-2176 or 800-344-3867 Toll Free USA/Canada
Email: orderlit@onsemi.com

N. American Technical Support: 800-282-9855
Toll Free USA/Canada
Europe, Middle East and Africa Technical Support:
Phone: 421 33 790 2910
Japan Customer Focus Center
Phone: 81-3-5773-3850

ON Semiconductor Website: www.onsemi.com

Order Literature: <http://www.onsemi.com/orderlit>

For additional information, please contact your local Sales Representative