



Secure Digital (SD) Card EMI Filter Array with ESD Protection

CM1423

Features

- Provides EMI filtering and ESD protection for an SD port on a mobile device
- Six channels of EMI filtering with ESD protection
- Four channels of ESD protection
- $\pm 15\text{kV}$ ESD protection on all I/O pins (IEC 61000-4-2, contact discharge)
- $\pm 30\text{kV}$ ESD protection (HBM)
- Better than 25dB of attenuation at 1GHz for 12pF-100 Ω -12pF filter configuration
- Integrates 34 components into small form factor CSP solution
- 20-bump, 4.000mm x 1.458mm footprint Chip Scale Package
- Chip Scale Package features extremely low lead inductance for optimum filter and ESD performance
- Available with *OptiGuard*[™] coating for improved reliability at assembly
- RoHS compliant (lead-free) finishing

Applications

- Secure Digital (SD) card data lines in mobile handsets
- SD card interface protection for other mobile electronics such as MP3 players, PDAs and digital cameras
- I/O port protection for mobile handsets, notebook computers, PDAs etc.
- EMI filtering for data ports in cell phones, PDAs or notebook computers.

Product Description

The CM1423 is an EMI filter array with ESD protection, which integrates six Pi- filters (C-R-C) and four channels of ESD protection. The CM1423's filters have component values of 12pF-100 Ω -12pF. The part includes ESD protection diodes on every pin, which provide a very high level of protection for sensitive electronic components that may be subjected to electrostatic discharge (ESD). All the ESD diodes safely dissipate ESD strikes of $\pm 15\text{kV}$, beyond the maximum requirement of the IEC 61000-4-2 international standard. Using the MIL-STD-883 (Method 3015) specification for Human Body Model (HBM) ESD, the pins are protected for contact discharges at greater than $\pm 30\text{kV}$.

This device is particularly well-suited for portable electronics (e.g. mobile handsets, PDAs, notebook computers) because of its small package and easy-to-use pin assignments. In particular, the CM1423 is ideal for EMI filtering and protecting data lines from ESD for the Secure Digital (SD) Card interface slot in mobile handsets. The CM1423 is an all-inclusive solution for the SD card interface since its EMI filters provide the proper cut-off frequency to attenuate unwanted signals.

The CM1423 is manufactured in a space-saving, low-profile, chip-scale package, and is optionally available with *OptiGuard*[™] coating for improved reliability. It is available with RoHS compliant lead-free finishing.

Block Diagram

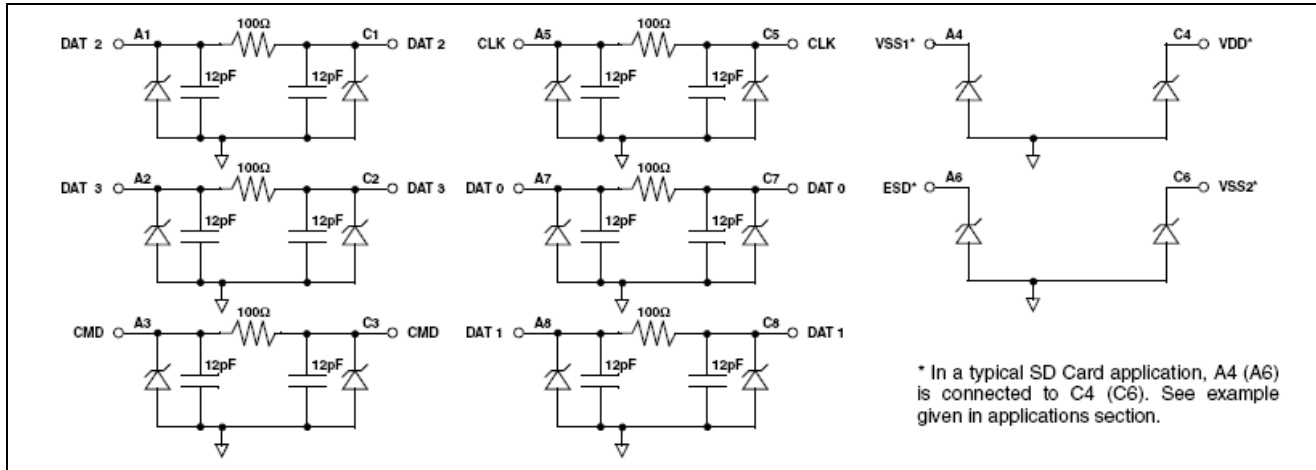

PACKAGE / PINOUT DIAGRAMS

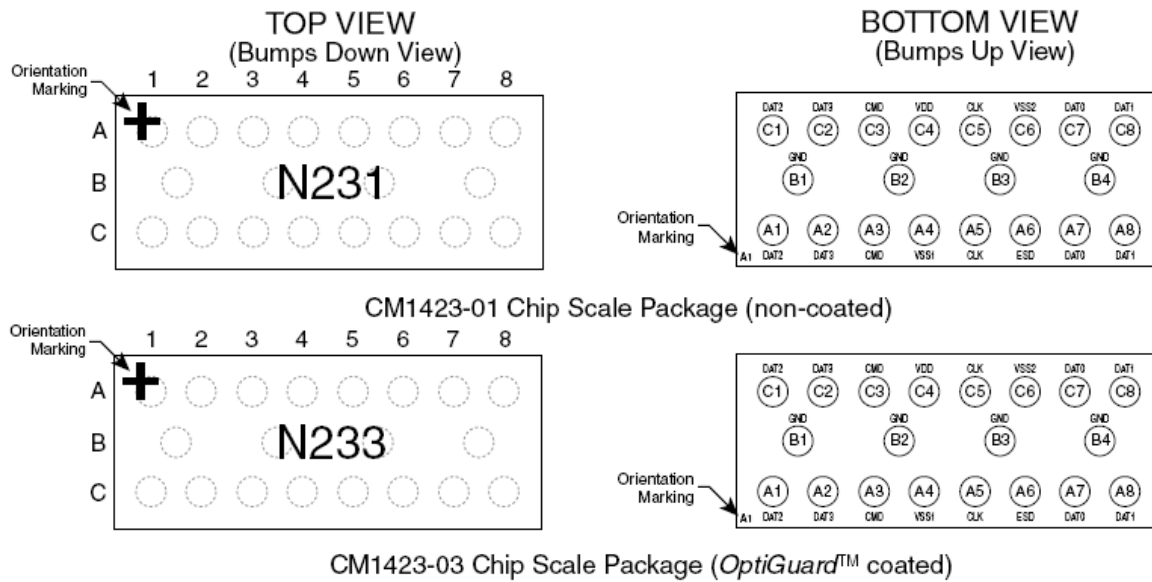

Notes:
1) These drawings are not to scale.

CM1423

PIN DESCRIPTIONS

PIN(s)	NAME	DESCRIPTION	PIN(s)	NAME	DESCRIPTION
A1	DAT2	DATA2 Filter+ESD Channel, System Side	C1	DAT2	DATA2 Filter+ ESD Channel, SD Card Side
A2	DAT3	DATA3 Filter+ESD Channel, System Side	C2	DAT3	DATA3 Filter+ ESD Channel, SD Card Side
A3	CMD	CMD Signal Filter+ESD Channel, System Side	C3	CMD	CMD Signal Filter+ESD Channel, SD Card Side
A4	VSS1	ESD-only Channel, Supply Voltage Ground	C4	VDD	ESD-only Channel, Supply Voltage
A5	CLK	Clock Filter + ESD Channel	C5	CLK	Clock Filter + ESD Channel
A6	ESD	ESD-only Channel	C6	VSS2	ESD-only Channel, Supply Voltage Ground
A7	DAT0	DATA0 Filter+ ESD Channel, System Side	C7	DAT0	DATA0 Filter+ ESD Channel, SD Card Side
A8	DAT1	DATA1 Filter+ ESD Channel, System Side	C8	DAT1	DATA1 Filter+ ESD Channel, SD Card Side
B1-B4	GND	Device Ground			

Ordering Information

PART NUMBERING INFORMATION

		-No Coating		OptiGuard™ Coated	
Bumps	PKG	Ordering Part Number ¹	Part Marking	Ordering Part Number ¹	Part Marking
20	CSP	CM1423-01CP	N231	CM1423-03CP	N233

Note 1: Parts are shipped in Tape and Reel form unless otherwise specified.

Specifications

ABSOLUTE MAXIMUM RATINGS

PARAMETER	RATING	UNITS
Storage Temperature Range	-65 to +150	°C
DC Power per Resistor	100	mW
DC Package Power Rating	500	mW

STANDARD OPERATING CONDITIONS

PARAMETER	RATING	UNITS
Operating Temperature Range	-40 to +85	°C

ELECTRICAL OPERATING CHARACTERISTICS (NOTE 1)

SYMBOL	PARAMETER	CONDITIONS	MIN	TYP	MAX	UNITS
R	Resistance		80	100	120	Ω
C	Capacitance	At 2.5V DC, 1MHz, 30mV AC	9	12	15	pF
V_{DIODE}	Diode Standoff Voltage	$I_{DIODE} = 10\mu A$		6.0		V
I_{LEAK}	Diode Leakage Current (reverse bias)	$V_{DIODE} = 3.3V$		100	300	nA
V_{SIG}	Signal Voltage Positive Clamp Negative Clamp	$I_{LOAD} = 10mA$ $I_{LOAD} = -10mA$	5.6 -1.5	6.8 -0.8	9.0 -0.4	V V
V_{ESD}	In-system ESD Withstand Voltage a) Human Body Model, MIL-STD-883, Method 3015 b) Contact Discharge per IEC 61000-4-2 Level 4	Note 2	± 30 ± 15			kV kV
R_{DYN}	Dynamic Resistance Positive Negative			1.6 0.4		Ω Ω
f_C	Cut-off Frequency $Z_{SOURCE} = 50\Omega, Z_{LOAD} = 50\Omega$	$R = 100\Omega, C = 12pF;$		145		MHz

Note 1: $T_A = 25^\circ C$ unless otherwise specified.

Note 2: ESD applied to input and output pins with respect to GND, one at a time.

Performance Information

Typical Filter Performance (nominal conditions unless specified otherwise, 50 Ohm Environment)

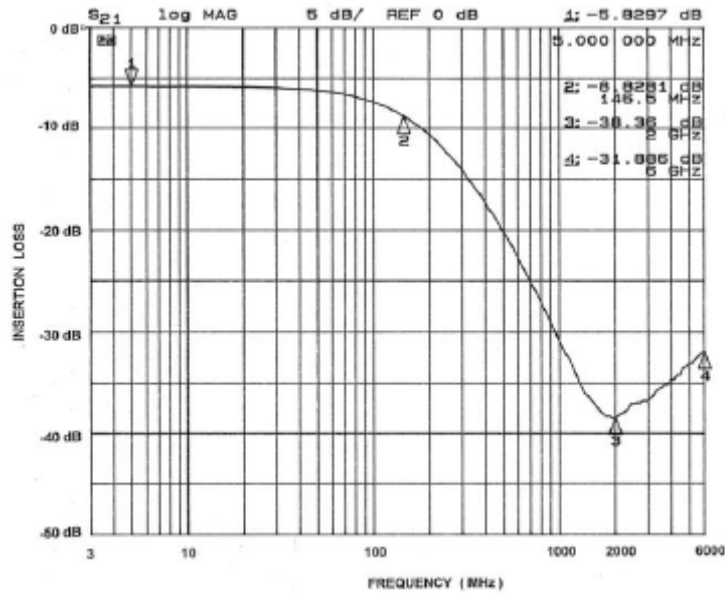

Figure 1. A1-C1 EMI Filter Performance

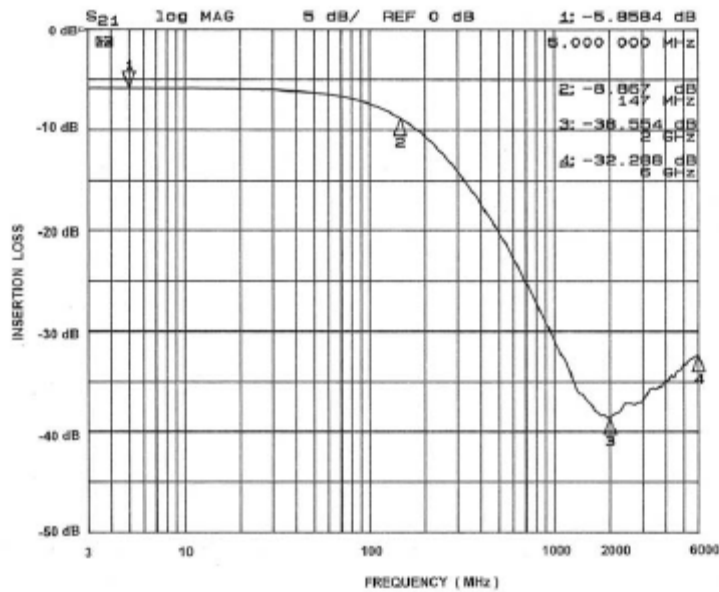

Figure 2. A2-C2 EMI Filter Performance

Performance Information (cont'd)

Typical Filter Performance (nominal conditions unless specified otherwise, 50 Ohm Environment)

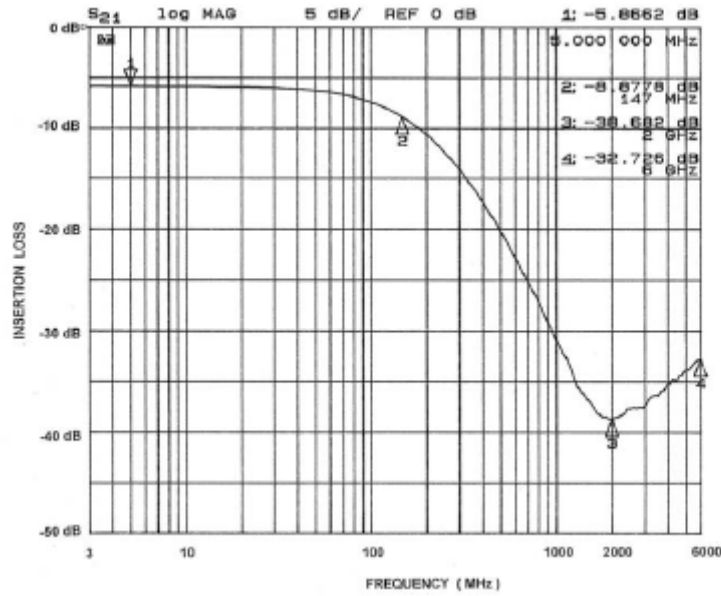

Figure 3. A3-C3 EMI Filter Performance

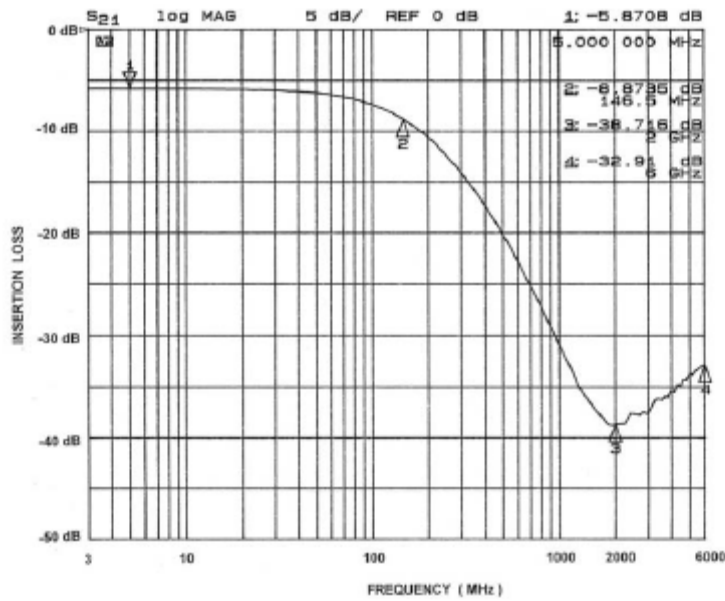

Figure 4. A5-C5 EMI Filter Performance

Performance Information (cont'd)

Typical Filter Performance (nominal conditions unless specified otherwise, 50 Ohm Environment)

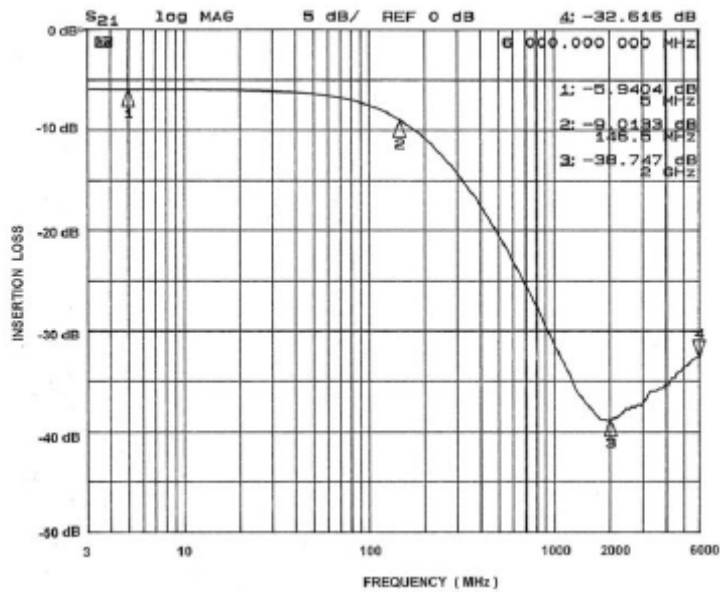

Figure 5. A7-C7 EMI Filter Performance

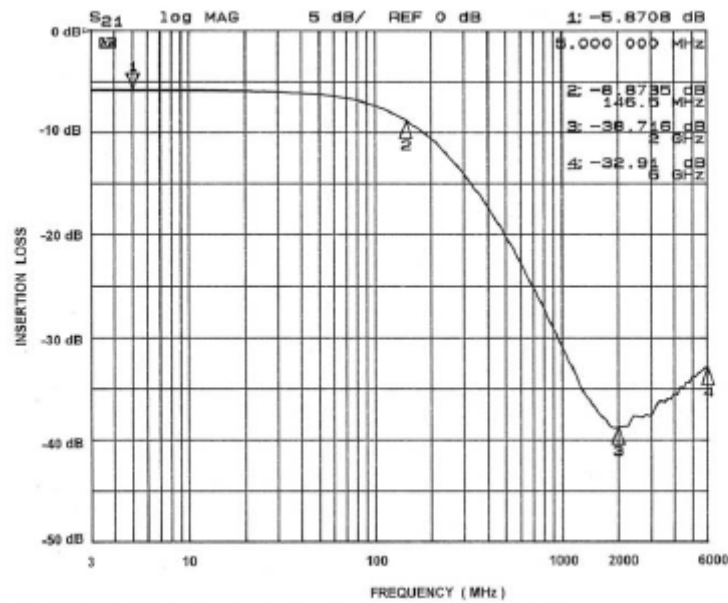

Figure 6. A8-C8 EMI Filter Performance

Performance Information

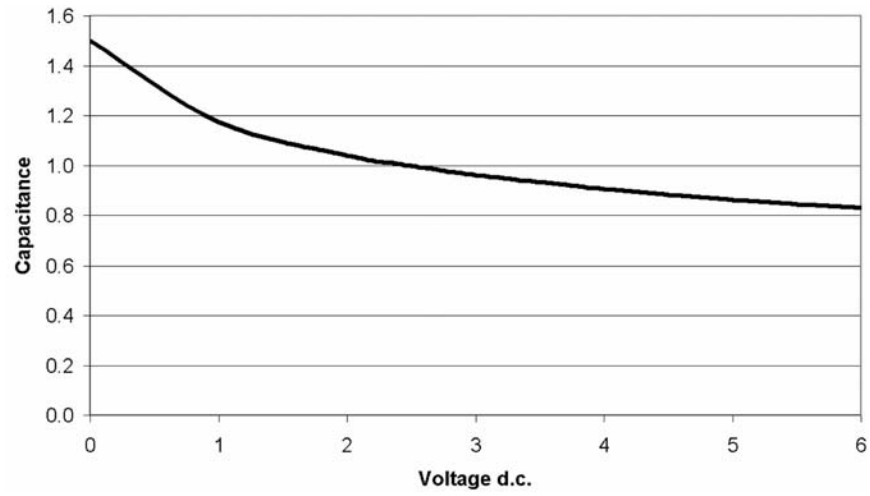

Figure 7. Filter Capacitance vs. Input Voltage over Temperature (normalized to capacitance at 2.5VDC and 25°C)

Application Information

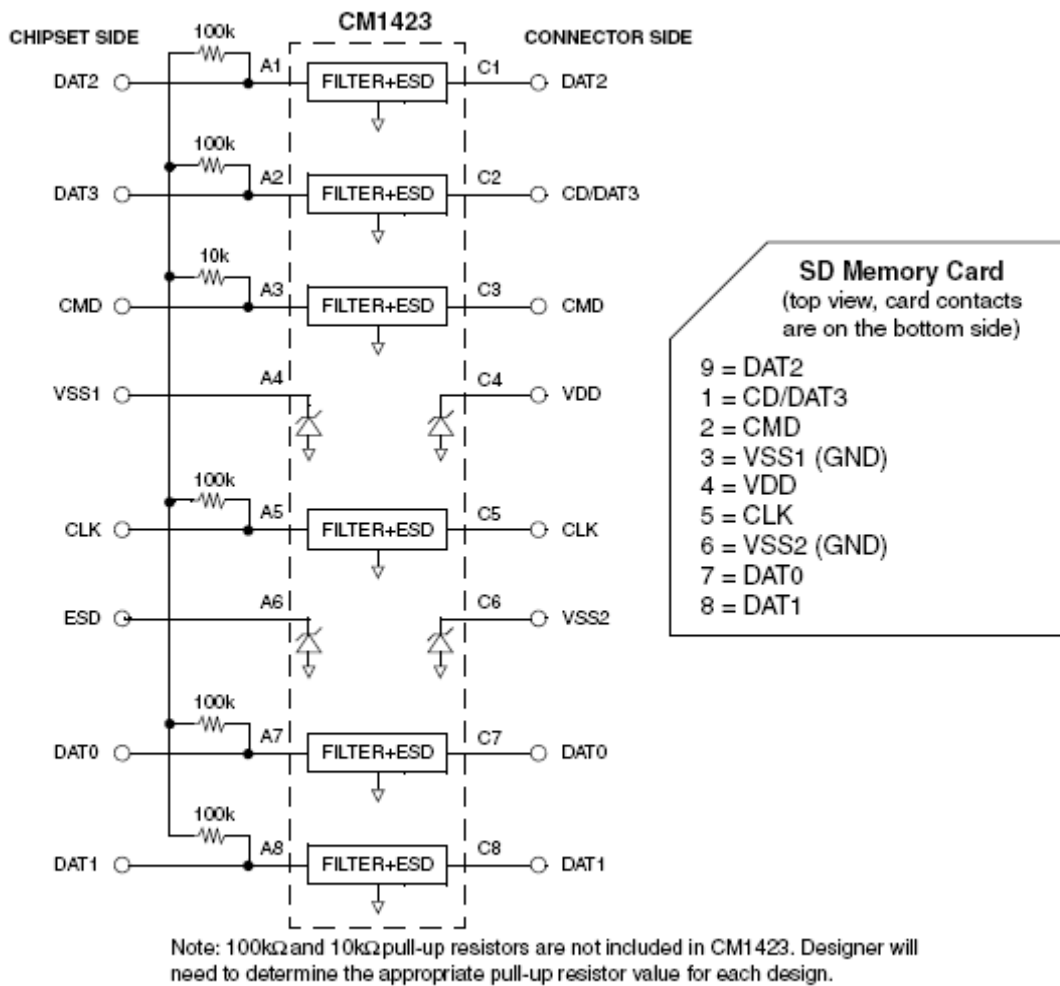

Figure 8. Typical SD Card Application

Application Information

PARAMETER	VALUE
Pad Size on PCB	0.240mm
Pad Shape	Round
Pad Definition	Non-Solder Mask defined pads
Solder Mask Opening	0.290mm Round
Solder Stencil Thickness	0.125mm - 0.150mm
Solder Stencil Aperture Opening (laser cut, 5% tapered walls)	0.300mm Round
Solder Flux Ratio	50/50 by volume
Solder Paste Type	No Clean
Pad Protective Finish	OSP (Entek Cu Plus 106A)
Tolerance — Edge To Corner Ball	$\pm 50\mu\text{m}$
Solder Ball Side Coplanarity	$\pm 20\mu\text{m}$
Maximum Dwell Time Above Liquidous	60 seconds
Maximum Soldering Temperature for Lead-free Devices using a Lead-free Solder Paste	260°C

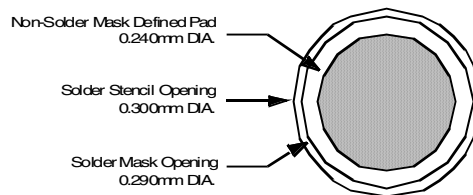

Figure 5. Recommended Non-Solder Mask Defined Pad Illustration

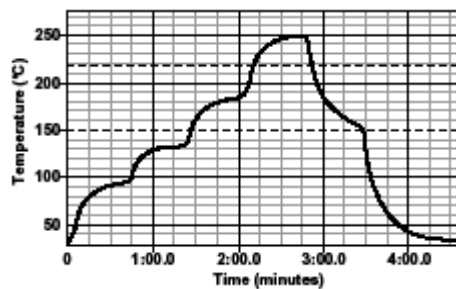

Figure 6. Lead-free (SnAgCu) Solder Ball Reflow Profile

Mechanical Details

CM1423 Mechanical Specifications

The package dimensions for the CM1423-01 and the CM1423-03 are presented below.

PACKAGE DIMENSIONS						
Package	Custom CSP					
Bumps	20					
Dim	Millimeters			Inches		
	Min	Nom	Max	Min	Nom	Max
A1	3.955	4.000	4.045	0.1557	0.1575	0.1593
A2	1.413	1.458	1.503	0.0556	0.0574	0.0592
B1	0.495	0.500	0.505	0.0195	0.0197	0.0199
B2	0.245	0.250	0.255	0.0096	0.0098	0.0100
B3	0.430	0.435	0.440	0.0169	0.0171	0.0173
B4	0.430	0.435	0.440	0.0169	0.0171	0.0173
C1	0.200	0.250	0.300	0.0079	0.0098	0.0118
C2	0.244	0.294	0.344	0.0096	0.0116	0.0135
D1	0.562	0.606	0.650	0.0221	0.0239	0.0256
D2	0.356	0.381	0.406	0.0140	0.0150	0.0160
D3	0.575	0.644	0.714	0.0226	0.0254	0.0281
D4	0.368	0.419	0.470	0.0145	0.0165	0.0185
# per tape and reel	3500 pieces					
Controlling dimension: millimeters						

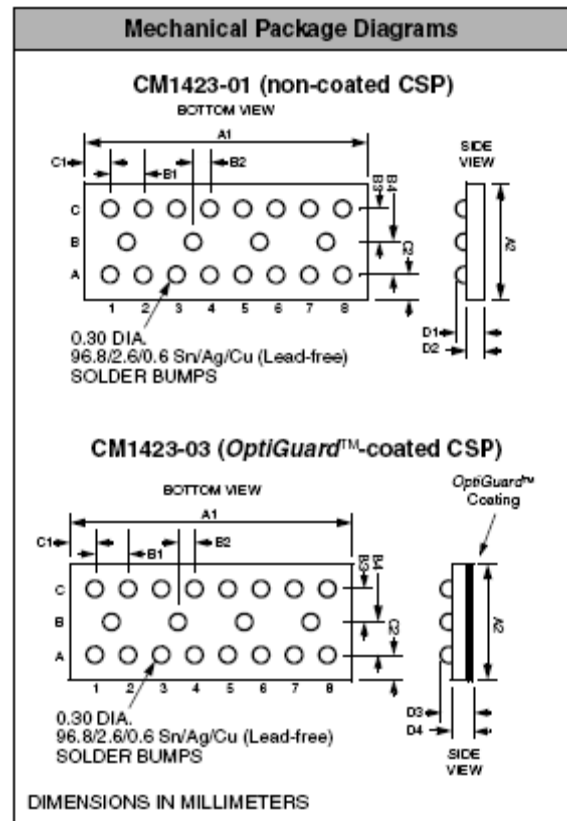

**Package Dimensions for CM1423
Chip Scale Package**

CM1423

CSP Tape and Reel Specifications

PART NUMBER	CHIP SIZE (mm)	POCKET SIZE (mm) $B_0 \times A_0 \times K_0$	TAPE WIDTH W	REEL DIAMETER	QTY PER REEL	P_0	P_1
CM1423-01	4.00 X 1.46 X 0.606	4.11 X 1.57 X 0.76	12mm	330mm (13")	3500	4mm	4mm
CM1423-03	4.00 X 1.46 X 0.644	4.11 X 1.57 X 0.76	12mm	330mm (13")	3500	4mm	4mm

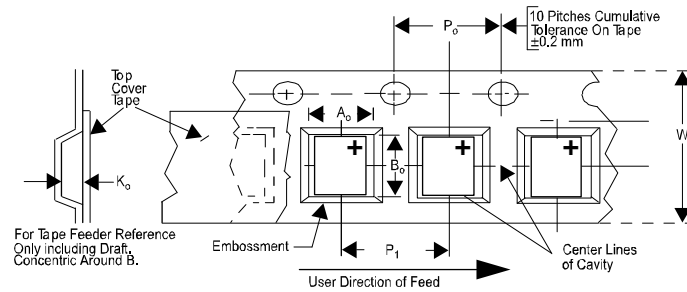



Figure 11. Tape and Reel Mechanical Data

ON Semiconductor and  are registered trademarks of Semiconductor Components Industries, LLC (SCILLC). SCILLC reserves the right to make changes without further notice to any products herein. SCILLC makes no warranty, representation or guarantee regarding the suitability of its products for any particular purpose, nor does SCILLC assume any liability arising out of the application or use of any product or circuit, and specifically disclaims any and all liability, including without limitation special, consequential or incidental damages. "Typical" parameters which may be provided in SCILLC data sheets and/or specifications can and do vary in different applications and actual performance may vary over time. All operating parameters, including "Typicals" must be validated for each customer application by customer's technical experts. SCILLC does not convey any license under its patent rights nor the rights of others. SCILLC products are not designed, intended, or authorized for use as components in systems intended for surgical implant into the body, or other applications intended to support or sustain life, or for any other application in which the failure of the SCILLC product could create a situation where personal injury or death may occur. Should Buyer purchase or use SCILLC products for any such unintended or unauthorized application, Buyer shall indemnify and hold SCILLC and its officers, employees, subsidiaries, affiliates, and distributors harmless against all claims, costs, damages, and expenses, and reasonable attorney fees arising out of, directly or indirectly, any claim of personal injury or death associated with such unintended or unauthorized use, even if such claim alleges that SCILLC was negligent regarding the design or manufacture of the part. SCILLC is an Equal Opportunity/Affirmative Action Employer. This literature is subject to all applicable copyright laws and is not for resale in any manner.

PUBLICATION ORDERING INFORMATION

LITERATURE FULFILLMENT:

Literature Distribution Center for ON Semiconductor
P.O. Box 5163, Denver, Colorado 80217 USA
Phone: 303-675-2175 or 800-344-3860 Toll Free USA/Canada
Fax: 303-675-2176 or 800-344-3867 Toll Free USA/Canada
Email: orderlit@onsemi.com

N. American Technical Support: 800-282-9855
Toll Free USA/Canada
Europe, Middle East and Africa Technical Support:
Phone: 421 33 790 2910
Japan Customer Focus Center
Phone: 81-3-5773-3850

ON Semiconductor Website: www.onsemi.com

Order Literature: <http://www.onsemi.com/orderlit>

For additional information, please contact your local Sales Representative