

CPDU5V0U

RoHS Device



Features

- Uni-directional ESD protection
- Working voltage:5V
- Surface mount package.
- High component density.

Mechanical data

- Case: 0603/SOD-523F standard package , molded plastic.
- Terminals: Gold plated, solderable per MIL-STD-750, method 2026.
- Marking Code: Cathode band & E05
- Mounting position: Any.
- Weight: 0.003 gram (approx.).

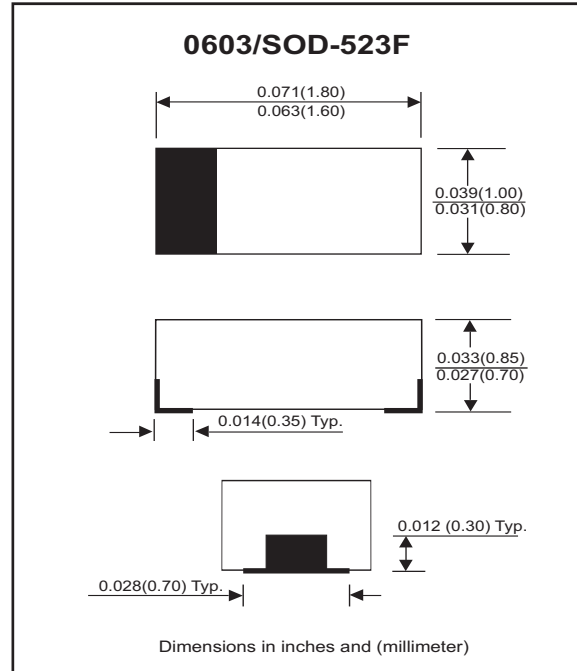

Maximum Rating AND Electrical Characteristics (at TA=25 °C unless otherwise noted)

Parameter	Conditions	Symbol	Min	Typ	Max	Unit
Forward voltage	I _F = 10mA	V _F		0.8		V
Diode breakdown voltage	I _R = 1mA	V _{BD}	6			V
Leakage current	V _R = 5V	I _L		0.3	2.0	uA
Junction capacitance	V _R = 0V, f = 1MHz	C _T		90	120	pF
ESD capability	IEC 61000-4-2(air) IEC 61000-4-2(contact)	ESD			20 15	kV
Clamping voltage	I _{PP} = 5A, T _P =8/20us I _{PP} = 16A, T _P =8/20us	V _C			9.8 12.5	V
Peak pulse power		P _{PP}			200	W
Operation temperature		T _J			125	°C
Storage temperature		T _{STG}	-55		150	°C

RATING AND CHARACTERISTIC CURVES (CPDU5V0U)

Fig. 1 - 8/20us Peak pulse current wave form acc. IEC 61000-4-5

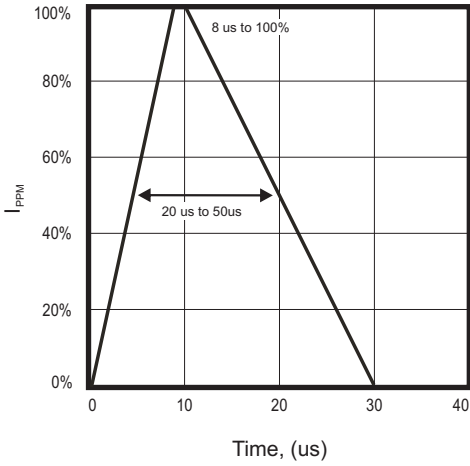

Fig. 2 - Power rating derating curve

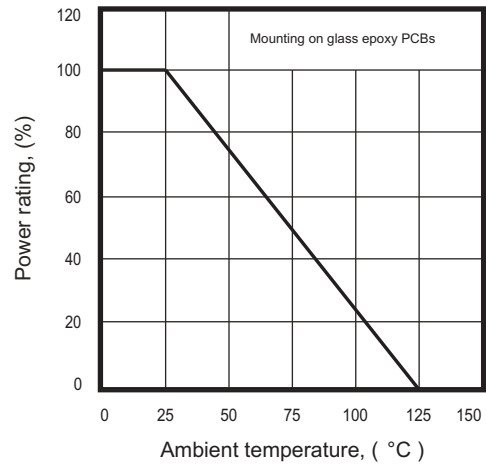

Fig. 3 - Clamping voltage vs. peak pulse current

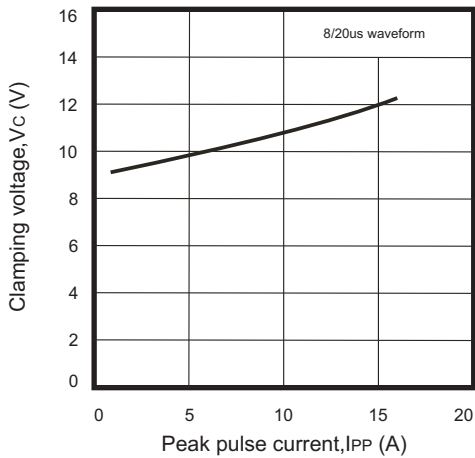

Fig. 4 - Forward voltage vs. forward current

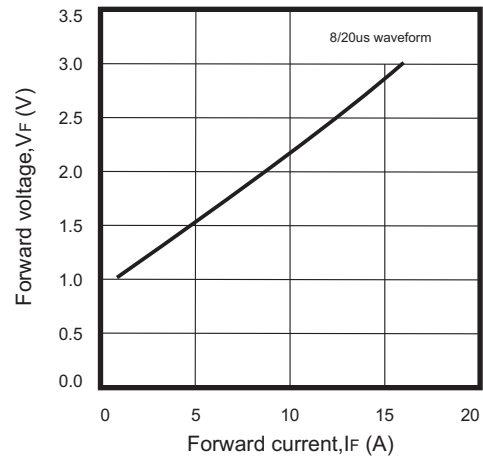

Fig. 5 - Capacitance between terminals characteristics

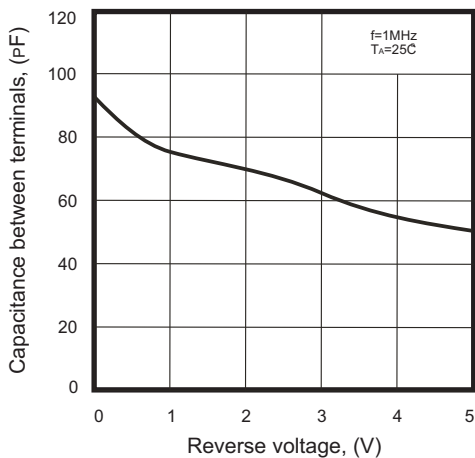
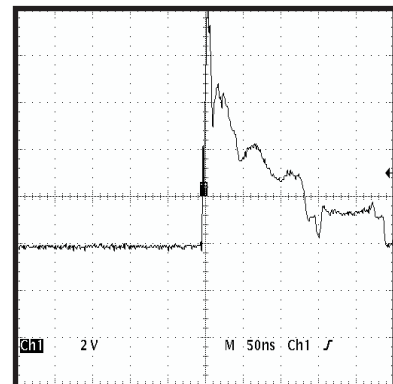
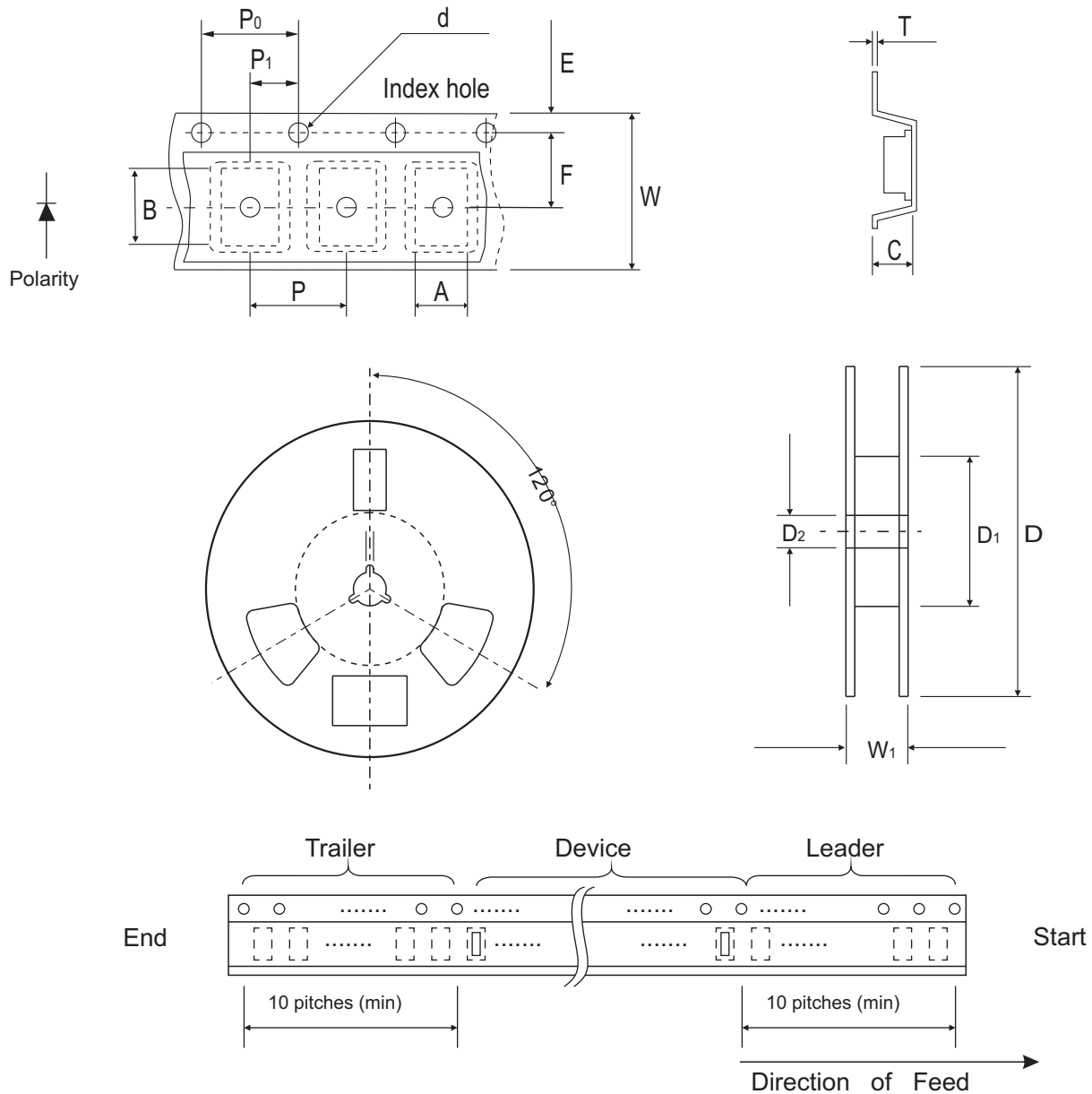

Fig. 6 - ESD Clamping (8kv Contant per IEC 61000-4-2)



Reel Taping Specification



0603 (SOD-523)	SYMBOL	A	B	C	d	D	D ₁	D ₂
	(mm)	1.00 ± 0.10	1.85 ± 0.10	1.00 ± 0.10	1.55 ± 0.05	178 ± 1	60.0 MIN.	13.0 ± 0.20
	(inch)	0.039 ± 0.004	0.073 ± 0.004	0.039 ± 0.004	0.061 ± 0.002	7.008 ± 0.04	2.362 MIN.	0.512 ± 0.008

0603 (SOD-523)	SYMBOL	E	F	P	P ₀	P ₁	T	W	W ₁
	(mm)	1.75 ± 0.10	3.50 ± 0.05	4.00 ± 0.10	4.00 ± 0.10	2.00 ± 0.05	0.23 ± 0.05	8.00 ± 0.20	13.5 MAX.
	(inch)	0.069 ± 0.004	0.138 ± 0.002	0.157 ± 0.004	0.157 ± 0.004	0.079 ± 0.004	0.009 ± 0.002	0.315 ± 0.008	0.531 MAX.

Marking Code

Part Number	Marking Code
CPDU5V0U	E05



Suggested PAD Layout

SIZE	0603/SOD-523F	
	(mm)	(inch)
A	1.70	0.067
B	0.60	0.024
C	0.80	0.031
D	2.30	0.091
E	1.10	0.043

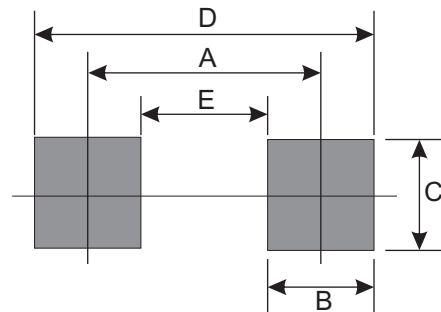

Standard Packaging

Case Type	Qty Per Reel	Reel Size
	(Pcs)	(inch)
0603/SOD-523F	4,000	7