

Features

- Very Sharp Breakdown Characteristics
- Very Tight Tolerance on V_Z
- Ideally Suited for Automated Assembly Processes
- Very Low Leakage Current
- **Lead Free By Design/RoHS Compliant (Note 5)**

Mechanical Data

- Case: SOD-323
- Case Material: Molded Plastic. UL Flammability Classification Rating 94V-0
- Moisture sensitivity: Level 1 per J-STD-020C
- Terminals: Finish - Matte Tin annealed over Alloy 42 leadframe. Solderable per MIL-STD-202, Method 208
- Polarity: Cathode Band
- Marking & Type Code Information: See Electrical Specifications Table
- Ordering Information: See Last Page
- Weight: 0.004 grams (approximate)

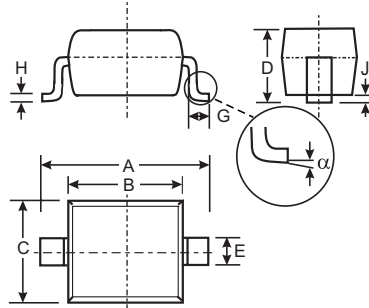

| SOD-323 | | |
|----------------------|--------------|------|
| Dim | Min | Max |
| A | 2.30 | 2.70 |
| B | 1.60 | 1.80 |
| C | 1.20 | 1.40 |
| D | 1.05 Typical | |
| E | 0.25 | 0.35 |
| G | 0.20 | 0.40 |
| H | 0.10 | 0.15 |
| J | 0.05 Typical | |
| α | 0° | 8° |
| All Dimensions in mm | | |

Maximum Ratings @ $T_A = 25^\circ\text{C}$ unless otherwise specified

| Characteristic | Symbol | Value | Unit |
|---|----------------|-------------|------------------|
| Forward Voltage @ $I_F = 10\text{mA}$ | V_F | 0.9 | V |
| Operating and Storage Temperature Range | T_j, T_{STG} | -65 to +150 | $^\circ\text{C}$ |

Thermal Characteristics @ $T_A = 25^\circ\text{C}$ unless otherwise specified

| Characteristic | Symbol | Value | Unit |
|--|-----------------|-------|--------------------|
| Power Dissipation (Note 1) | P_d | 200 | mW |
| Thermal Resistance, Junction to Ambient Air (Note 1) | $R_{\theta JA}$ | 625 | $^\circ\text{C/W}$ |

Notes: 1. Device mounted on FR-4 PC board with recommended pad layout, which can be found on our website at <http://www.diodes.com/datasheets/ap02001.pdf>.

| Type Number | Type Code | Zener Voltage Range (Note 2) | | | | Maximum Reverse Leakage Current (Note 3) | |
|-------------|-----------|------------------------------|---------|---------|---------------|--|------|
| | | $V_Z @ I_{ZT}$ | | | I_{ZT} | $I_R @ V_R$ | |
| | | Nom (V) | Min (V) | Max (V) | μA | μA | V |
| DDZ9689S | HH | 5.1 | 4.85 | 5.36 | 50 | 5 | 3 |
| DDZ9690S | HJ | 5.6 | 5.32 | 5.88 | 50 | 2 | 4 |
| DDZ9691S | HK | 6.2 | 5.89 | 6.51 | 50 | 1 | 5 |
| DDZ9692S | HL | 6.8 | 6.46 | 7.14 | 50 | 0.1 | 5.1 |
| DDZ9693S | HM | 7.5 | 7.13 | 7.88 | 50 | 0.1 | 5.7 |
| DDZ9694S | HN | 8.2 | 7.79 | 8.61 | 50 | 0.1 | 6.2 |
| DDZ9696S | HP | 9.1 | 8.65 | 9.56 | 50 | 0.1 | 6.9 |
| DDZ9697S | HQ | 10 | 9.50 | 10.50 | 50 | 0.1 | 7.6 |
| DDZ9698S | HR | 11 | 10.45 | 11.55 | 50 | 0.05 | 8.4 |
| DDZ9699S | HS | 12 | 11.40 | 12.60 | 50 | 0.05 | 9.1 |
| DDZ9700S | HT | 13 | 12.35 | 13.65 | 50 | 0.05 | 9.8 |
| DDZ9701S | HU | 14 | 13.30 | 14.70 | 50 | 0.05 | 10.6 |
| DDZ9702S | HV | 15 | 14.25 | 15.75 | 50 | 0.05 | 11.4 |
| DDZ9703S | HW | 16 | 15.20 | 16.80 | 50 | 0.05 | 12.1 |
| DDZ9705S | HY | 18 | 17.10 | 18.90 | 50 | 0.05 | 13.6 |
| DDZ9707S | MD | 20 | 19.00 | 21.00 | 50 | 0.05 | 15.2 |
| DDZ9708S | ME | 22 | 20.90 | 23.10 | 50 | 0.05 | 16.7 |
| DDZ9709S | MF | 24 | 22.80 | 25.20 | 50 | 0.05 | 18.2 |
| DDZ9711S | MH | 27 | 25.65 | 28.35 | 50 | 0.05 | 20.4 |
| DDZ9712S | MJ | 28 | 26.60 | 29.40 | 50 | 0.05 | 21.2 |
| DDZ9713S | MK | 30 | 28.50 | 31.50 | 50 | 0.05 | 22.8 |
| DDZ9714S | ML | 33 | 31.35 | 34.65 | 50 | 0.05 | 25.0 |
| DDZ9715S | MM | 36 | 34.20 | 37.80 | 50 | 0.05 | 27.3 |
| DDZ9716S | MN | 39 | 37.05 | 40.95 | 50 | 0.05 | 29.6 |
| DDZ9717S | MO | 43 | 40.85 | 45.15 | 50 | 0.05 | 32.6 |

- Notes:
2. Nominal Zener voltage is measured with the device junction in thermal equilibrium at $T_T = 30^\circ\text{C} \pm 1^\circ\text{C}$.
 3. Short duration pulse test used to minimize self-heating effect.

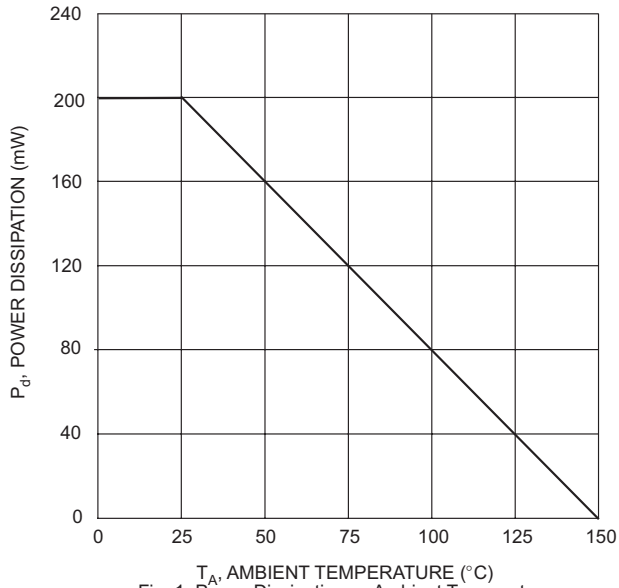

Fig. 1 Power Dissipation vs Ambient Temperature

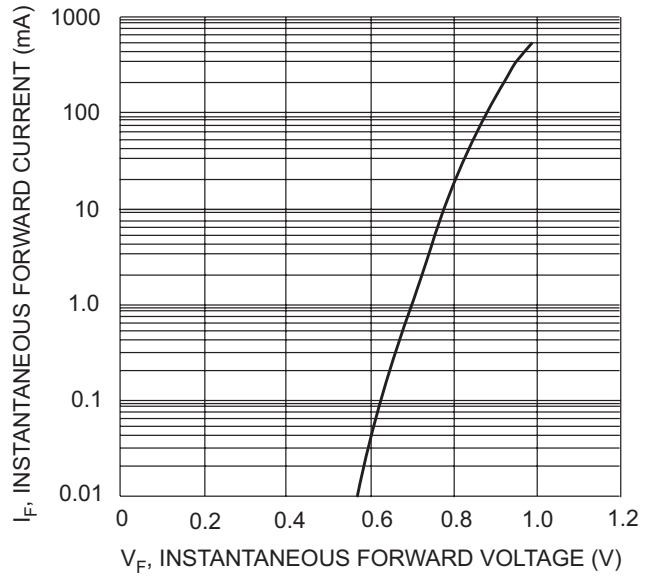

Fig. 2 Typical Forward Characteristics

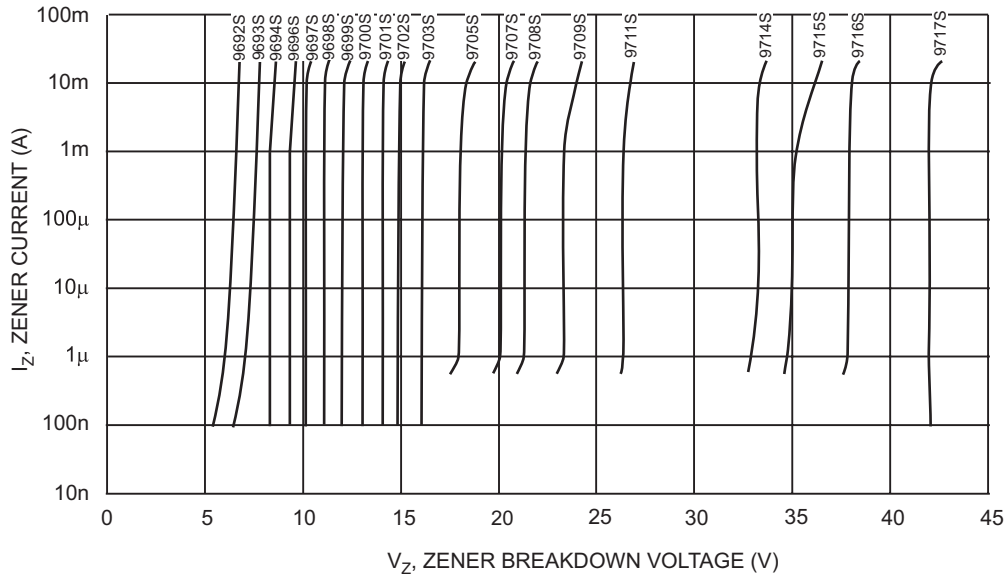

Fig. 3 Typical Reverse Characteristics

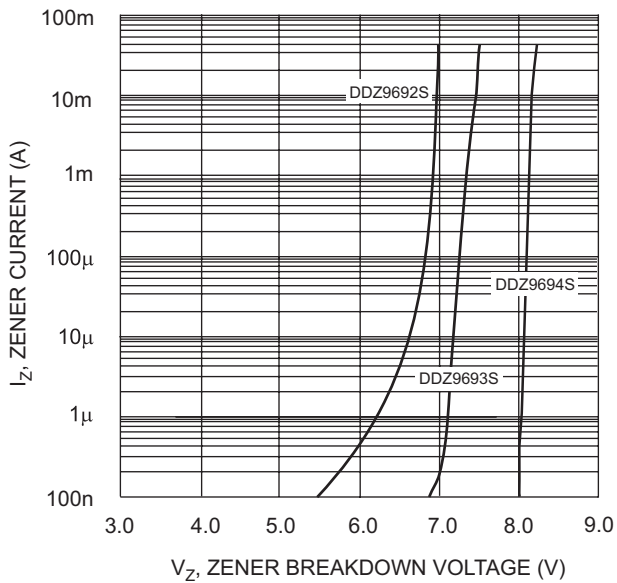

Fig. 4 Typical Reverse Characteristics, DDZ9692S - DDZ9694S

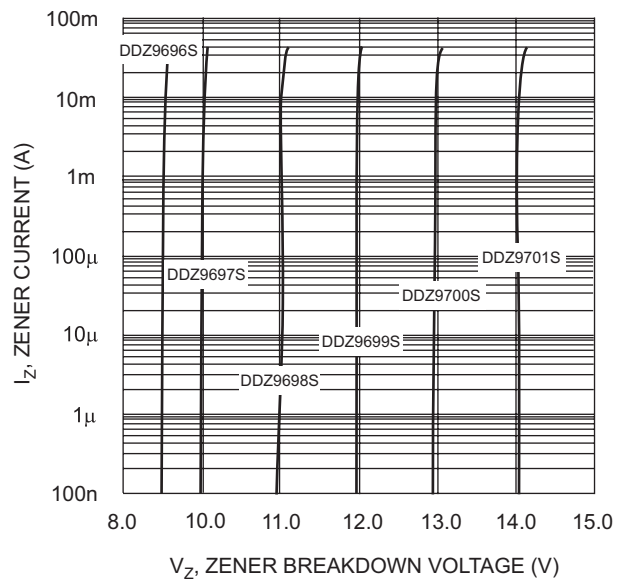

Fig. 5 Typical Reverse Characteristics, DDZ9696S - DDZ9701S

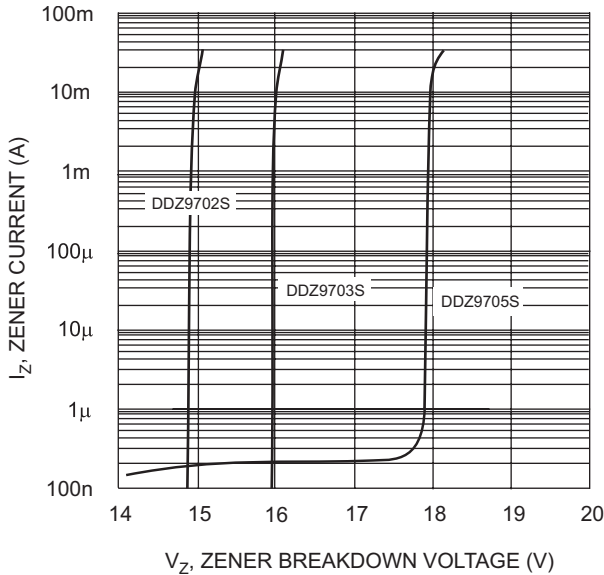

Fig. 6 Typical Reverse Characteristics, DDZ9702S - DDZ9705S

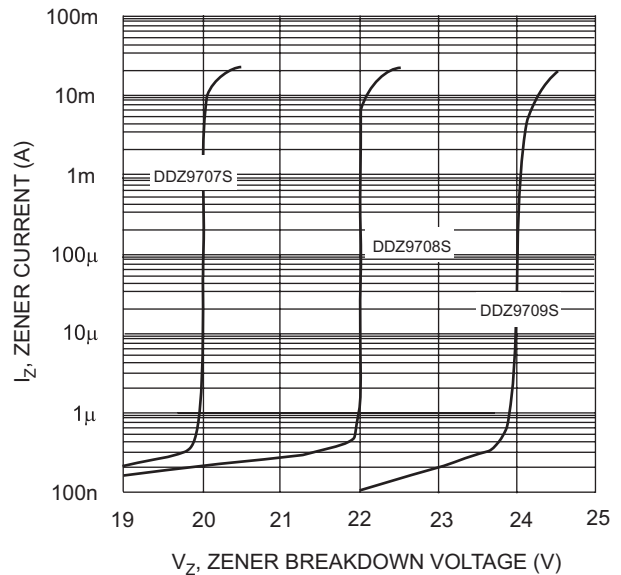

Fig. 7 Typical Reverse Characteristics, DDZ9707S - DDZ9709S

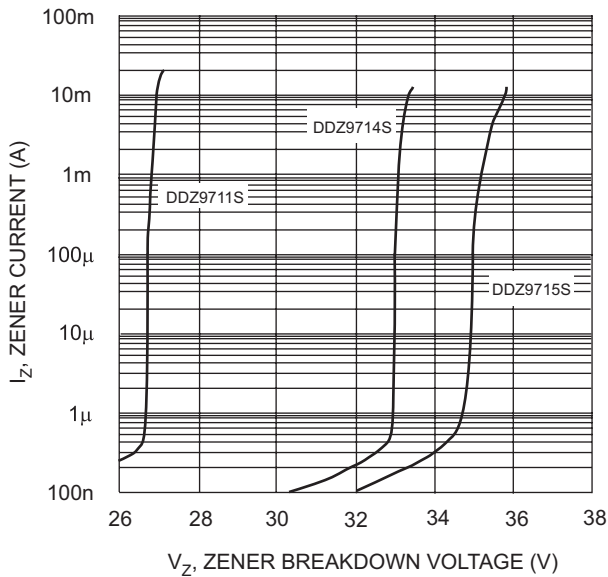

Fig. 8 Typical Reverse Characteristics, DDZ9711S - DDZ9715S

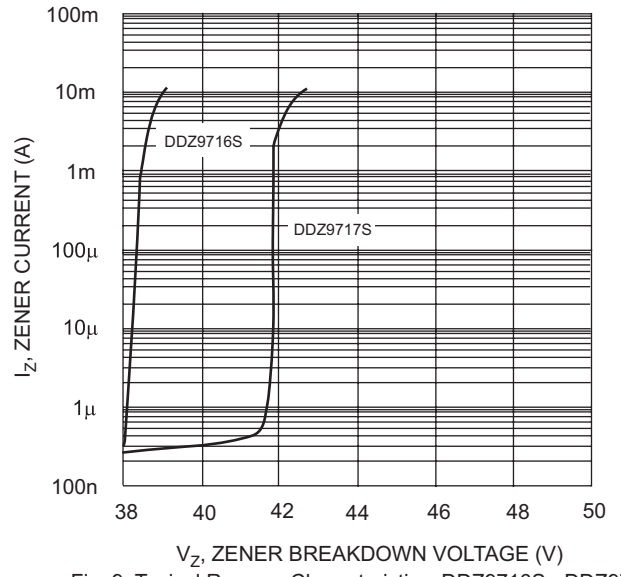

Fig. 9 Typical Reverse Characteristics, DDZ9716S - DDZ9717S

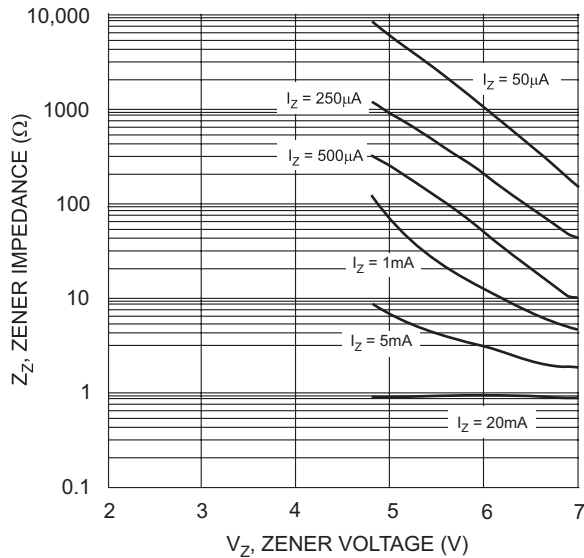

Fig. 10 Typical Zener Impedance Characteristics, DDZ9689S - DDZ9692S

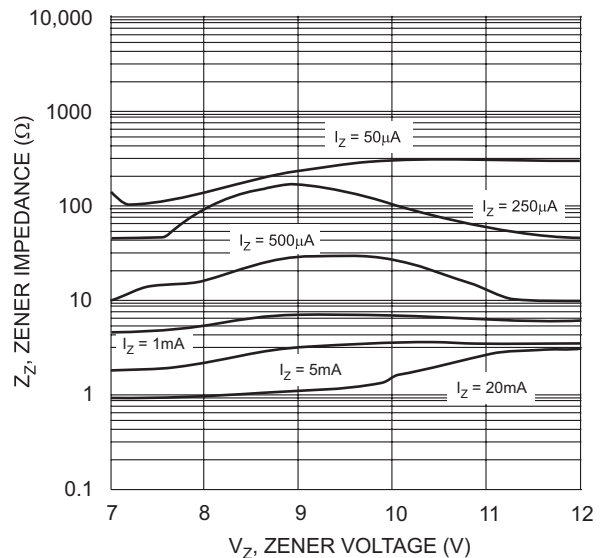

Fig. 11 Typical Zener Impedance Characteristics, DDZ9693S - DDZ9699S

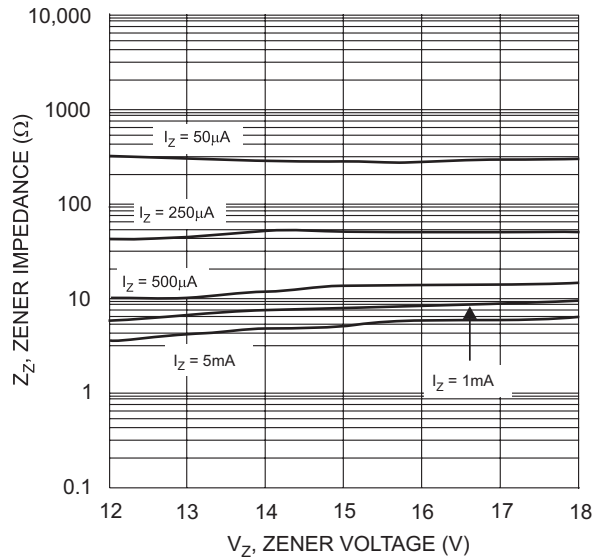

Fig. 12 Typical Zener Impedance Characteristics, DDZ9699S - DDZ9705S

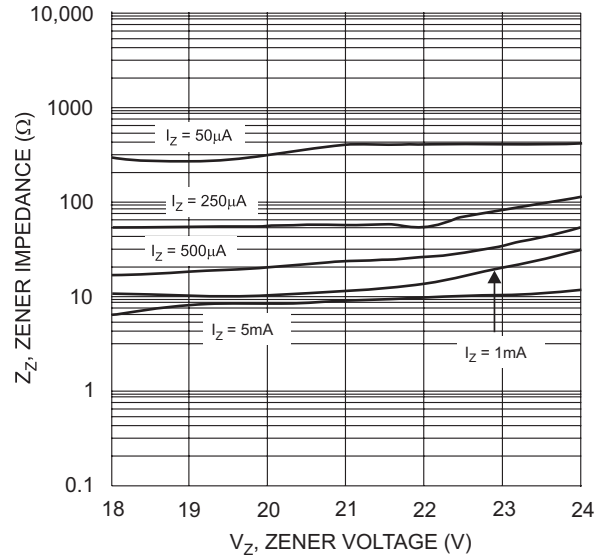

Fig. 13 Typical Zener Impedance Characteristics, DDZ9705S - DDZ9709S

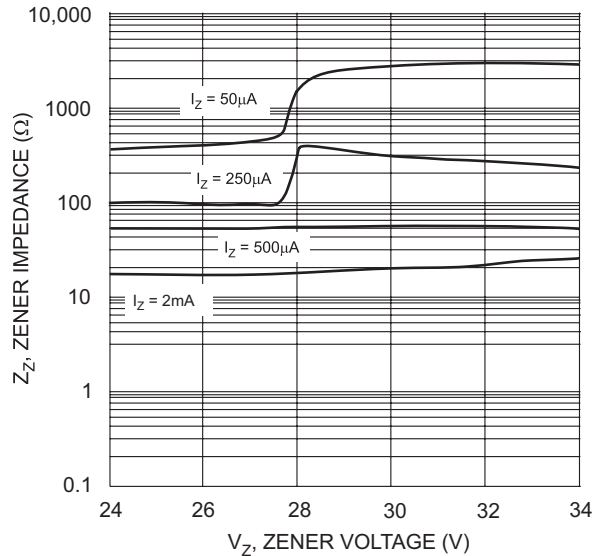

Fig. 14 Typical Zener Impedance Characteristics, DDZ9709S - DDZ9714S

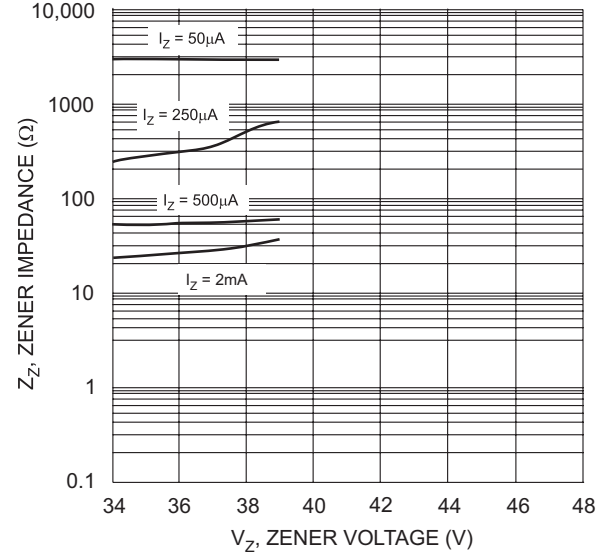

Fig. 15 Typical Zener Impedance Characteristics, DDZ9715S - DDZ9717S

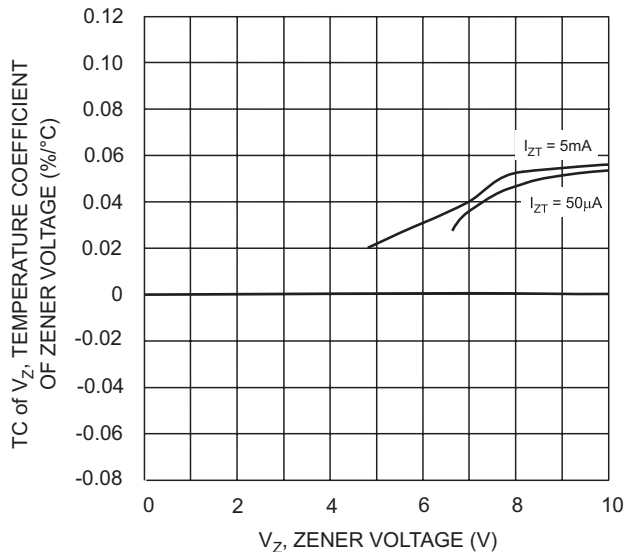

Fig. 16 Typical Temperature Coefficient of Zener Voltage vs. Zener Voltage, DDZ9692S - DDZ9697S

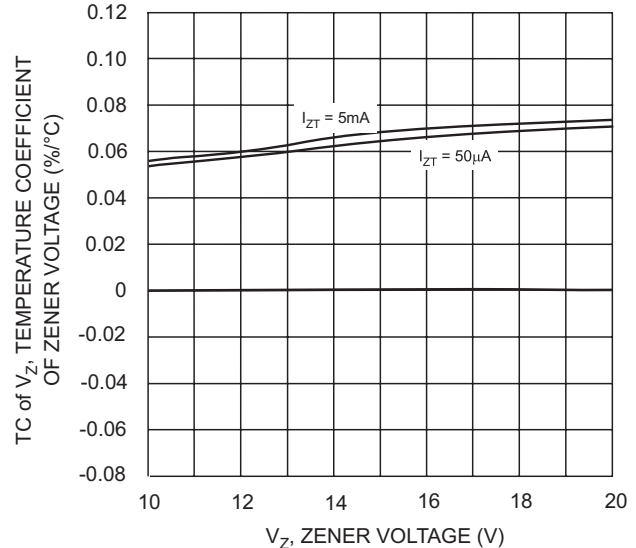

Fig. 17 Typical Temperature Coefficient of Zener Voltage vs. Zener Voltage, DDZ9697S - DDZ9707S

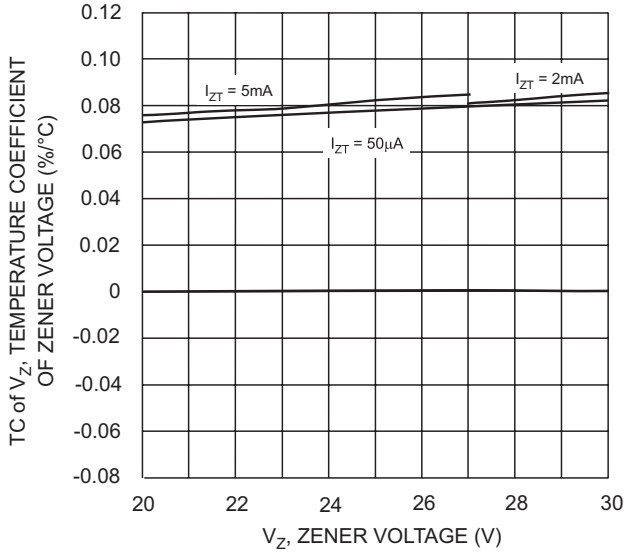

Fig. 18 Typical Temperature Coefficient of Zener Voltage, DDZ9707S - DDZ9713S

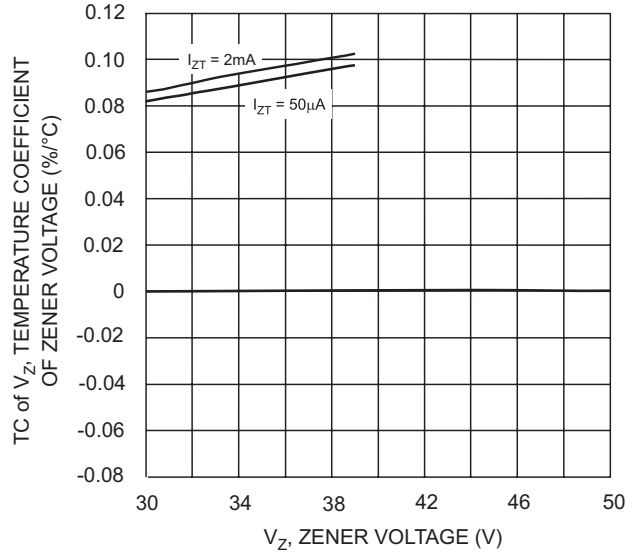

Fig. 19 Typical Temperature Coefficient of Zener Voltage, DDZ9713S - DDZ9717S

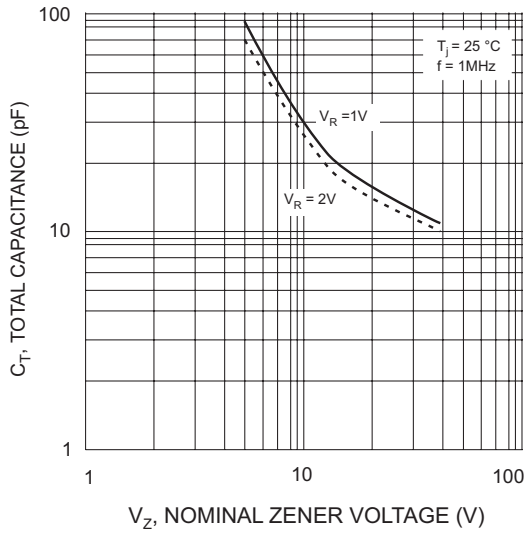

Fig. 20 Total Capacitance vs Nominal Zener Voltage

Ordering Information (Note 4)

| Device | Packaging | Shipping |
|------------------|-----------|------------------|
| (Type Number)-7* | SOD-323 | 3000/Tape & Reel |

* Example: The part number for the 6.2 Volt device would be DDZ9691S-7.

- Notes: 4. For Packaging Details, go to our website at <http://www.diodes.com/datasheets/ap02007.pdf>.
5. No purposefully added lead.

Marking Information



XX = Product Type Marking Code (See Table 1)

IMPORTANT NOTICE

Diodes Incorporated and its subsidiaries reserve the right to make modifications, enhancements, improvements, corrections or other changes without further notice to any product herein. Diodes Incorporated does not assume any liability arising out of the application or use of any product described herein; neither does it convey any license under its patent rights, nor the rights of others. The user of products in such applications shall assume all risks of such use and will agree to hold Diodes Incorporated and all the companies whose products are represented on our website, harmless against all damages.

LIFE SUPPORT

Diodes Incorporated products are not authorized for use as critical components in life support devices or systems without the expressed written approval of the President of Diodes Incorporated.