

# Low-Cost Fixed-Frequency EconOscillator™

DS1088L

## General Description

The DS1088L is a low-cost clock generator that produces a square-wave output without external timing components. The fixed-frequency oscillator is available in factory-calibrated frequencies from 312kHz to 133MHz. The DS1088L has a power-down pin for power-sensitive applications.

## Applications

- Printers
- Copiers
- Automotive Telematics
- Computer Peripherals
- POS Terminals
- Cable Modems

## Features

- ◆ Factory-Programmed, Square-Wave Generator from 312kHz to 133MHz
- ◆ Single Output
- ◆ No External Timing Components Required
- ◆ 2.7V to 3.6V Supply
- ◆ Power-Down Mode
- ◆ 1.0% Frequency Tolerance Over Temperature and Voltage
- ◆ Wide Temperature Range (-20°C to +85°C)

## Ordering Information

PART	FREQUENCY (MHz)	TEMP RANGE	PIN-PACKAGE
DS1088LU-02	2.048	-20°C to +85°C	8 μSOP
DS1088LU-10	10.0	-20°C to +85°C	8 μSOP
DS1088LU-16	16.6	-20°C to +85°C	8 μSOP
DS1088LU-66	66.6	-20°C to +85°C	8 μSOP
DS1088LU-100	100.0	-20°C to +85°C	8 μSOP
DS1088LU-yyy	*	-20°C to +85°C	8 μSOP

yyy = frequency

\*Email Custom\_EconOscillators\_Info@dalsemi.com for information/questions concerning custom frequencies.

## Typical Operating Circuit

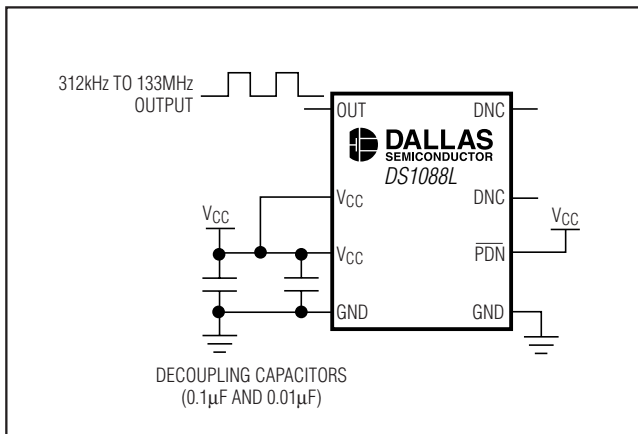

EconOscillator is a trademark of Dallas Semiconductor.

## Pin Configuration

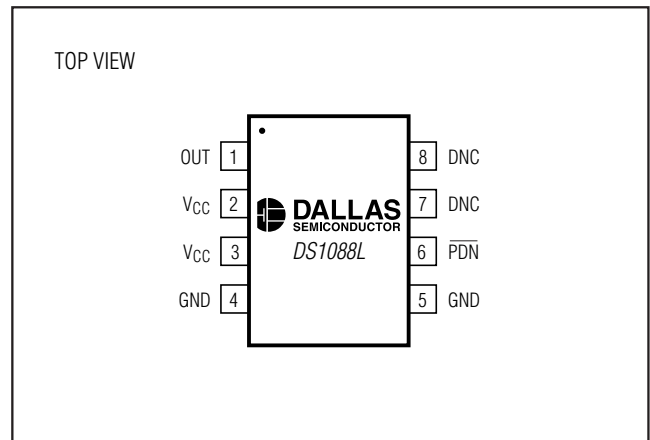

# Low-Cost Fixed-Frequency EconOscillator™

## ABSOLUTE MAXIMUM RATINGS

Voltage Range on  $V_{CC}$  Relative to Ground .....-0.5V to +6.0V  
 Voltage Range on  $\overline{PDN}$  Relative  
 to Ground\* .....-0.5V to ( $V_{CC} + 0.5V$ )

Operating Temperature Range .....-20°C to +85°C  
 Storage Temperature Range .....-55°C to +125°C  
 Soldering Temperature .....See IPC/JEDEC J-STD-020

\*Not to exceed +6.0V.

Stresses beyond those listed under "Absolute Maximum Ratings" may cause permanent damage to the device. These are stress ratings only, and functional operation of the device at these or any other conditions beyond those indicated in the operational sections of the specifications is not implied. Exposure to absolute maximum rating conditions for extended periods may affect device reliability.

## RECOMMENDED OPERATING CONDITIONS

( $T_A = -20^\circ\text{C}$  to  $+85^\circ\text{C}$ )

PARAMETER	SYMBOL	CONDITIONS	MIN	TYP	MAX	UNITS
Supply Voltage	$V_{CC}$	(Note 1)	2.7		3.6	V
High-Level Input Voltage ( $\overline{PDN}$ )	$V_{IH}$		$0.7 \times V_{CC}$		$V_{CC} + 0.3$	V
Low-Level Input Voltage ( $\overline{PDN}$ )	$V_{IL}$		-0.3		$0.3 \times V_{CC}$	V

## DC ELECTRICAL CHARACTERISTICS

( $V_{CC} = 2.7V$  to  $3.6V$ ,  $T_A = -20^\circ\text{C}$  to  $+85^\circ\text{C}$ .)

PARAMETER	SYMBOL	CONDITIONS	MIN	TYP	MAX	UNITS
High-Level Output Voltage (OUT)	$V_{OH}$	$I_{OH} = -4\text{mA}$ , $V_{CC} = \text{min}$	$V_{CC} - 0.4$			V
Low-Level Output Voltage (OUT)	$V_{OL}$	$I_{OL} = 4\text{mA}$			0.4	V
High-Level Input Current ( $\overline{PDN}$ )	$I_{IH}$	$V_{CC} = 3.6V$			1	$\mu\text{A}$
Low-Level Input Current ( $\overline{PDN}$ )	$I_{IL}$	$V_{IL} = 0$	-1			$\mu\text{A}$
Supply Current (Active)	$I_{CC}$	$V_{CC} = 3.6V$ , $C_L = 15\text{pF}$ , $f_0 = 133\text{MHz}$		15	24	mA
Standby Current (Power-Down)	$I_{CCQ}$	Power-down mode			10	$\mu\text{A}$

# Low-Cost Fixed-Frequency EconOscillator™

DS1088L

## OSCILLATOR CHARACTERISTICS

(V<sub>CC</sub> = 2.7V to 3.6V, T<sub>A</sub> = -20°C to +85°C.)

PARAMETER	SYMBOL	CONDITIONS	MIN	TYP	MAX	UNITS
Output Frequency Range Available	f <sub>0</sub>		0.3124		133.3	MHz
Output Frequency Tolerance	$\frac{\Delta f_0}{f_0}$	V <sub>CC</sub> = 3.3V, T <sub>A</sub> = +25°C (Note 8)	-0.3		+0.3	%
Voltage Frequency Variation	$\frac{\Delta f_V}{f_0}$	Over voltage range, T <sub>A</sub> = +25°C (Note 2)	-0.35		+0.35	%
Temperature Frequency Variation	$\frac{\Delta f_T}{f_0}$	Over temperature range, -20°C to +25°C	-0.7		+0.7	%
		V <sub>CC</sub> = 3.3V (Notes 3, 4) +25°C to +85°C	-0.5		+0.5	
Frequency Variation Over Voltage and Temperature	$\frac{\Delta f_{V,T}}{f_0}$	Over voltage and temperature range	-1.0		+1.0	%

## AC ELECTRICAL CHARACTERISTICS

(V<sub>CC</sub> = 2.7V to 3.6V, T<sub>A</sub> = -20°C to +85°C.)

PARAMETER	SYMBOL	CONDITIONS	MIN	TYP	MAX	UNITS
Power-Up Time	t <sub>POR</sub> + t <sub>STAB</sub>	(Note 5)			100	μs
OUT Disabled After Entering Power-Down Mode	t <sub>PDN</sub>	(Note 6)			7	μs
Load Capacitance	C <sub>L</sub>	(Note 7)		15	50	pF
Output Duty Cycle (OUT)		f <sub>0</sub> < 80MHz, f <sub>0</sub> ≥ 80MHz	40		60	%
		f <sub>0</sub> < 80MHz		50		

**Note 1:** All voltages are referenced to ground.

**Note 2:** This is the change in output frequency due to changes in voltage at T<sub>A</sub> = +25°C.

**Note 3:** This is the change in output frequency due to changes in temperature from the +25°C frequency at V<sub>CC</sub> = 3.3V.

**Note 4:** Guaranteed by design.

**Note 5:** This indicates the time elapsed between power-up and the output becoming active. An on-chip delay is intentionally introduced to allow the oscillator to stabilize. t<sub>STAB</sub> is equivalent to approximately 512 clock cycles and will depend on the programmed oscillator frequency.

**Note 6:** Output disabled in 2 cycles or less of the output frequency.

**Note 7:** Output voltage swings may be impaired at high frequencies combined with high-output loading.

**Note 8:** Typical frequency shift due to aging is within ±0.2%. Aging stressing includes level 1 moisture reflow preconditioning (24hr +125°C bake, 168hr +85°C/85%RH moisture soak, and three solder reflow passes +240°C +0°C/-5°C peak) followed by 1000hr (max) V<sub>CC</sub> biased +125°C OP/L, 1000hr unbiased +150°C bake, 1000 temperature cycles at -55°C to +125°C and 168hr +121°C/2 ATM steam/unbiased autoclave.

# Low-Cost Fixed-Frequency EconOscillator™

## Typical Operating Characteristics

( $V_{CC} = 3.3V$ ,  $T_A = +25^\circ C$ , unless otherwise noted.)

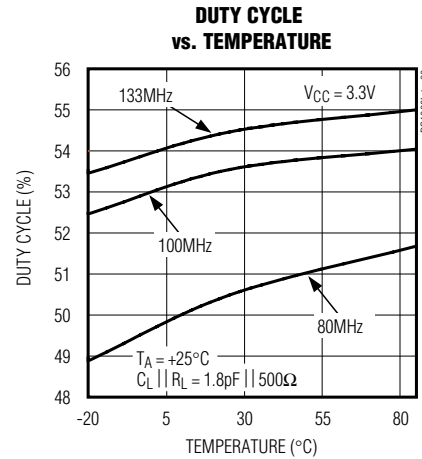
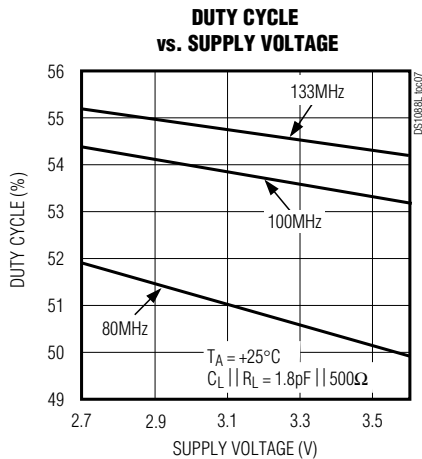
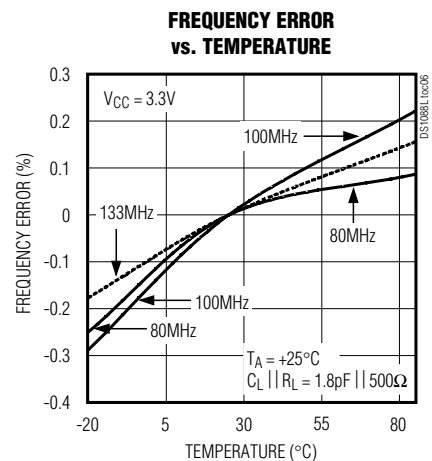
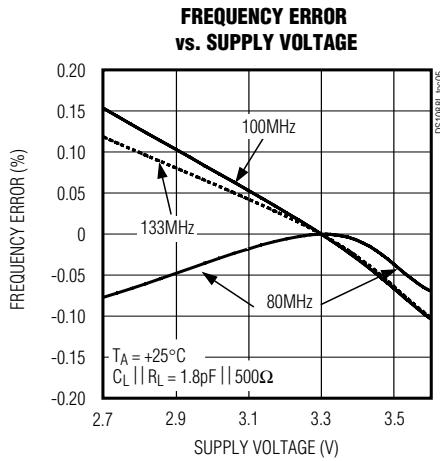
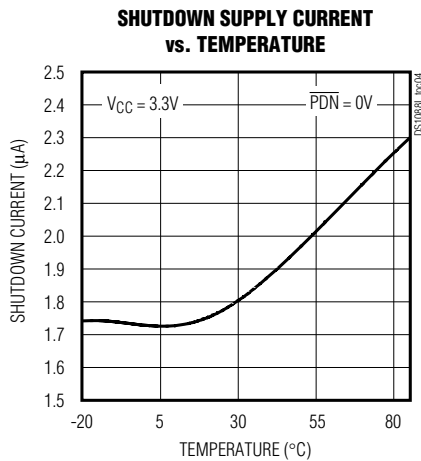
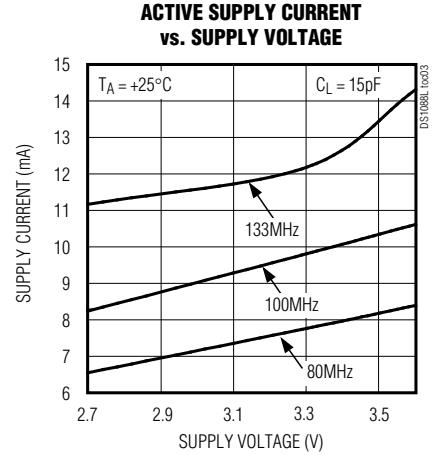
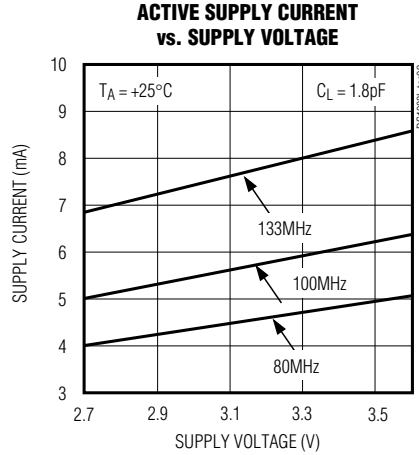
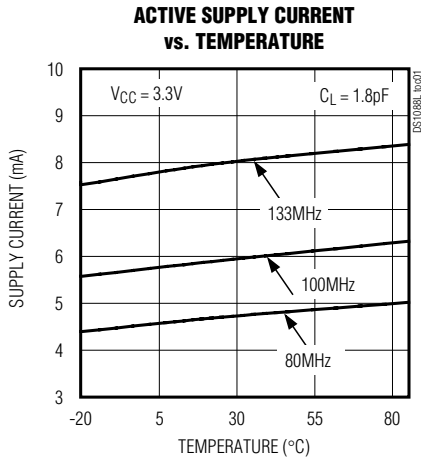

# Low-Cost Fixed-Frequency EconOscillator™

DS1088L

## Pin Description

PIN	NAME	FUNCTION
1	OUT	Oscillator Output
2	V <sub>CC</sub>	Power Supply
3	V <sub>CC</sub>	Power Supply
4	GND	Ground
5	GND	Ground
6	$\overline{\text{PDN}}$	Power-Down. When the pin is high, the oscillator is enabled. When the pin is low, the oscillator is disabled (power-down mode).
7	DNC	Do Not Connect. The DNC pins are internally connected to ground.
8	DNC	Do Not Connect

## Detailed Description

The DS1088L is a low-cost clock generator that produces a square-wave output without external timing components. The fixed-frequency oscillator is available in factory-calibrated frequencies from 312kHz to 133MHz. The DS1088L has a power-down pin for power-sensitive applications. A block diagram of the DS1088L is shown in Figure 1.

### Output Frequency

The internal oscillator frequency is divided by the factory-programmed prescaler to produce an output frequency of 312kHz to 133MHz. See the *Standard Frequency Options* table for a list of standard frequencies. Contact factory for custom frequencies.

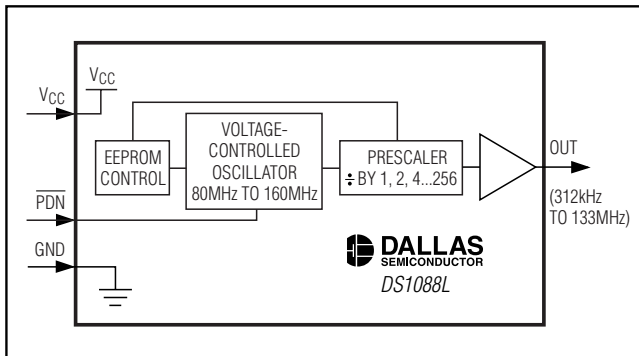

Figure 1. Block Diagram

## Power-Down Mode

The  $\overline{\text{PDN}}$  pin disables the internal oscillator and the oscillator output for power-sensitive applications. The power-down pin must remain low for at least two output frequency cycles plus 10 $\mu$ s for deglitching purposes. On power-up, the output is disabled until power is stable and the voltage-controlled oscillator has generated 512 clock cycles.

## Applications Information

### Power-Supply Decoupling

To achieve the best results when using the DS1088L, the power supply must be decoupled with 0.01 $\mu$ F and 0.1 $\mu$ F high-quality, ceramic, surface-mount capacitors. Surface-mount components minimize lead inductance, which improves performance, and tend to have adequate high-frequency response for decoupling applications. These capacitors should be placed as close to the V<sub>CC</sub> and GND pins as possible.

### Chip Topology

TRANSISTOR COUNT: 4507

SUBSTRATE CONNECTED TO GROUND.

### Package Information

For the latest package outline information, go to [www.maxim-ic.com/DallasPackInfo](http://www.maxim-ic.com/DallasPackInfo).

Maxim cannot assume responsibility for use of any circuitry other than circuitry entirely embodied in a Maxim product. No circuit patent licenses are implied. Maxim reserves the right to change the circuitry and specifications without notice at any time.

Maxim Integrated Products, 120 San Gabriel Drive, Sunnyvale, CA 94086 408-737-7600 \_\_\_\_\_ 5

© 2005 Maxim Integrated Products Printed USA **MAXIM** is a registered trademark of Maxim Integrated Products, Inc.

**DALLAS SEMICONDUCTOR** is a registered trademark of Dallas Semiconductor Corporation.