

Dual Bias Resistor Transistors

PNP Silicon Surface Mount Transistors with Monolithic Bias Resistor Network

The BRT (Bias Resistor Transistor) contains a single transistor with a monolithic bias network consisting of two resistors; a series base resistor and a base-emitter resistor. These digital transistors are designed to replace a single device and its external resistor bias network. The BRT eliminates these individual components by integrating them into a single device. In the DWA4XX series, two BRT devices are housed in the SOT-363 package which is ideal for low-power surface mount applications where board space is at a premium.

- . Simplifies Circuit Design
- . Reduces Board Space
- . Reduces Component Count
- . Available in 8 mm, 7 inch/3000 Unit Tape and Reel
- . We declare that the material of product compliance with RoHS requirements.

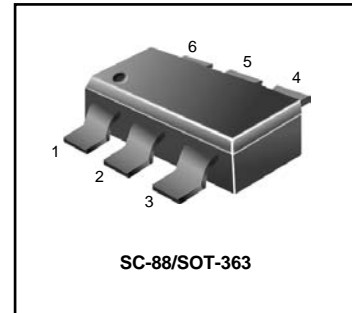

Ordering Information

Device	Package	Shipping
DWA4XX Series	SOT-363	3000/Tape&Reel

MAXIMUM RATINGS (T_A = 25°C unless otherwise noted, common for Q₁ and Q₂)

Rating	Symbol	Value	Unit
Collector-Base Voltage	V _{CBO}	-50	Vdc
Collector-Emitter Voltage	V _{CEO}	-50	Vdc
Collector Current	I _C	-100	mAdc

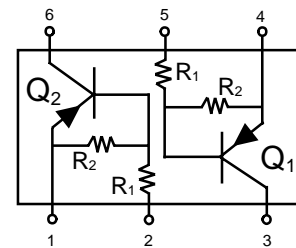

THERMAL CHARACTERISTICS

Characteristic (One Junction Heated)	Symbol	Max	Unit
Total Device Dissipation T _A = 25°C	P _D	187 (Note 1.) 256 (Note 2.)	mW
Derate above 25°C		1.5 (Note 1.) 2.0 (Note 2.)	mW/°C
Thermal Resistance – Junction-to-Ambient	R _{θJA}	670 (Note 1.) 490 (Note 2.)	°C/W
Characteristic (Both Junctions Heated)	Symbol	Max	Unit
Total Device Dissipation T _A = 25°C	P _D	250 (Note 1.) 385 (Note 2.)	mW
Derate above 25°C		2.0 (Note 1.) 3.0 (Note 2.)	mW/°C
Thermal Resistance – Junction-to-Ambient	R _{θJA}	493 (Note 1.) 325 (Note 2.)	°C/W
Thermal Resistance – Junction-to-Lead	R _{θJL}	188 (Note 1.) 208 (Note 2.)	°C/W
Junction and Storage Temperature	T _J , T _{stg}	-55 to +150	°C

1. FR-4 @ Minimum Pad 2. FR-4 @ 1.0 x 1.0 inch Pad

MARKING DIAGRAM

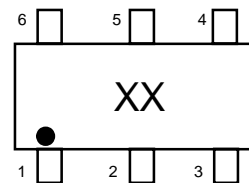

xx = Device Marking
(See Page 2)

DEVICE MARKING INFORMATION

See specific marking information in the device marking table on page 2 of this data sheet.



DWA401~412 , DWA417, 422, 423

DEVICE MARKING AND RESISTOR VALUES

Device	Package	Marking	R ₁ (K)	R ₂ (K)	Shipping
DWA402	SOT- 363	0A	10	10	3000/Tape & Reel
DWA403	SOT- 363	0B	22	22	3000/Tape & Reel
DWA404	SOT- 363	0C	47	47	3000/Tape & Reel
DWA407	SOT- 363	0D	10	47	3000/Tape & Reel
DWA411	SOT- 363	0E	10	—	3000/Tape & Reel
DWA410	SOT- 363	0F	4.7	—	3000/Tape & Reel
DWA423	SOT- 363	0G	1.0	1.0	3000/Tape & Reel
DWA417	SOT- 363	0H	2.2	2.2	3000/Tape & Reel
DWA401	SOT- 363	0J	4.7	4.7	3000/Tape & Reel
DWA406	SOT- 363	0K	4.7	47	3000/Tape & Reel
DWA408	SOT- 363	0L	22	47	3000/Tape & Reel
DWA405	SOT- 363	0M	2.2	47	3000/Tape & Reel
DWA422	SOT- 363	0N	100	100	3000/Tape & Reel
DWA409	SOT- 363	0P	47	22	3000/Tape & Reel

ELECTRICAL CHARACTERISTICS (T_A = 25°C unless otherwise noted, common for Q1 and Q2)

Characteristic	Symbol	Min	Typ	Max	Unit
----------------	--------	-----	-----	-----	------

OFF CHARACTERISTICS

Collector□Base Cutoff Current (V _{CB} = - 50 V, I _E = 0)	I _{CBO}	-	-	- 100	nAdc
Collector□Emitter Cutoff Current (V _{CE} = - 50 V, I _B = 0)	I _{CEO}	-	-	- 500	nAdc
Emitter – Base Cutoff Current (V _{EB} = - 6.0 V, I _C = 0)	I _{EBO}	-	-	- 0.5	mAdc
DWA402		-	-	- 0.2	
DWA403		-	-	- 0.1	
DWA404		-	-	- 0.2	
DWA407		-	-	- 0.9	
DWA411		-	-	- 1.9	
DWA410		-	-	- 4.3	
DWA423		-	-	- 2.3	
DWA417		-	-	- 1.5	
DWA401		-	-	- 0.18	
DWA406		-	-	- 0.13	
DWA408		-	-	- 0.2	
DWA405		-	-	- 0.05	
DWA422		-	-	- 0.13	
DWA409		-	-	-	
Collector□Base Breakdown Voltage (I _C = - 10uA, I _E = 0)	V _{(BR)CBO}	- 50	-	-	Vdc
Collector□Emitter Breakdown Voltage (Note 3) (I _C = - 2.0 mA, I _B = 0)	V _{(BR)CEO}	- 50	-	-	Vdc

3. New resistor combinations. Updated curves to follow in subsequent data sheets.
4. Pulse Test: Pulse Width < 300 μs, Duty Cycle < 2.0%



DWA401~412 , DWA417, 422, 423

ELECTRICAL CHARACTERISTICS (T_A = 25°C unless otherwise noted, common for Q₁ and Q₂),(Continued)

Characteristic		Symbol	Min	Typ	Max	Unit
ON CHARACTERISTICS (Note 4.)						
Collector-Emitter Saturation Voltage (I _C = -10 mA, I _B = -0.3 mA) (I _C = -10 mA, I _B = -5 mA) (I _C = -10 mA, I _B = -1 mA)	DWA402	V _{CE(sat)}	-	-	-0.25	Vdc
	DWA403		-	-	-0.25	
	DWA404		-	-	-0.25	
	DWA407		-	-	-0.25	
	DWA411		-	-	-0.25	
	DWA410		-	-	-0.25	
	DWA423		-	-	-0.25	
	DWA417		-	-	-0.25	
	DWA401		-	-	-0.25	
	DWA406		-	-	-0.25	
	DWA408		-	-	-0.25	
	DWA405		-	-	-0.25	
	DWA422		-	-	-0.25	
	DWA409		-	-	-0.25	
	DC Current Gain (V _{CE} = -10 V, I _C = -5.0mA)		DWA402	h _{FE}	35	
DWA403		60	100		-	
DWA404		80	140		-	
DWA407		80	140		-	
DWA411		160	250		-	
DWA410		160	250		-	
DWA423		3.0	5.0		-	
DWA417		8.0	15		-	
DWA401		15	27		-	
DWA406		80	140		-	
DWA408		80	130		-	
DWA405		80	140		-	
DWA422		80	130		-	
DWA409	80	140	-			
Output Voltage (on) (V _{CC} = -5.0 V, V _B = -2.5 V, R _L = 1.0kΩ) (V _{CC} = -5.0 V, V _B = -3.5 V, R _L = 1.0kΩ) (V _{CC} = -5.0 V, V _B = -5.5 V, R _L = 1.0kΩ) (V _{CC} = -5.0 V, V _B = -4.0 V, R _L = 1.0kΩ)	DWA402	V _{OL}	-	-	-0.2	Vdc
	DWA403		-	-	-0.2	
	DWA404		-	-	-0.2	
	DWA407		-	-	-0.2	
	DWA411		-	-	-0.2	
	DWA410		-	-	-0.2	
	DWA423		-	-	-0.2	
	DWA417		-	-	-0.2	
	DWA401		-	-	-0.2	
	DWA406		-	-	-0.2	
	DWA408		-	-	-0.2	
	DWA405		-	-	-0.2	
	DWA422		-	-	-0.2	
	DWA409		-	-	-0.2	
	Output Voltage (off) (V _{CC} = -5.0 V, V _B = -0.5 V, R _L = 1.0kΩ) (V _{CC} = -5.0 V, V _B = -0.05 V, R _L = 1.0kΩ) (V _{CC} = -5.0 V, V _B = -0.25 V, R _L = 1.0kΩ)		DWA402	V _{OH}	-4.9	
DWA403		-4.9	-		-	
DWA404		-4.9	-		-	
DWA407		-4.9	-		-	
DWA411		-4.9	-		-	
DWA410		-4.9	-		-	
DWA423		-4.9	-		-	
DWA417		-4.9	-		-	
DWA401		-4.9	-		-	
DWA406		-4.9	-		-	
DWA408		-4.9	-		-	
DWA405		-4.9	-		-	
DWA422		-4.9	-		-	
DWA409		-4.9	-		-	

4. Pulse Test: Pulse Width < 300us, Duty Cycle < 2.0%



DWA401~412 , DWA417, 422, 423

ELECTRICAL CHARACTERISTICS

(T_A = 25°C unless otherwise noted, common for Q₁ and Q₂.) (Continued)

Characteristic		Symbol	Min	Typ	Max	Unit
ON CHARACTERISTICS (Note 5.)						
Input Resistor	DWA402	R ₁	7.0	10	13	k Ω
	DWA403		15.4	22	28.6	
	DWA404		32.9	47	61.1	
	DWA407		7.0	10	13	
	DWA411		7.0	10	13	
	DWA410		3.3	4.7	6.1	
	DWA423		0.7	1.0	1.3	
	DWA417		1.5	2.2	2.9	
	DWA401		3.3	4.7	6.1	
	DWA406		3.3	4.7	6.1	
	DWA408		15.4	22	28.6	
	DWA405		1.54	2.2	2.86	
	DWA422		70	100	130	
	DWA409		32.9	47	61.1	
Resistor Ratio	DWA402	R ₁ /R ₂	0.8	1.0	1.2	
	DWA403		0.8	1.0	1.2	
	DWA404		0.8	1.0	1.2	
	DWA407		0.17	0.21	0.25	
	DWA411		-	-	-	
	DWA410		-	-	-	
	DWA423		0.8	1.0	1.2	
	DWA417		0.8	1.0	1.2	
	DWA401		0.8	1.0	1.2	
	DWA406		0.055	0.12	0.185	
	DWA408		0.38	0.47	0.56	
	DWA405		0.038	0.047	0.056	
	DWA422		0.8	1.0	1.2	
	DWA409		1.7	2.15	2.6	

5. Pulse Test: Pulse Width < 300 ms, Duty Cycle < 2.0%

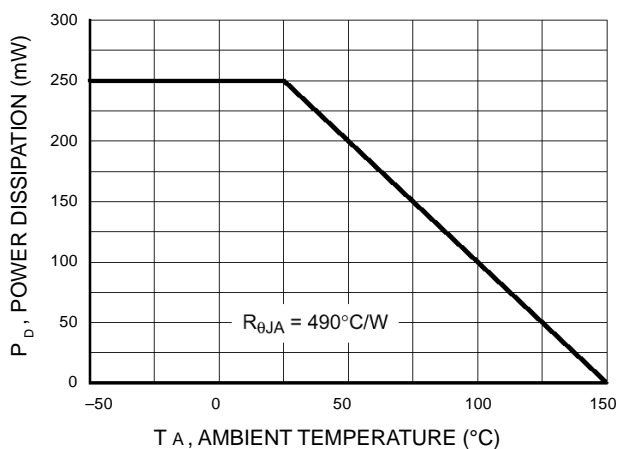

Figure 1. Derating Curve



TYPICAL ELECTRICAL CHARACTERISTICS – DWA402

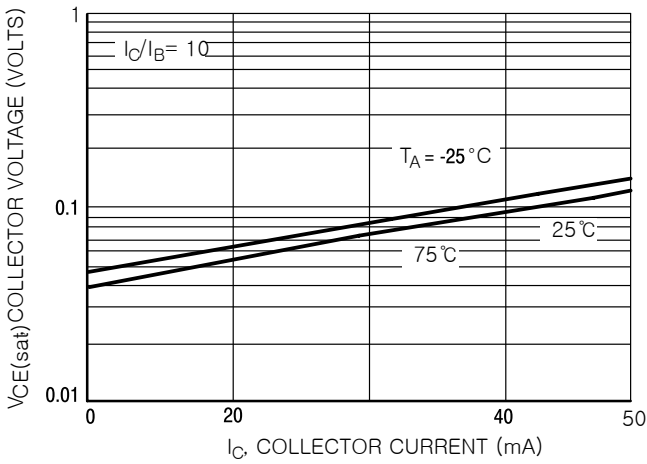

Figure 2. $V_{CE(sat)}$ versus I_C

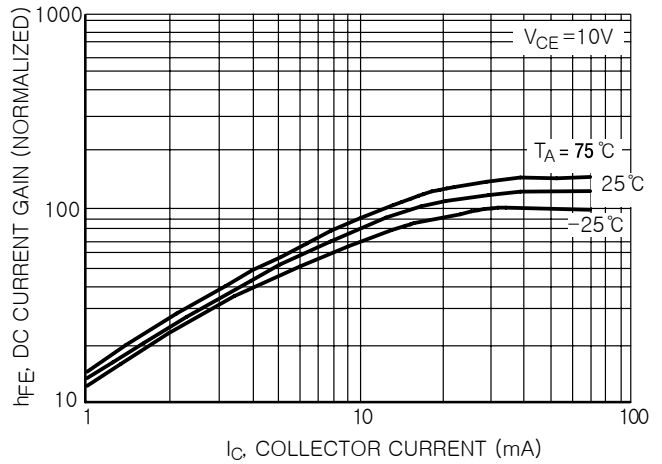

Figure 3. DC Current Gain

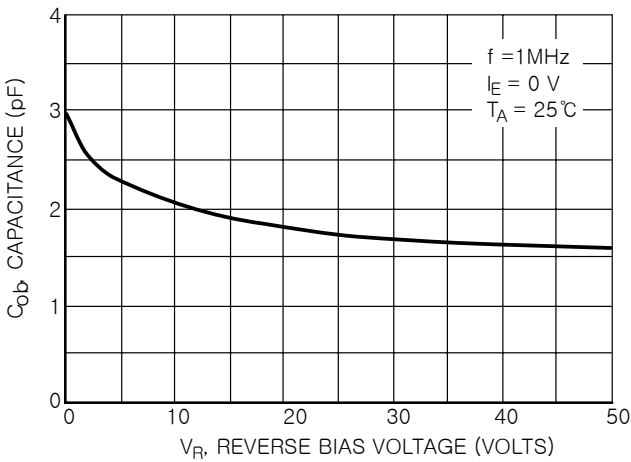

Figure 4. Output Capacitance

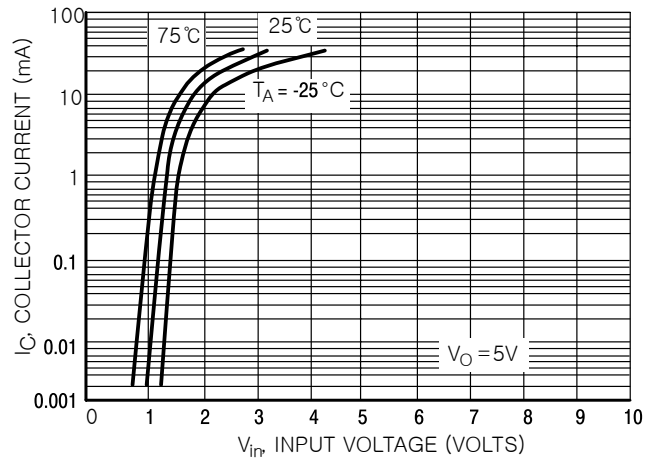

Figure 5. Output Current versus Input Voltage

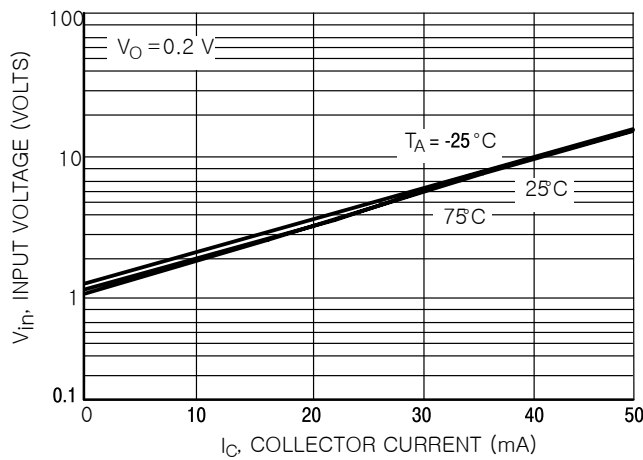

Figure 6. Input Voltage versus Output Current

TYPICAL ELECTRICAL CHARACTERISTICS – DWA403

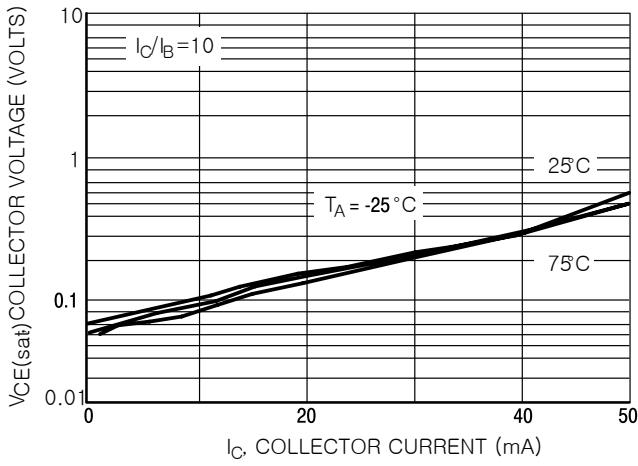

Figure 7. $V_{CE(sat)}$ versus I_C

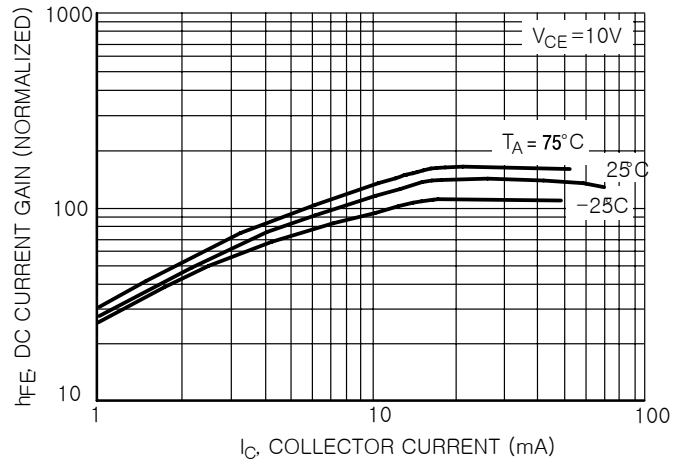

Figure 8. DC Current Gain

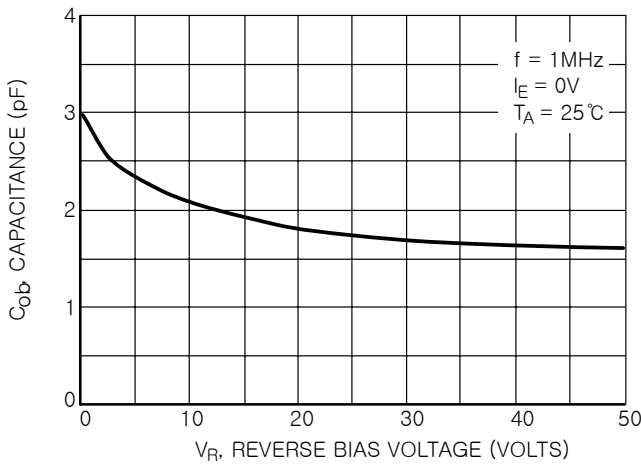

Figure 9. Output Capacitance

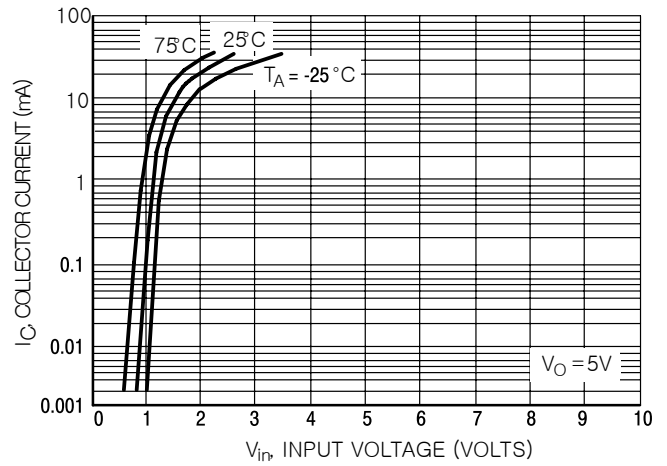

Figure 10. Output Current versus Input Voltage

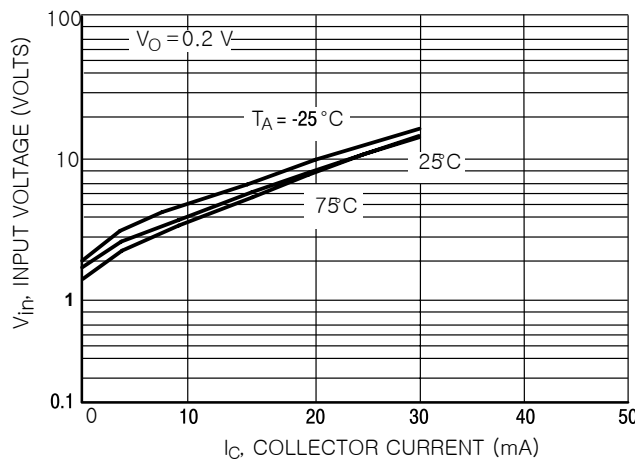

Figure 11. Input Voltage versus Output Current

TYPICAL ELECTRICAL CHARACTERISTICS – DWA404

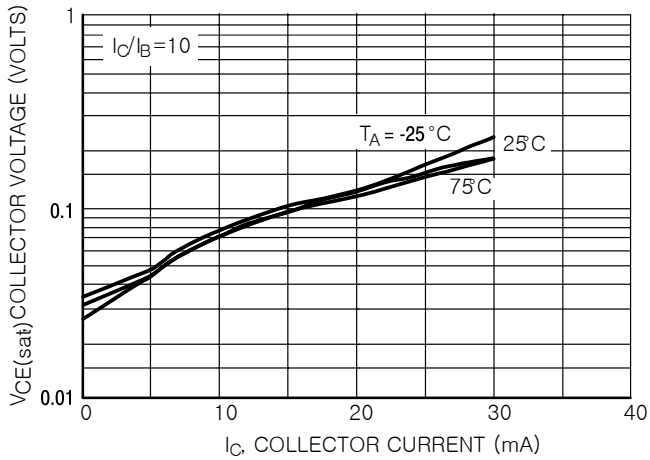

Figure 12. $V_{CE(sat)}$ versus I_C

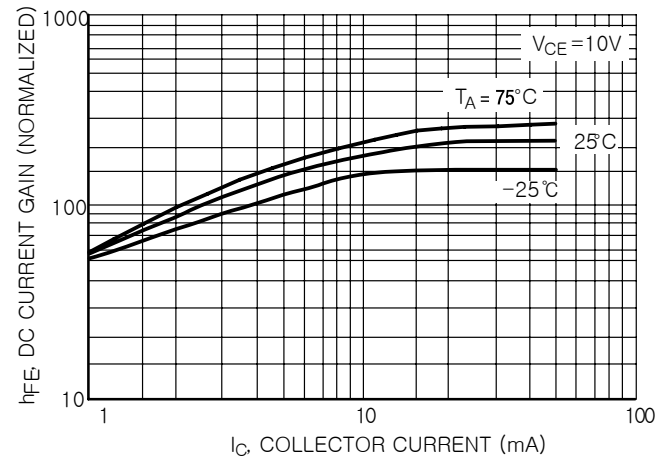

Figure 13. DC Current Gain

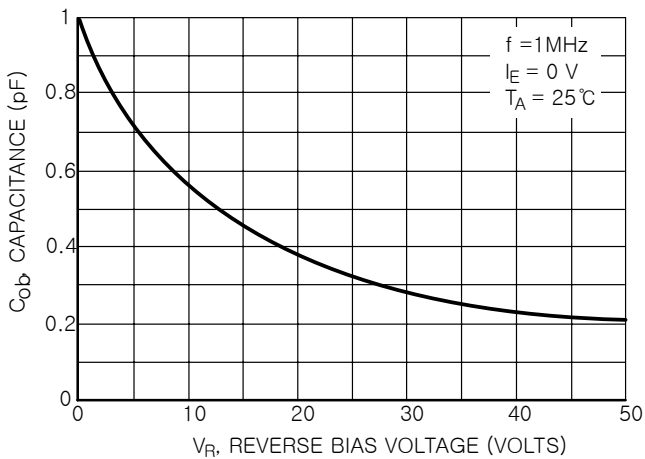

Figure 14. Output Capacitance

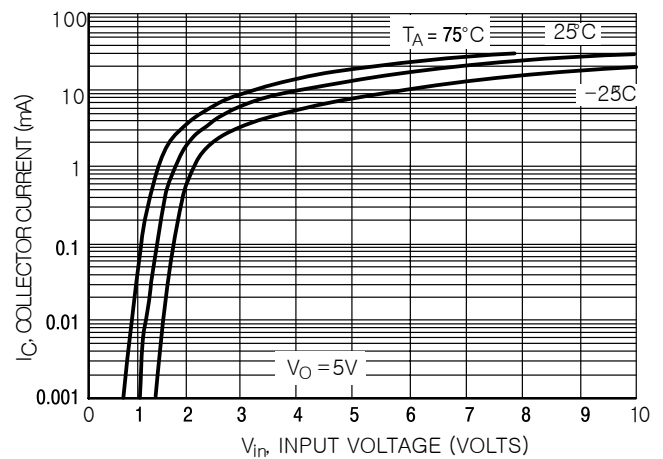

Figure 15. Output Current versus Input Voltage

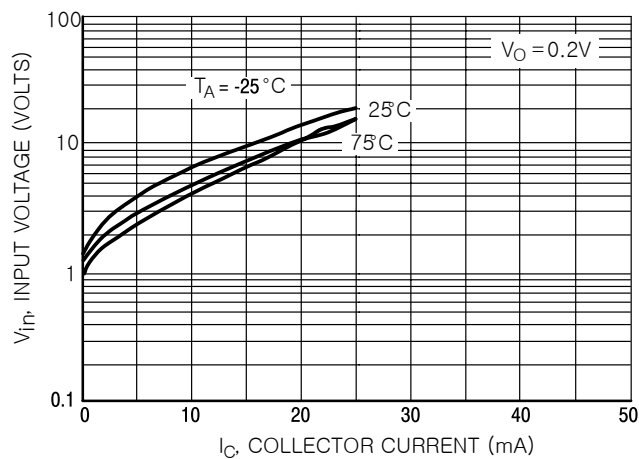

Figure 16. Input Voltage versus Output Current

TYPICAL ELECTRICAL CHARACTERISTICS – DWA407

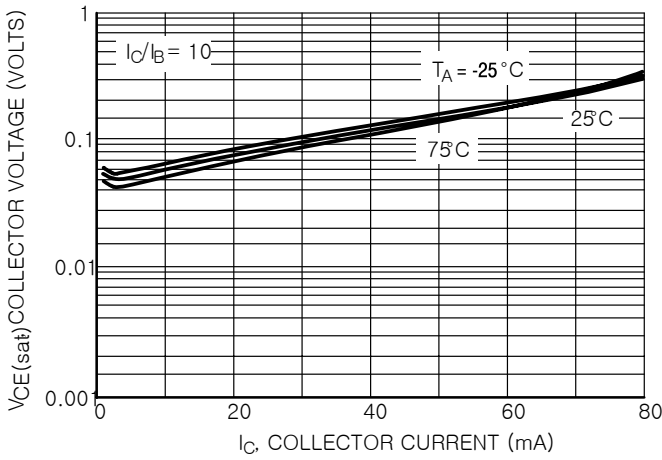

Figure 17. $V_{CE(sat)}$ versus I_C

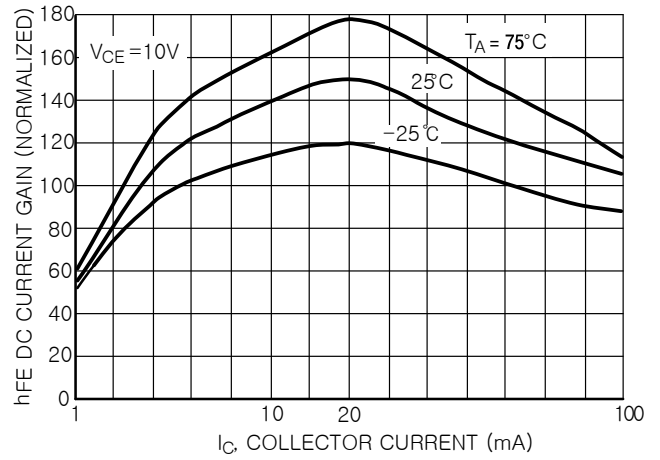

Figure 18. DC Current Gain

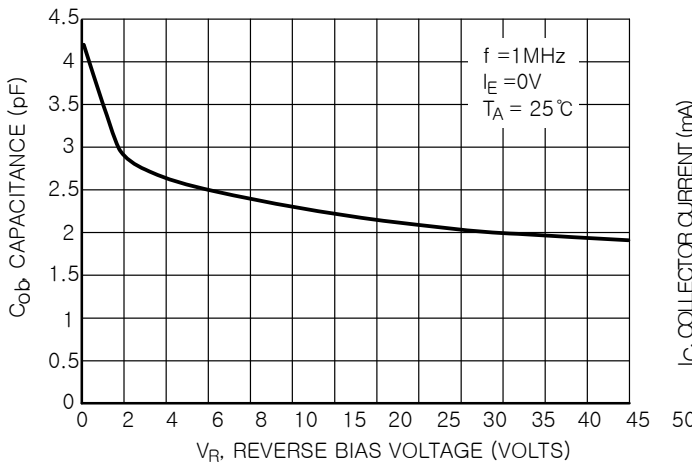

Figure 19. Output Capacitance

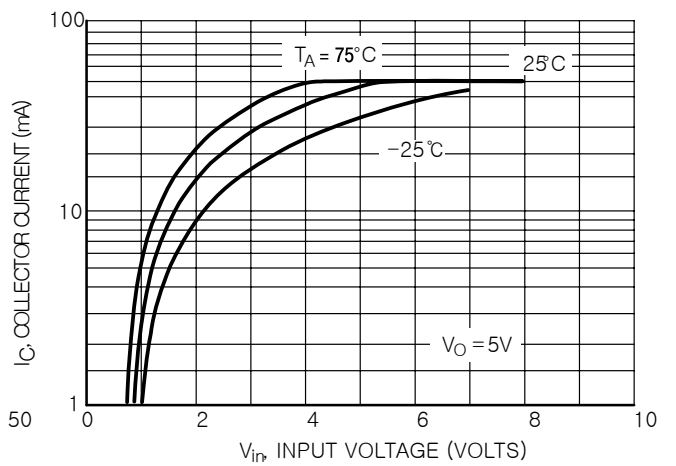

Figure 20. Output Current versus Input Voltage

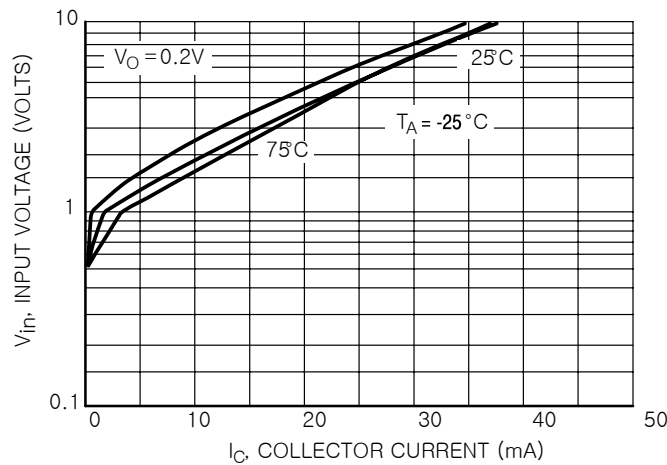

Figure 21. Input Voltage versus Output Current

TYPICAL ELECTRICAL CHARACTERISTICS – DWA411

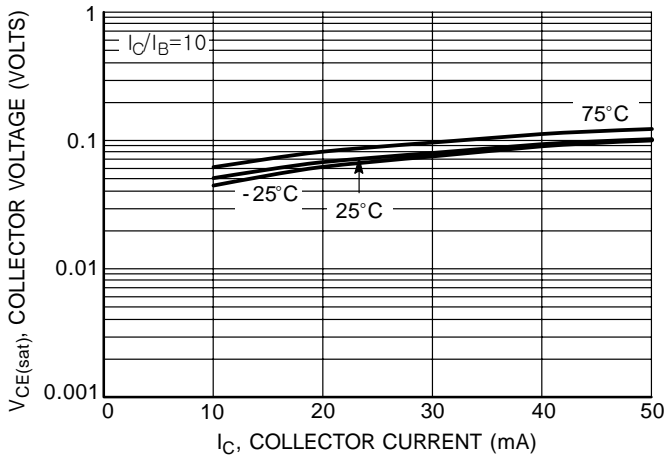

Figure 22. $V_{CE(sat)}$ versus I_C

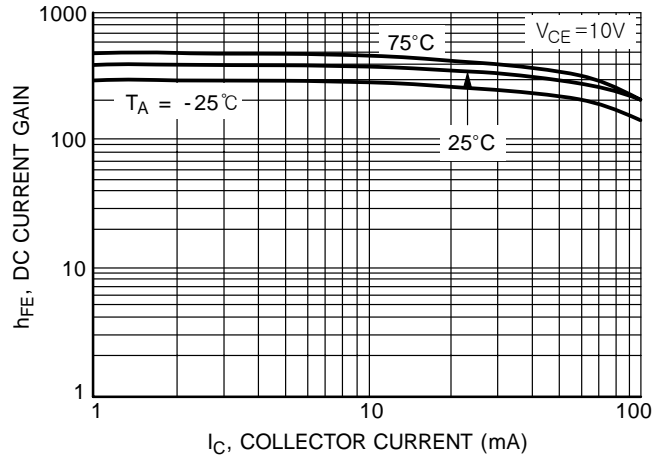

Figure 23. DC Current Gain

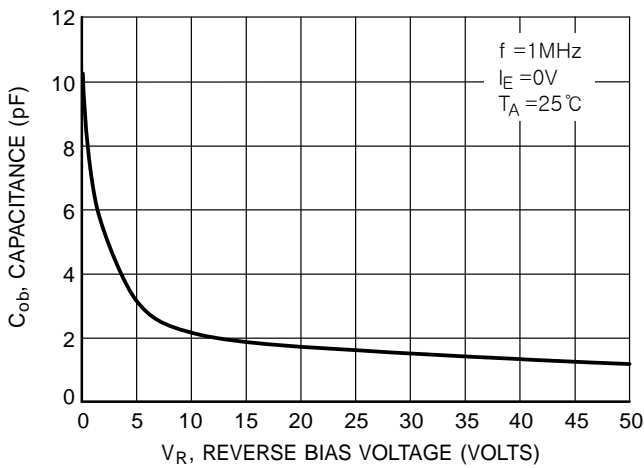

Figure 24. Output Capacitance

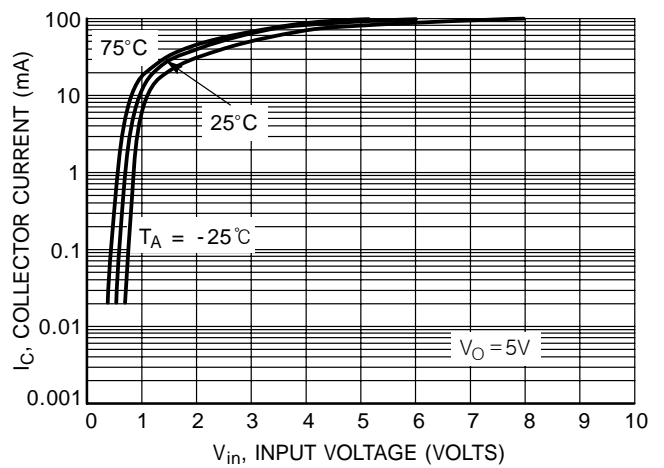

Figure 25. Output Current versus Input Voltage

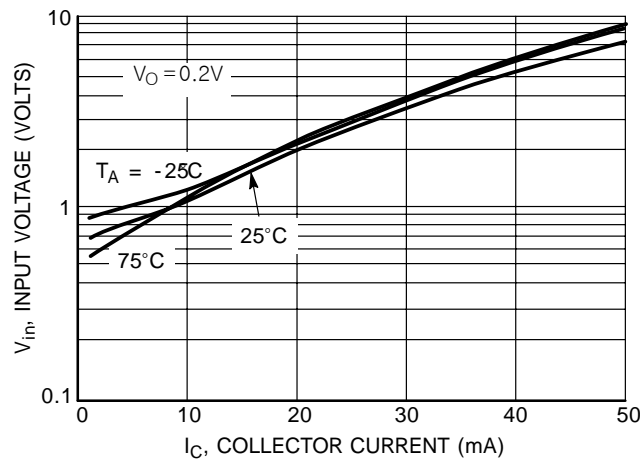

Figure 26. Input Voltage versus Output Current

TYPICAL ELECTRICAL CHARACTERISTICS – DWA410

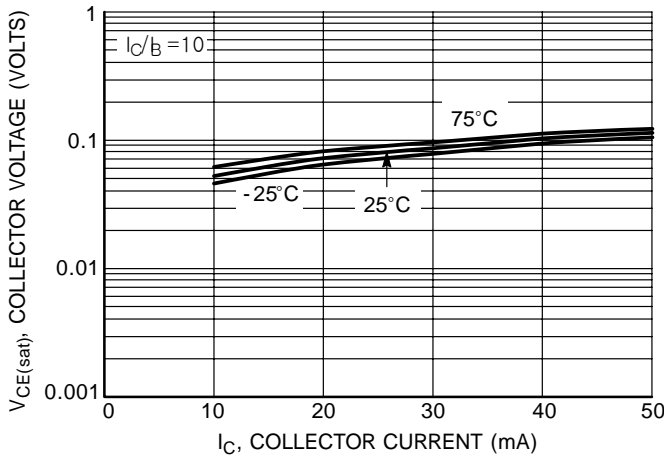

Figure 27. $V_{CE(sat)}$ versus I_C

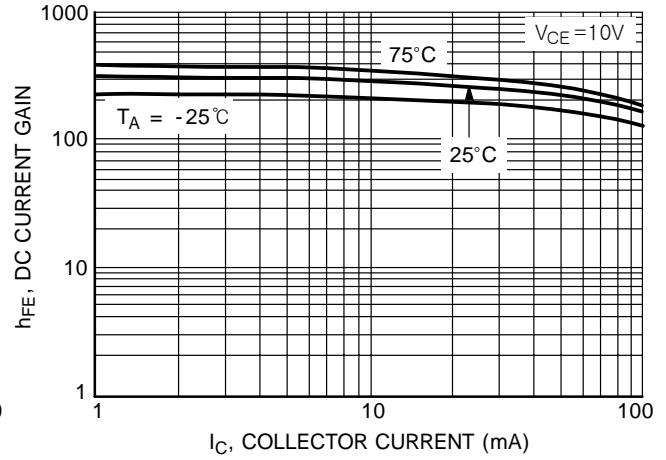

Figure 28. DC Current Gain

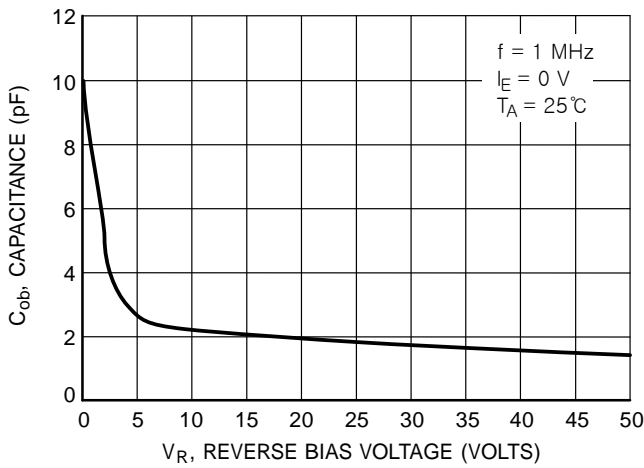

Figure 29. Output Capacitance

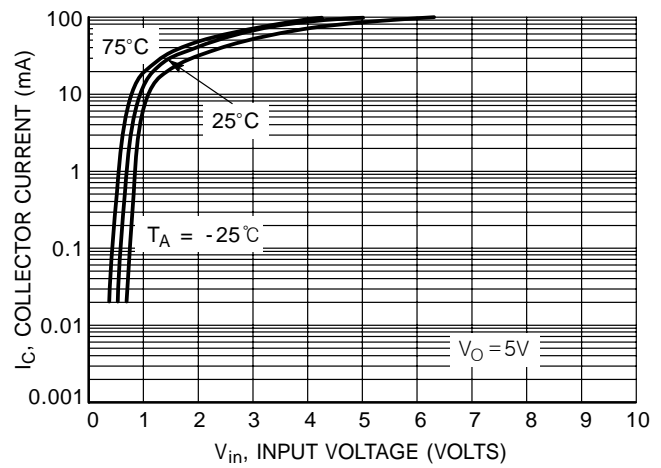

Figure 30. Output Current versus Input Voltage

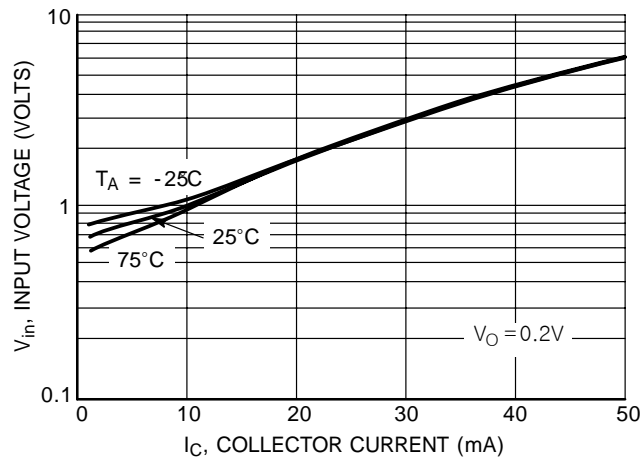

Figure 31. Input Voltage versus Output Current

TYPICAL ELECTRICAL CHARACTERISTICS – DWA423

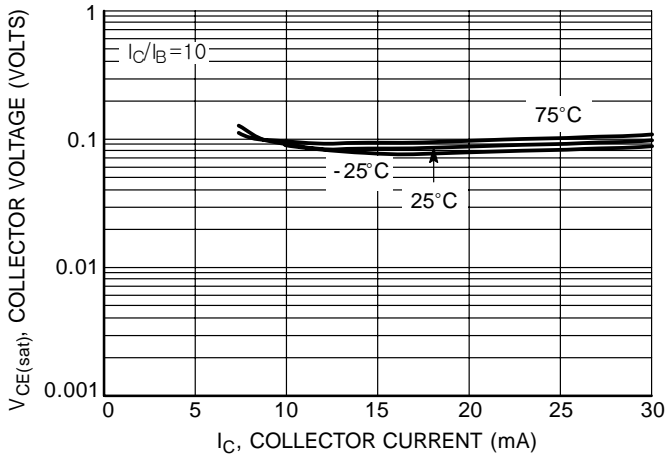

Figure 32. $V_{CE(sat)}$ versus I_C

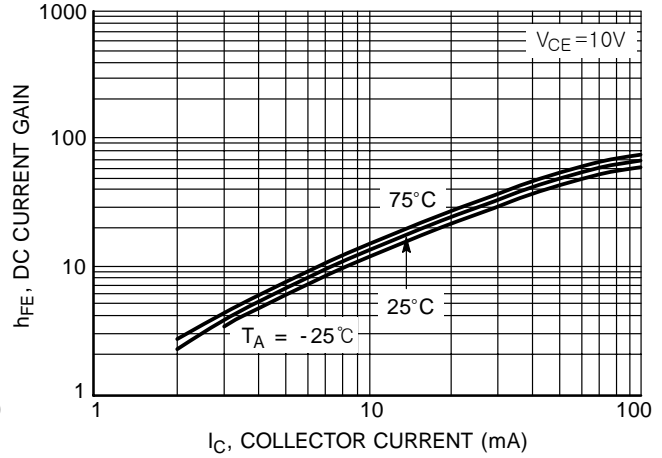

Figure 33. DC Current Gain

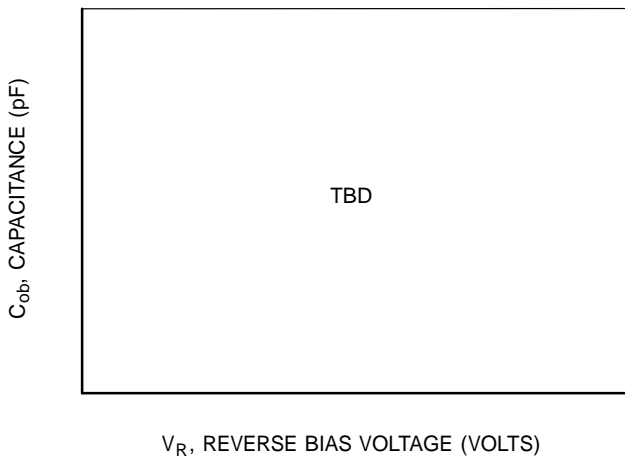

Figure 34. Output Capacitance

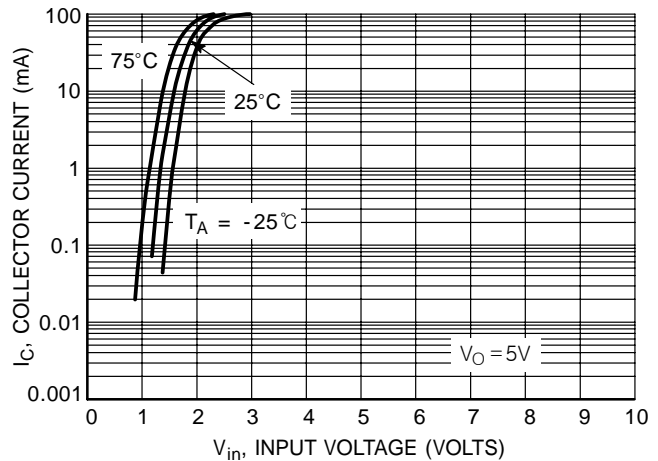

Figure 35. Output Current versus Input Voltage

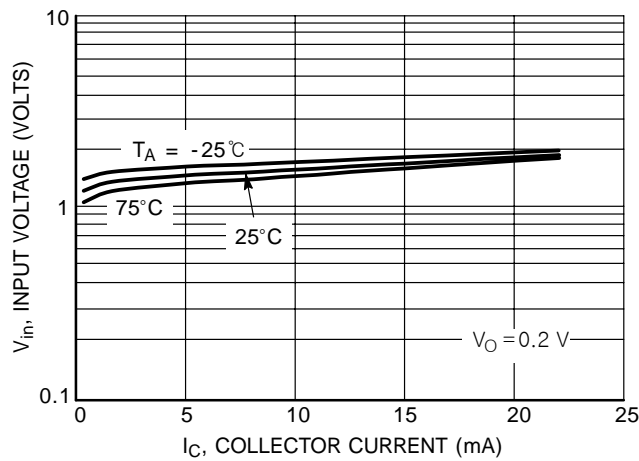

Figure 36. Input Voltage versus Output Current

TYPICAL ELECTRICAL CHARACTERISTICS – DWA417

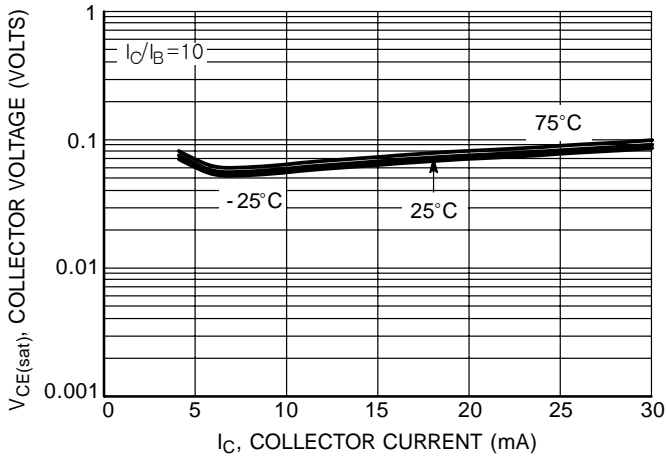

Figure 37. $V_{CE(sat)}$ versus I_C

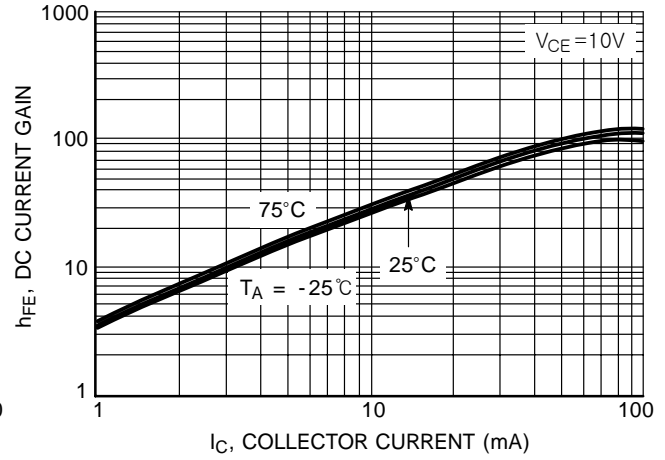

Figure 38. DC Current Gain

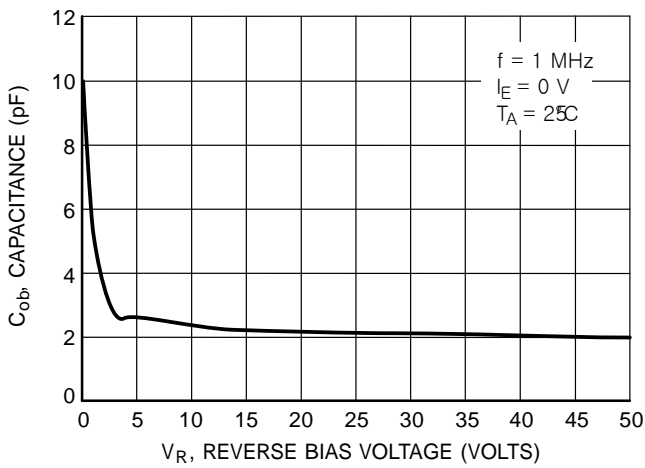

Figure 39. Output Capacitance

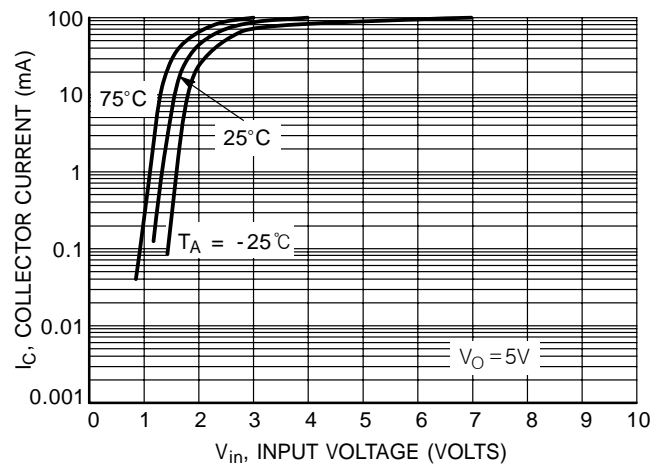

Figure 40. Output Current versus Input Voltage

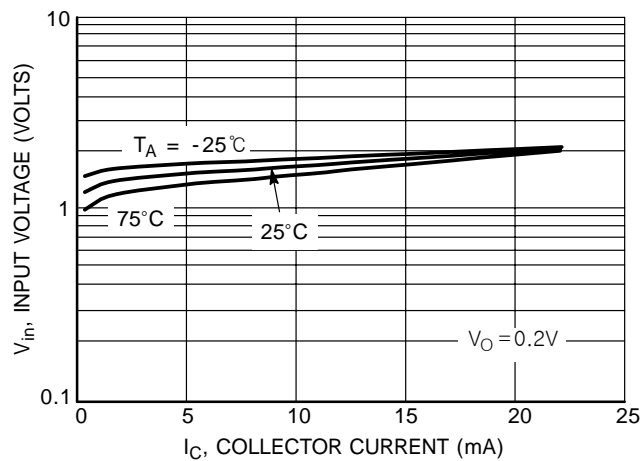

Figure 41. Input Voltage versus Output Current

TYPICAL ELECTRICAL CHARACTERISTICS – DWA401

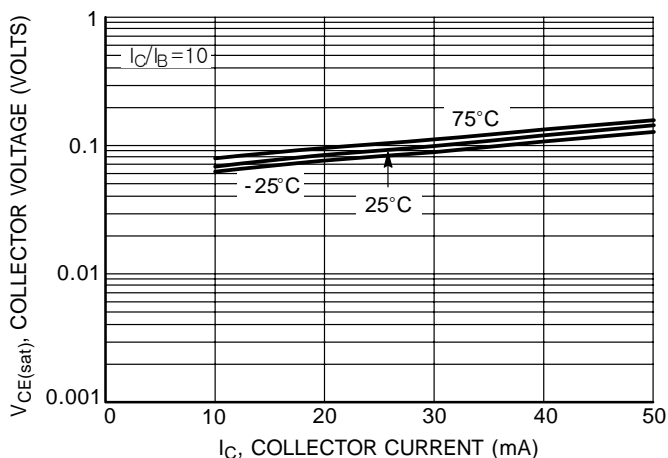

Figure 42. $V_{CE(sat)}$ versus I_C

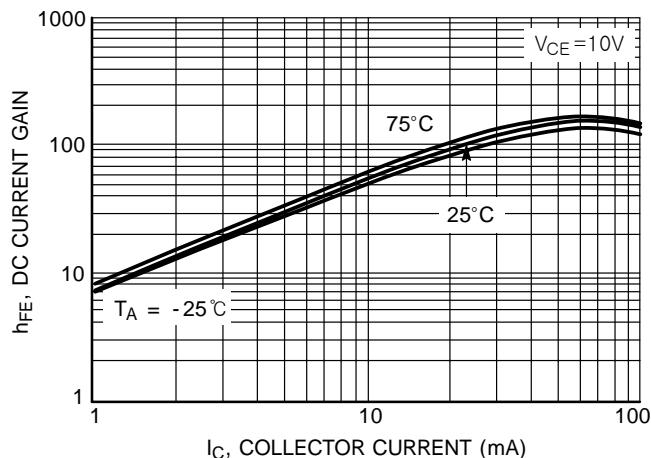

Figure 43. DC Current Gain

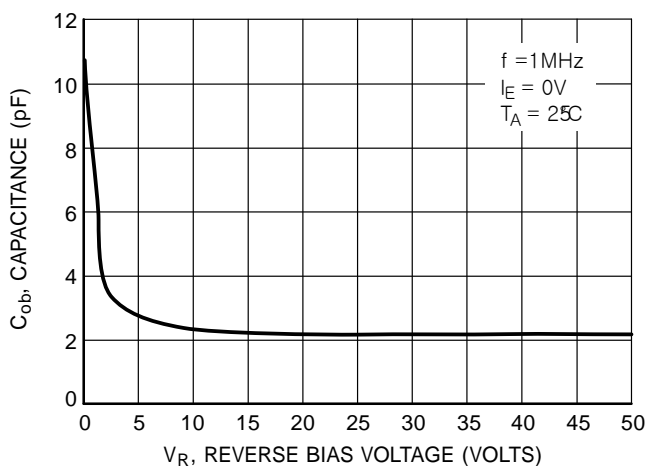

Figure 44. Output Capacitance

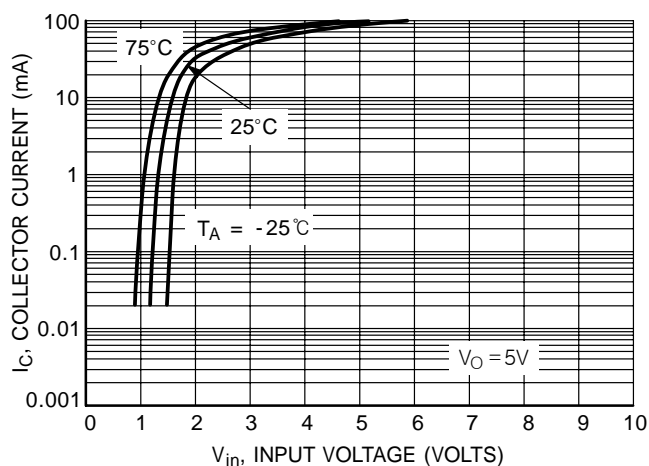

Figure 45. Output Current versus Input Voltage

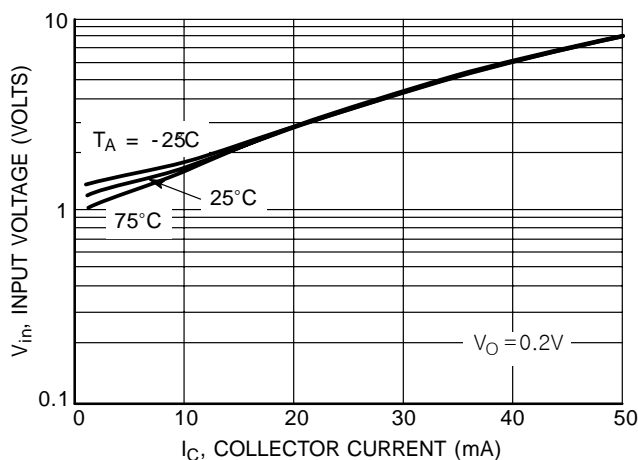

Figure 46. Input Voltage versus Output Current



TYPICAL ELECTRICAL CHARACTERISTICS – DWA406

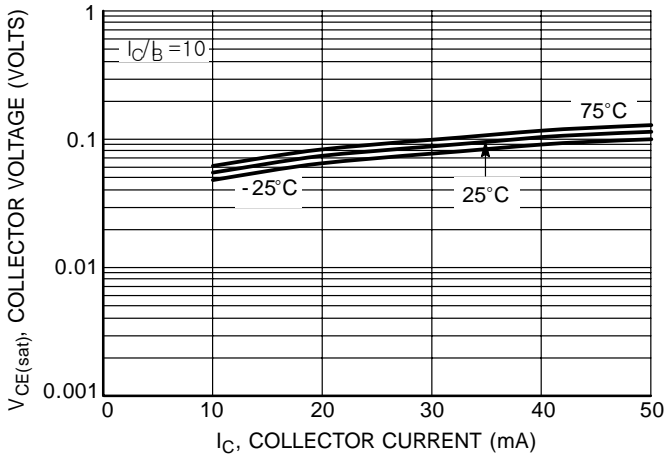

Figure 47. $V_{CE(sat)}$ versus I_C

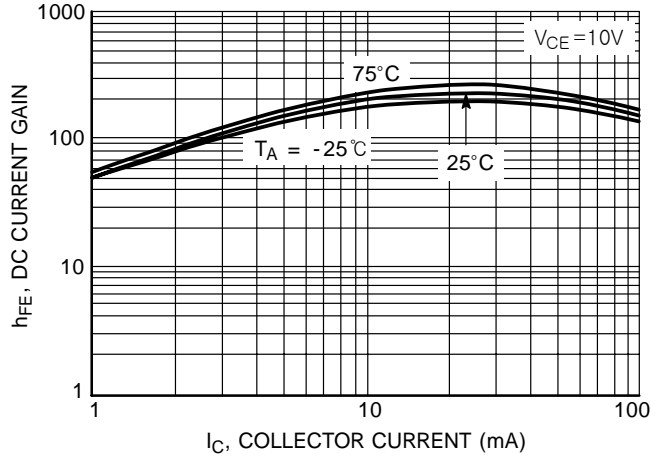

Figure 48. DC Current Gain

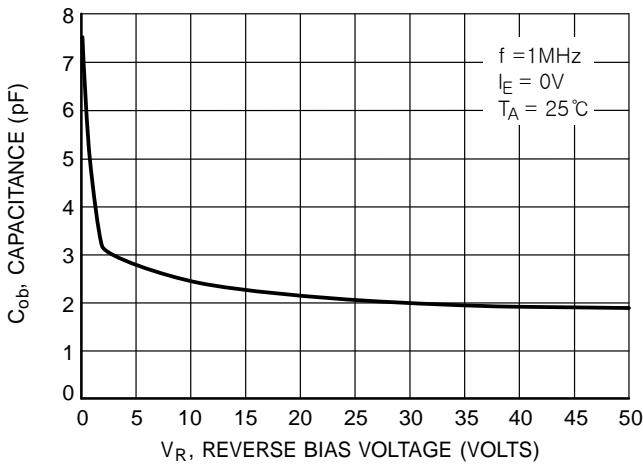

Figure 49. Output Capacitance

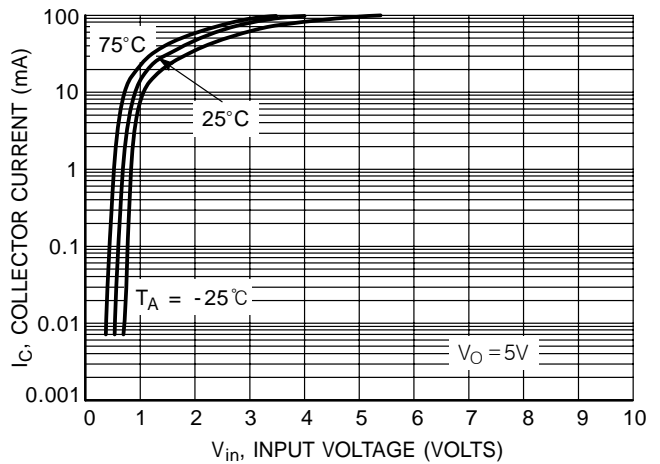

Figure 50. Output Current versus Input Voltage

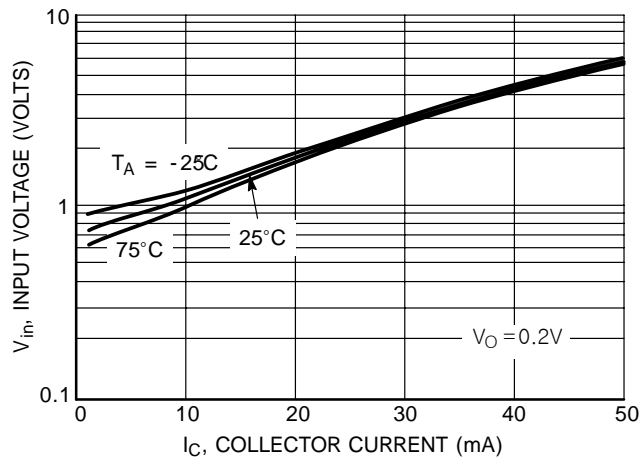

Figure 51. Input Voltage versus Output Current

TYPICAL ELECTRICAL CHARACTERISTICS – DWA408

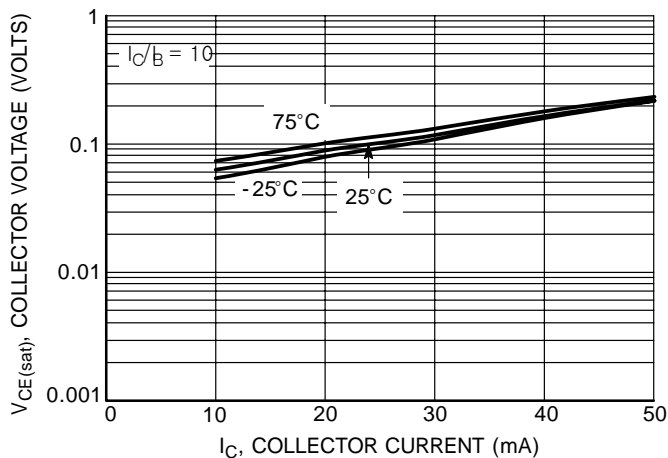

Figure 52. $V_{CE(sat)}$ versus I_C

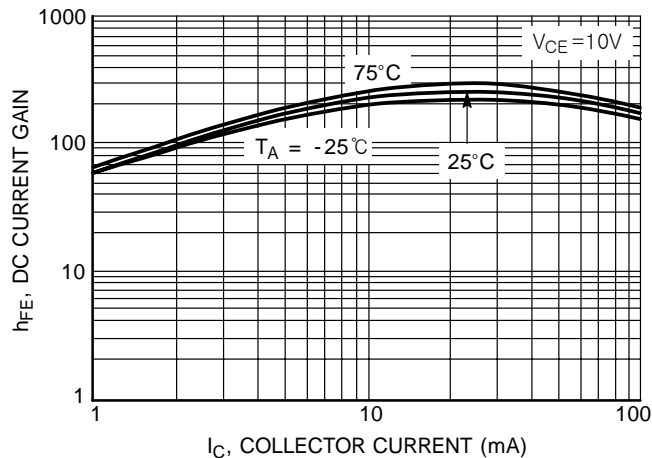

Figure 53. DC Current Gain

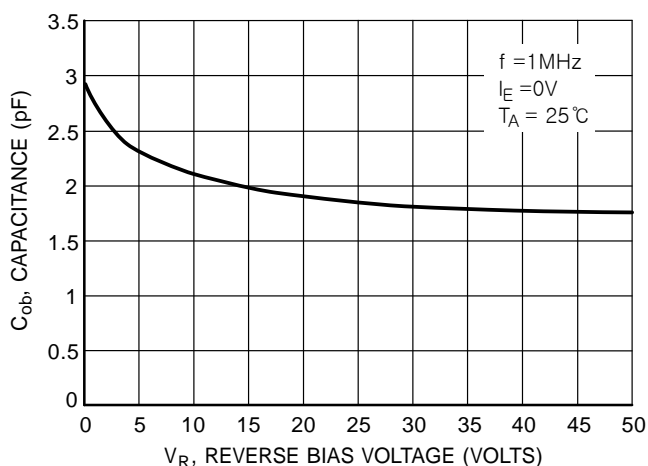

Figure 54. Output Capacitance

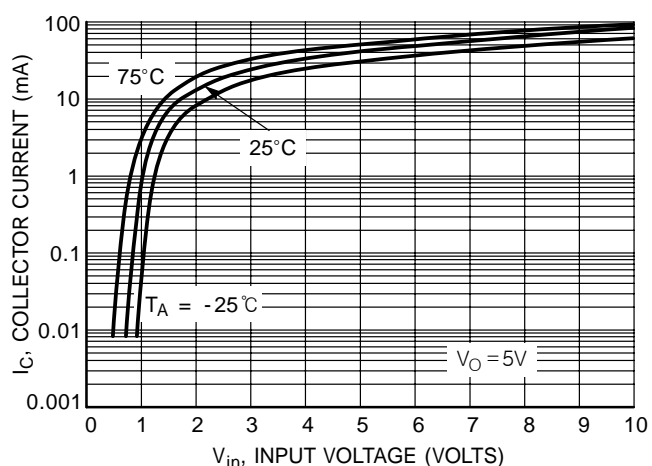

Figure 55. Output Current versus Input Voltage

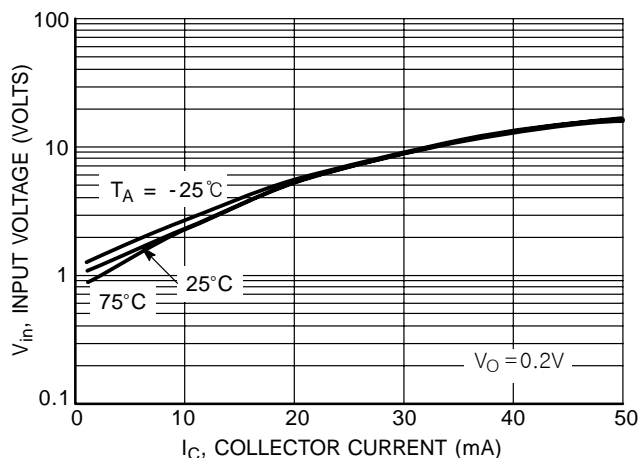

Figure 56. Input Voltage versus Output Current

TYPICAL ELECTRICAL CHARACTERISTICS – DWA405

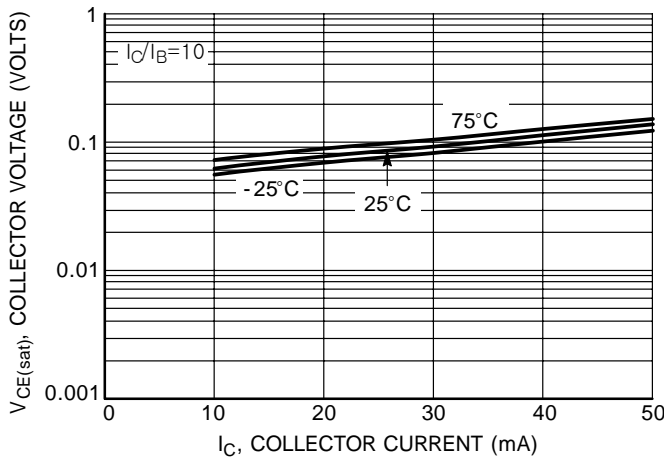

Figure 57. $V_{CE(sat)}$ versus I_C

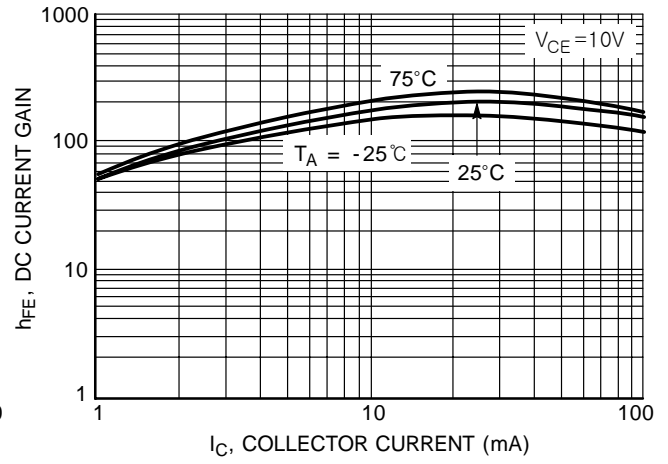

Figure 58. DC Current Gain

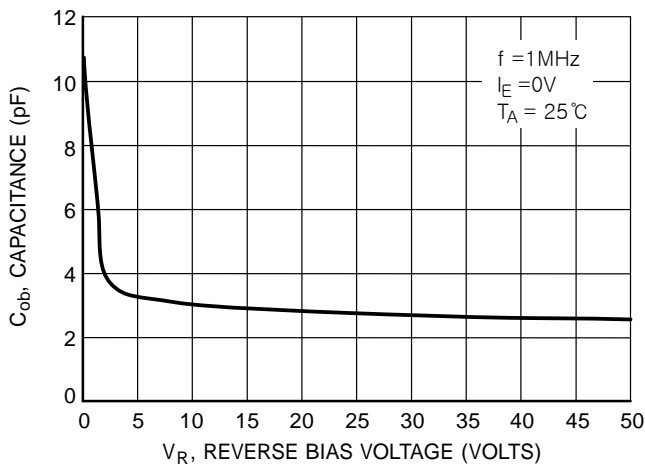

Figure 59. Output Capacitance

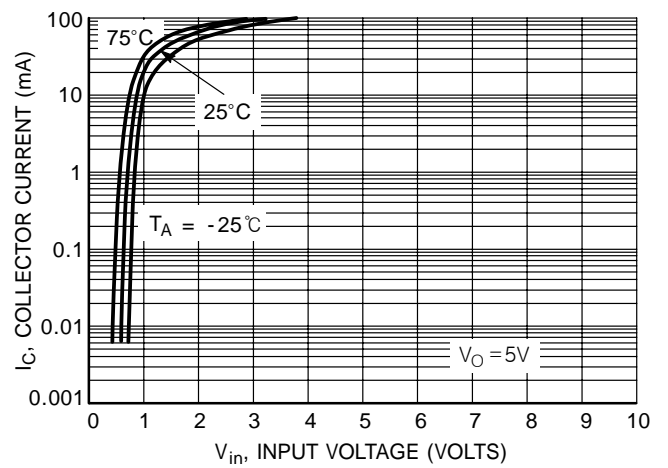

Figure 60. Output Current versus Input Voltage

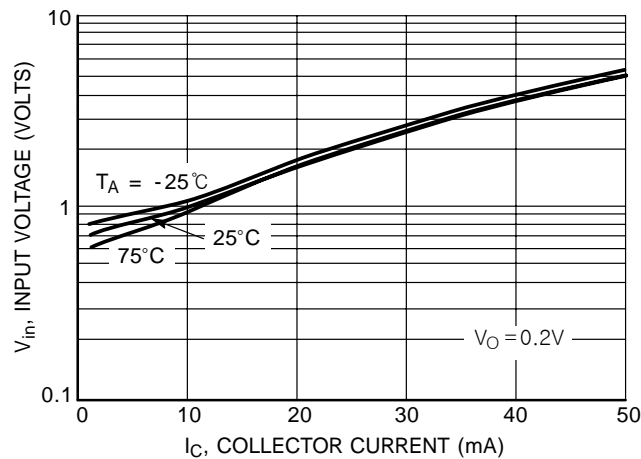

Figure 61. Input Voltage versus Output Current

TYPICAL ELECTRICAL CHARACTERISTICS – DWA422

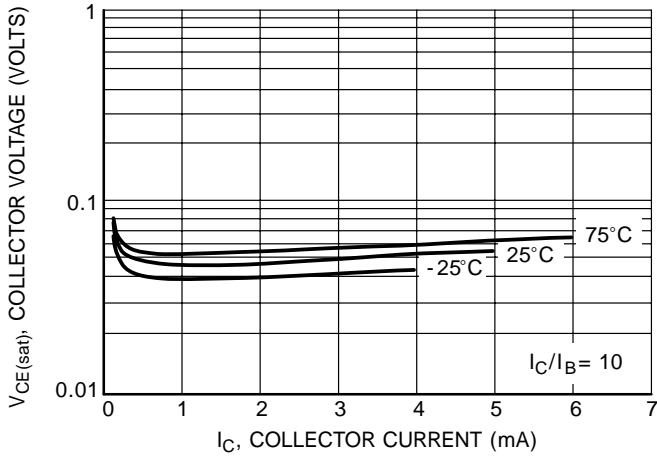

Figure 62. $V_{CE(sat)}$ versus I_C

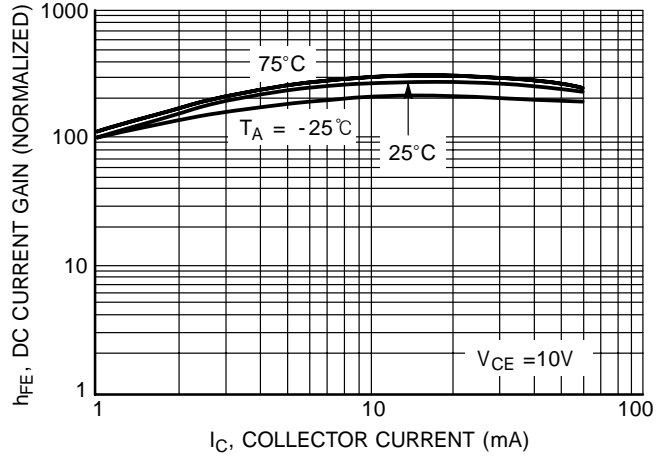

Figure 63. DC Current Gain

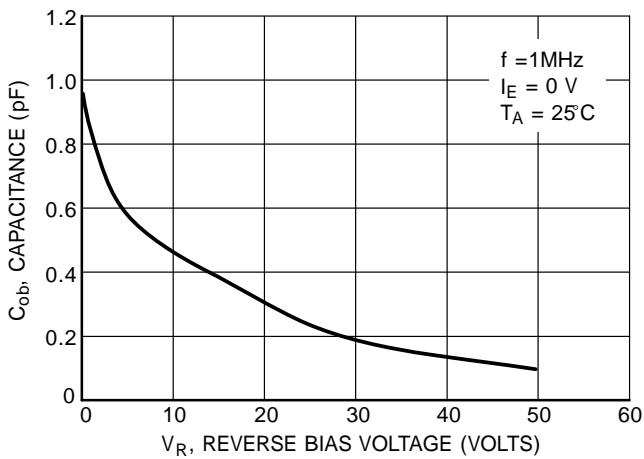

Figure 64. Output Capacitance

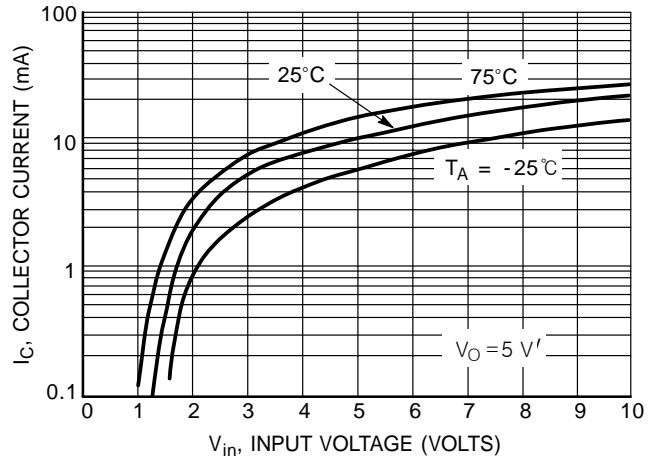

Figure 65. Output Current versus Input Voltage

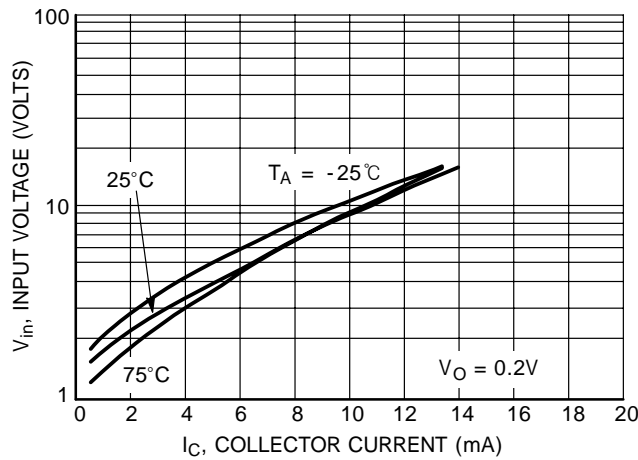

Figure 66. Input Voltage versus Output Current

TYPICAL ELECTRICAL CHARACTERISTICS – DWA409

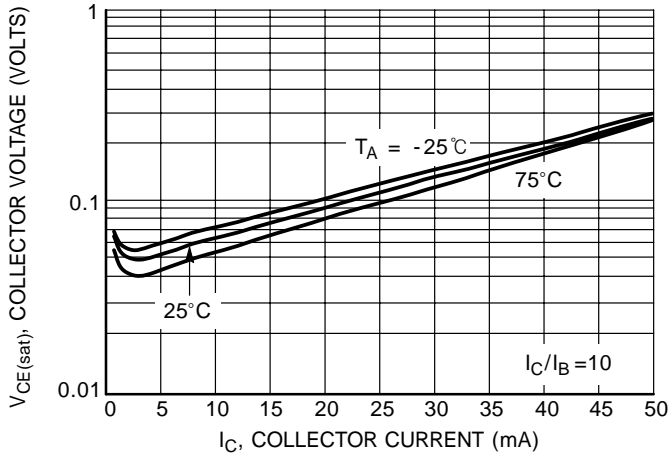

Figure 67. $V_{CE(sat)}$ versus I_C

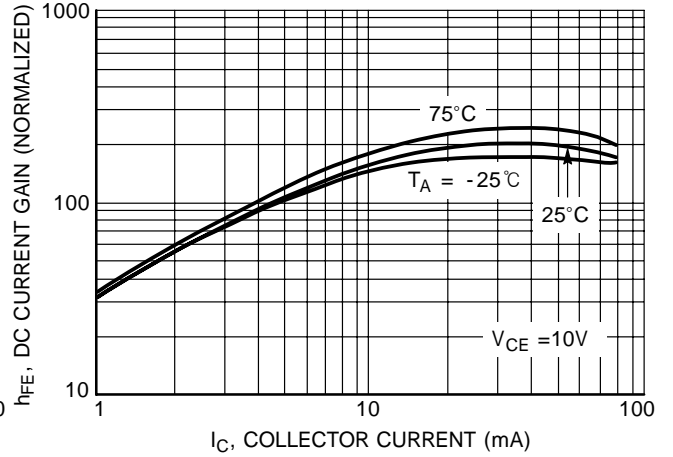

Figure 68. DC Current Gain

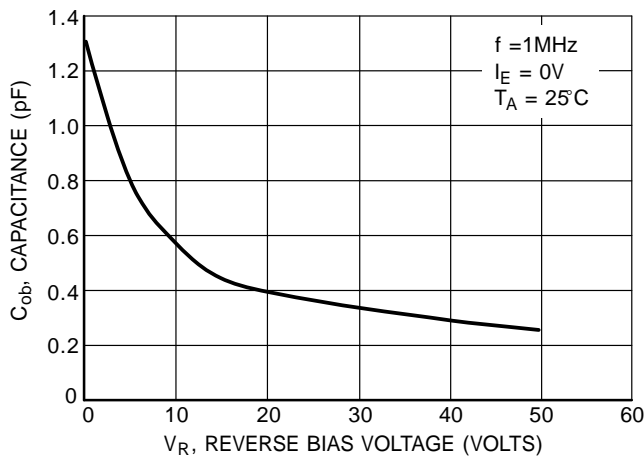

Figure 69. Output Capacitance

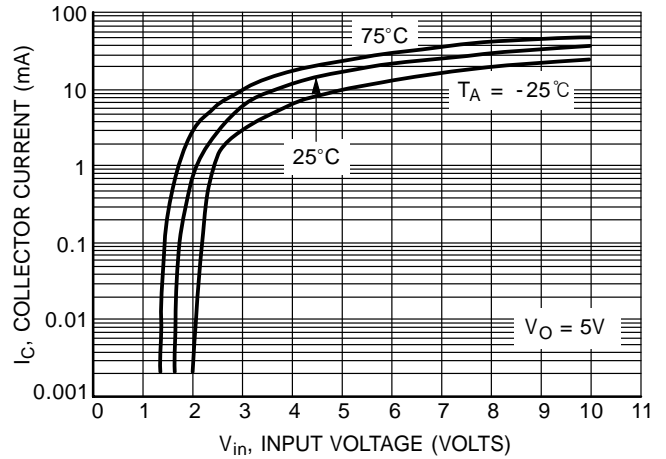

Figure 70. Output Current versus Input Voltage

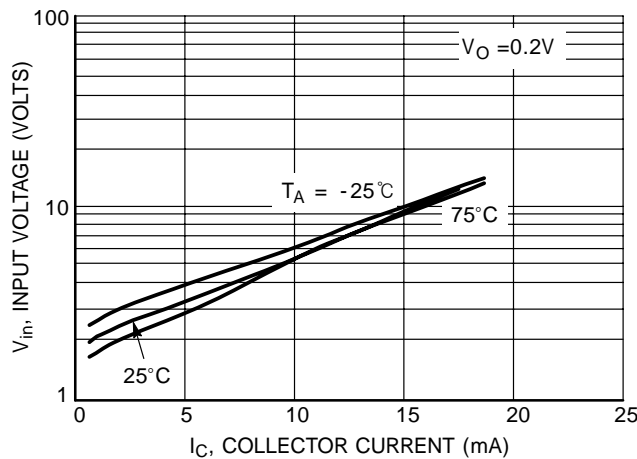
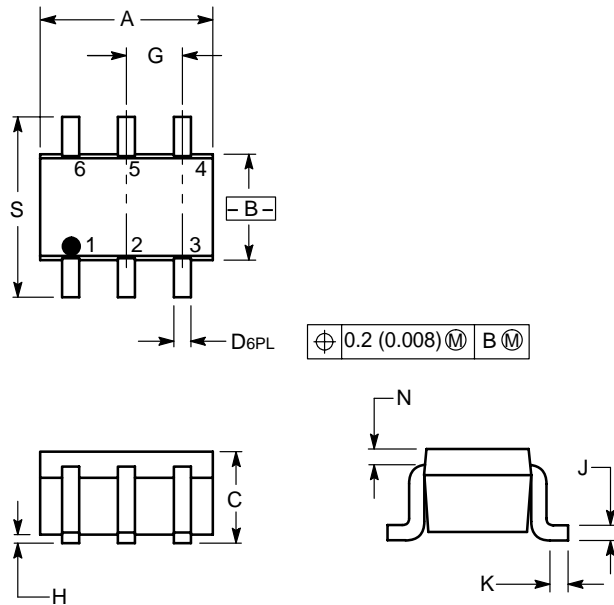

Figure 71. Input Voltage versus Output Current

SC-88/SOT-363

NOTES:

1. DIMENSIONING AND TOLERANCING PER ANSI Y14.5M, 1982.
2. CONTROLLING DIMENSION: INCH.



DIM	INCHES		MILLIMETERS	
	MIN	MAX	MIN	MAX
A	0.071	0.087	1.80	2.20
B	0.045	0.053	1.15	1.35
C	0.031	0.043	0.80	1.10
D	0.004	0.012	0.10	0.30
G	0.026 BSC		0.65 BSC	
H	---	0.004	---	0.10
J	0.004	0.010	0.10	0.25
K	0.004	0.012	0.10	0.30
N	0.008 REF		0.20 REF	
S	0.079	0.087	2.00	2.20

- PIN 1. EMITTER 2
- 2. BASE 2
- 3. COLLECTOR 1
- 4. EMITTER 1
- 5. BASE 1
- 6. COLLECTOR 2

